

2025
2026



AUTHENTIC POWER

Cordless | Pneumatic Solutions

Tools
that matter
for your work



WARNING :

- All the pneumatic tools should only be used as hand operated tools.
- They are powered by compressed air and are not insulated against electric shock.
- Always turn off the air supply and disconnect the air hose before changing or replacing any inserted tool and accessory.
- Before using these tools, make sure that all couplings and plugs are securely fastened. Air hoses which are under pressure may lash out when disconnecting, that can lead to serious injury!
- High sound levels may cause hearing damage.
- Always wear hearing protection when operating this tool.
- Wearing eye/face protection can reduce the danger of high-speed materials being emitted from the tool.
- Make sure that the direction of the spark generated from the cutting wheel grinding wheel or shank stone is properly directed so as to not create a hazard..
- Always wear gloves to reduce risk.
- User must wear proper clothing.
- Loose clothing, long hair, stings, straps, belts and jewelry should not be worn when operating this tool.
- Long periods of prolong use will cause fatigue.
- Periodic breaks are recommended for user safety.
- It is recommended to stop operating the tool whenever discomfort, tingling or pain occurs during use.
- Make sure there is no gas or combustible material stored near the tool when servicing, changing insert tools, or storage.
- Wearing proper breathing protection to avoid inhale dust or handling debris from working process, which can be harmful to the health.





AUTHENTIC POWER

A complete brand experience

As a designer, manufacturer, and distributor, M7 goes beyond merely producing tools – we offer a complete brand experience tailored to the unique requirements of our clients.

Our team is dedicated to supporting our customers with seamless service and expert advice, helping them find the right tools to enhance productivity and performance.

This dedication to service is at the heart of our brand, fostering strong relationships with our global network of distributors and users.

Empowering Professionals Worldwide with Reliable Performance

M7 is a leading global supplier of high-performance pneumatic and cordless power tools, providing a comprehensive range of tools that are built for reliability, efficiency, and ergonomic design.

Our commitment to quality is driven by a deep understanding of the needs of professionals across diverse industries.

We listen closely to our customers, ensuring that our tools meet and exceed their performance expectations, from demanding construction sites to precision-driven workshops.

M7

AUTHENTIC POWER





Global reach & unmatched support

M7 reaches clients on every continent, supported by a robust team of international experts and a passionate group of engineers, designers, and service professionals. Our global presence allows us to quickly respond to the needs of our dealers and customers, ensuring that our high standards of quality and performance are upheld worldwide. With M7, clients have a partner they can rely on for exceptional products and unwavering support, wherever they are.

LEVEL IDENTIFICATION

LEVEL

The air tools in this section have been categorized into three distinctive levels for user convenience (for reference only).



Efficiency / Performance

Easy to use to handle tasks quickly, these tool embody efficiency and performance.



Strength

Tools provide high torque force, superior grinding power and high cutting energy.



Endurance

Built to last, product longevity and low failure rate are characteristics associated with these tools.

MIGHTY SEVEN

APPLICATION

Application icons have been designed to provide visual references that suggest industry specific features or usability. These application icons are for reference only.



Automotive



Industry



Shipbuilding



Motorcycle



Agriculture



Aviation

CONTENT

- 08 - NEW PRODUCT
- 10 - CORDLESS TOOLS
- 20 - GARDEN TOOLS
- 28 - AIR IMPACT WRENCH
- 42 - AIR RATCHET WRENCH
- 47 - AIR DIE GRINDER
- 51 - MICRO AIR DIE GRINDER
- 52 - AIR ANGLE GRINDER
- 56 - AIR BELT SANDER
- 57 - AIR SANDER
- 61 - AIR SQUARE SANDER
- 62 - AIR PISTOL POLISHER
- 64 - AIR CUTTING TOOLS
- 68 - AIR DRILL
- 76 - AIR SCREWDRIVER
- 81 - SPRING BALANCER
- 82 - AIR HAMMER
- 85 - AIR NEEDLE SCALER
- 86 - AIR HYDRAULIC RIVETER
- 89 - RIVETER ADAPTOR/RIVET NUT ADAPTOR
- 90 - AIR NAILER / AIR STAPLER
- 93 - AIR GREASE GUN
- 94 - AIR BLOW GUN
- 95 - AUTO REPAIR TOOL
- 102 - SANDBLASTING GUN
- 103 - FILTER REGULATOR LUBRICATOR
- 105 - AIR HOSE REEL
- 106 - TORQUE WRENCH
- 109 - DIGITAL TORQUE WRENCH
- 114 - IMPACT SOCKET
- 134 - AFTER MARKET SUPPORT
- 136 - DISPLAY CASE
- 137 - ACCESSORIES
- 146 - AIR ADAPTOR / QUICK COUPLINGS
- 148 - POWER BIT
- 150 - MERCHANDISE
- 152 - CATALOGING INFORMATION
- 157 - ALPHABETIC INDEX

NEW PRODUCT

DS-202 CORDLESS IMPACT DRIVER



4 pieces in one carton

- 3 forward functions designed for specific applications: wood, thin iron sheets, and thick iron sheets.
- Reverse loose stop function for added convenience.
- Compact overall length of 110 mm.
- Bare tool weight of only 1.0 kg.

Chuck Size	1/4" / 6 (mm)
Bolt Capacity	M5-M12
Max. Torque	200 (ft-lb) / 270 (Nm)
No Load Speed (RPM)	0-1200 / 0-1900 / 0-2500 / 0-3200
Impact Rate (IPM)	0-1400 / 0-1800 / 0-3500 / 0-4000
Weight (bare tool)	1.0 (kg) / 2.2 (lbs)
Rating Voltage	18 (V)
Completely Charged Battery	20 (V) Li-ion 5.0 / 2.5 Ah

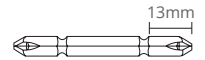

DS-203 CORDLESS IMPACT DRIVER



4 pieces in one carton

- 3 forward functions (BIT): optimized for wood, thin iron sheets, and thick iron sheets.
- Reverse loose stop function for improved control.
- Compact overall length of 125 mm.
- Bare tool weight of only 1.0 kg.
- The DS-203 is compatible with a 1/2" impact socket.

Square Drive	1/2" / 12.7 (mm)
Max. Torque	F: 400 R: 430 (ft-lb) F: 540 R: 583 (Nm)
Chuck Size	1/4" / 6 (mm)
Bolt Capacity	M5-M12
Max. Torque	200 (ft-lb) / 270 (Nm)
No Load Speed (RPM)	0-1200 / 0-1900 / 0-2500 / 0-3200
Impact Rate (IPM)	0-1400 / 0-1800 / 0-3500 / 0-4000
Weight (bare tool)	1.0 (kg) / 2.2 (lbs)
Rating Voltage	18 (V)
Completely Charged Battery	20 (V) Li-ion 5.0 / 2.5 Ah

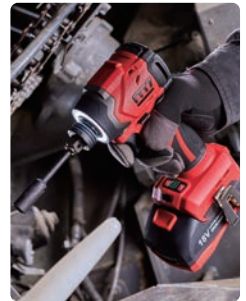

DDWV-104[KIT] CORDLESS BRUSHLESS VACUUM CLEANER

1 pieces in one carton

- Automatic Stop When Full: Automatically halts operation when water reaches maximum capacity, protecting the motor.
- Switchable to Blowing Mode: Ideal for clearing debris from hard-to-reach areas.
- Extended Telescopic Hose: 3.2 meters for added reach and flexibility.
- Working Time: High Power: 20 minutes; Low Power: 35 minutes (Based on 5.0Ah battery pack).
- Shoulder Strap and Swivel Wheels: Enhances portability and ease of use.
- Capacity: Holds up to 10L of dry waste or 8L of wastewater.

Maximum Suction Power (Low Gear)	9 (kpa)
Maximum Suction Power (High Gear)	16 (kpa)
Capacity (Water)	8 (L)
Capacity (Dust)	10 (L)
Telescopic Pipe Length	3.2 (M)
Run time (Low Gear)	35 (min)
Run time (High Gear)	20 (min)
Weight (bare tool)	4.1 (kg) / 9.1 (lbs)
Rating voltage	18 (V)
Completely charged	20 (V)



DDWV-900F
HEPA filter



DDWV-901
4 Rotary wheels



DDWV-902
Big brush & 3 pcs plastic tubes



DDWV-903
Nozzle



DDWV-904
Soft tube



DDWV-905
Strap

DGS-101

CORDLESS BACKPACK SPRAYER

1 pieces in one carton

- Two-stage pressure adjustment function.
- Real-time stable atomization output ensures consistent performance.
- Carrying strap design provides lightweight and convenient usage.

Pressure	4.0 (bar) / 5.0 (bar)
Tank Capacity	12 (L)
Flow Rate	1.2 (L/min)
Weight (bare tool)	3.4 (kg) / 7.5 (lbs)
Rating Voltage	18 (V)
Completely Charged	20 (V)
Battery	Li-ion 5.0 Ah
Plastic Lance length	58 (cm)
Flexible Hose length	124 (cm)



a. 1.1 L/MIL b. 1.7 L/MIL c. 1.9 L/MIL



d. 1.2 L/MIL e. 1.7 L/MIL

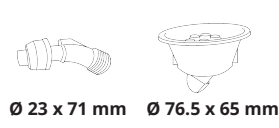

DWL-101

WORK LIGHT

2 pieces in one carton

- Battery: 5.0 Ah Li-ion
- Bulb Type: COB LED
- AC/DC Adaptor: 18V 2A
- Modes: Low / OFF / High / OFF
- Size: 250 x 140 x 300 mm
- Weight: 2400 g
- Waterproof Rating: IPX4

Max output lm and Run time	
Low mode	High mode
battery pack 1000 lm @ 6 hrs	battery pack 6000 lm @ 3 hrs
AC 900 lm	AC 3200 lm



DWL-102

WORK LIGHT

2 pieces in one carton

- Battery: 5.0 Ah Li-ion
- Bulb Type: White SMD & Warm SMD LED
- AC/DC Adaptor : 18V 2A
- Modes: Low / OFF / High / OFF
- Size : 180x145x440 mm
- Weight: 2850 g
- Waterproof Rating: IPX4

		Max output	Run time
battery pack	White	2000 lm / 7000 lm	7.5 Hrs / 2.5 Hrs
	Warm	2000 lm / 7000 lm	7.5 Hrs / 2.5 Hrs
AC	White	1000 lm / 3500 lm	---



NEW PRODUCT

I DLB-102

CORDLESS LEAF BLOWER

2 pieces in one carton

- Two Air Ducts: Designed for easy installation and efficient airflow.
- Ergonomic Handle: Features a soft grip for enhanced comfort during use.
- Electronic Signal Switch: Provides easy and precise control.
- Versatile Applications: Suitable for lawn grooming, snow removal, and dust removal.

Air speed	45 (m/s)
Air capacity	460 (CFM)
Weight (bare tool)	2.6 (kg) / 5.7 (lbs)
Rating Voltage	18 (V)
Completely Charged	20 (V)
Battery	Li-ion 5.0 Ah



I DCCS-101

CORDLESS CHAIN SAW

2 pieces in one carton

- Mechatronic Safety Trigger.
- Tool-less Adjustment: Features a double-switch safety trigger and anti-self-locking switch.
- Rubber Sleeve Design: Reduce vibration during use.
- Brushless Motor: Offers greater efficiency, durability, and performance.
- Tool-Free Chain Adjustment: Allows for quick and easy chain adjustments.
- Automatic Chain Lubrication System: Ensures smoother and more efficient cutting while extending the tool's service life.

Load Speed	9.3 (m/s)
Guard Length	10" / 254 (mm)
Cut Size	7.87" / 200 (mm)
Weight	2.7 (kg) / 6.0 (lbs)
Rating Voltage	18 (V)
Completely Charged	20 (V)
Battery	Li-ion 5.0 Ah



I DHT-101

CORDLESS HEDGE TRIMMER TOOL

1 pieces in one carton

- Double-Switch Safety Trigger.
- Ergonomic design of the handle.
- Handle knob with 5 positions can be adjusted at any time to meet the user's needs.
- Maximum cutting diameter of the blade is 19 mm, blade length is 20".

No Load Speed (SPM)	1400
Blade Length	24" / 610 (mm)
Cutting Diameter	3/4" / 19 (mm)
The handle can be rotated	45° & 90°
Weight (bare tool)	2.6 (kg) / 5.7 (lbs)
Rating Voltage	18 (V)
Completely Charged	20 (V)
Battery	Li-ion 5.0 Ah



DST-101

CORDLESS STRING TRIMMERS

2 pieces in one carton

- 300mm cut path with 2mm dual-line bump feed.
- Adjustable Auxiliary Handle.
- Foldable pole for easier storage.

Cutting Width	300 (mm)
Line Advance System	Bump Feed
Cutting-line Type	2 (mm). Twisted nylon line
No Load Speed (RPM)	5800-7000
Weight (bare tool)	2.6 (kg) / 5.7 (lbs)
Tool length	876 (mm)
Rating Voltage	18 (V)
Completely Charged	20 (V)
Battery	Li-ion 5.0 Ah



DGM-101

CORDLESS GARDEN MULTI-HEAD TOOLS

1 pieces in one carton

- Multi-Function Quick-Change Head: Allows for versatile applications and easy tool adjustments.
- Double-Action Switch: Prevents accidental operation.
- Tool with Lifting Ring: Includes a shell installation strap for easier operation.

No Load Speed	7400 (RPM)
Cutting Brush Speed	6900 (RPM)
Grassing Speed	6900 (RPM)
High Branch Shear Speed	2400 (SPM)
Cutting Diameter	10 (mm)
Rating Voltage	36 (V): 2pcs 18V batteries
Completely Charged	40 (V): 2pcs 18V batteries
Battery	Li-ion 5.0 Ah



DGM-901
Pole saw head



DGM-902
Brush cutter head



DGM-903
Hedge trimmer head



DGM-904
String trimmer head

AD-316

TABLE DISPLAY FOR CORDLESS TOOL (2 Sets)



DC-101

18V 6A CHARGER 100~240Vac (For DB-1850P /DB-1825)



DC-201

18V 6A CHARGER 100~240Vac (For DB-1850P /DB-1825)



NEW PRODUCT

NC-6610Q

3/4"DRIVE AIR IMPACT WRENCH Jumbo hammer type



10 pieces in one carton



NC-488

1/2"DRIVE AIR IMPACT WRENCH Jumbo hammer type



8 pieces in one carton

Toolless: Fast and easy, select the desired angle by bare hands.
No loosening worry: Intelligent chaining design ensures the chosen angle is fixed and secured.



The Adjustable Head with Angle Lock 160°- The widest adjusting angle in the market.

Item No.	Square Drive		Bolt Capacity	Torque Range		Max Torque		No Load Speed	Avg. Air Consumption	Air Pressure	Overall Length		Net Weight		Air Hose	Sound Pressure	Vibration Level	Air Inlet
	Inch	Inch (mm)		ft-lb (Nm)	ft-lb	Nm	R.P.M	CFM (L/min)	PSI (bar)	Inch (mm)	LBS	kg	Inch		dBA	m/s ²	Inch	
NC-488	1/2"	5/8"(16)		100-450(136-610)	500	678	9000	5.0(142)	90(6.3)	11-1/4"(284)	3.7	1.7	3/8"		93.0	4.3	1/4"	
NC-6610Q	3/4"	1-1/8"(27)		150-900(203-1220)	1300	1762	7000	5.1(144)	90(6.3)	5-7/16"(138)	4.0	1.8	3/8"		85.0	3.1	1/4"	

SC-9501R

1/2"Dr.Air hammer socket adaptor, round shank



SC-9502R

Air impact chisel : radius milled R9, round shank



SC-9503R

Air impact chisel : head Dia 25mm even, round shank



SC-0206R

6-Piece Air Hammer Drifts Set, Length=177mm



SC-9301R Air hammer drift punch 5.2mm, punching bag



SC-9302R Air hammer drift punch 6.5mm, punching bag



SC-9303R Air hammer drift punch 6.9mm, punching bag



SC-9304R Air hammer drift punch 7.7mm, punching bag



SC-9305R Air hammer drift punch 9.3mm, punching bag



SC-9306R Air hammer drift punch 12.3mm, punching bag

1/2"ME473M

HEX BALL DRIVE IMPACT SOCKET

M7 NO.	Hex	D2	L	Weight	Box
		mm	mm	g	
ME473M04	H4	25	78	78	---
ME473M05	H5	25	78	82	---
ME473M06	H6	25	78	86	---
ME473M07	H7	25	78	90	---
ME473M08	H8	25	78	93	---
ME473M10	H10	25	78	105	---
ME473M12	H12	25	78	118	---
ME473M14	H14	25	78	131	---
ME473M15	H15	25	78	140	---
ME473M16	H16	25	78	151	---
ME473M17	H17	25	78	161	---
ME473M18	H18	25	78	171	---
ME473M19	H19	25	78	182	---



3/4"ME673M

IMPACT HEX BALL BIT SOCKET

M7 NO.	Hex	D2	L	Weight	Box
		mm	mm	g	
ME673M14	H14	44	100	463	---
ME673M17	H17	44	100	489	---
ME673M19	H19	44	100	508	---
ME673M21	H21	44	100	540	---
ME673M22	H22	44	100	554	---
ME673M24	H24	44	100	588	---
ME673M27	H27	44	100	643	---
ME673M30	H30	44	100	701	---
ME673M32	H32	44	100	741	---



★★★  **GBI-403030**
1/2" Bluetooth Rechargeable Digital Torque Wrench
 6 pieces in one carton Accuracy: clockwise +/- 1.5% counterclockwise +/- 2.5%

★★★  **GBI-406060**
1/2" Bluetooth Rechargeable Digital Torque Wrench
 6 pieces in one carton Accuracy: clockwise +/- 2% counterclockwise +/- 3%

★★★  **GBI-434340**
1/2" Bluetooth Rechargeable Digital Torque Wrench
 4 pieces in one carton Accuracy: clockwise +/- 2% counterclockwise +/- 3%

- Bluetooth app allows the transmission and assessment of torque values to be faster and more immediate.
- Interchangeable torque head for different workstations.
- Adjustable torque values for 4 types.

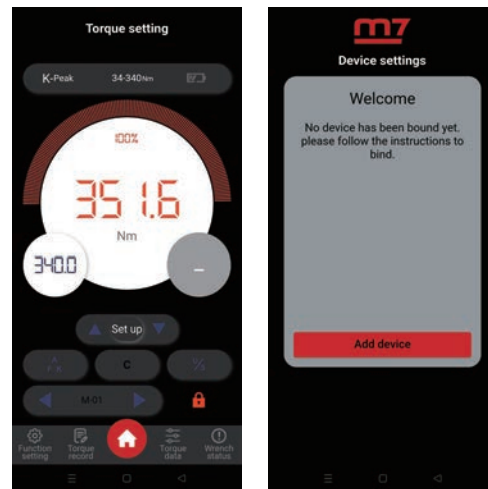

▲ Mobile app mockup



Apple Store Google Play

LED operation display panel.



USB charging (Type C).

★★★  **GDI-403030**
1/2" Interchangeable Digital Torque Wrench
 6 pieces in one carton Accuracy: clockwise +/- 2% counterclockwise +/- 3%



★★★  **GDI-406060**
1/2" Interchangeable Digital Torque Wrench
 6 pieces in one carton Accuracy: clockwise +/- 2% counterclockwise +/- 3%



★★★  **GDI-434340**
1/2" Interchangeable Digital Torque Wrench
 4 pieces in one carton Accuracy: clockwise +/- 2% counterclockwise +/- 3%



★★★  **TI-2105025 KIT**
Interchangeable Torque Wrench Tool
 1 pieces in one carton

- 1pc - Torque Wrench 5-25Nm / 53.1-212.4 IN-LB
- 1pc - Open ended Insert tool: 10mm,13mm,17mm
- 1pc - Ring Insert tool: 10mm,13mm,17mm
- 1pc - 1/4"dr. 72T ratchet Insert tool



★★★  **TI-4204020 KIT**
Interchangeable Torque Wrench Tool
 1 pieces in one carton

- 1pc - Torque Wrench 40-200Nm
- 1pc - Open ended Insert tool: 13mm,14mm,15mm,17mm,19mm,22mm,24mm,27mm,30mm
- 1pc - 1/2"dr. 72T ratchet Insert tool



Item No.	Drive	Gear	Torque Range		Indicator	Torque Adjusting	D	H	L	Weight
	Inch	T	Nm	ft-lb	LCD	Digital	mm	mm	mm	kg
GBI-403030	1/2"	72	3-30	2.22-22.13	LCD	Digital	38	40	435	1.1
GBI-406060	1/2"	72	6-60	4.4-44.3	LCD	Digital	38	40	435	1.1
GBI-434340	1/2"	72	34-340	25-250	LCD	Digital	38	40	644	1.4
GDI-403030	1/2"	72	3-30	2.22-22.13	LCD	Digital	38	40	435	1.1
GDI-406060	1/2"	72	6-60	4.4-44.3	LCD	Digital	38	40	435	1.1
GDI-434340	1/2"	72	34-340	25-250	LCD	Digital	38	40	644	1.4

The slide rail design can be more seamlessly integrated with the tool.

Press the button for easy disassembly and quick replacement. The button's lifespan exceeds 50,000 presses.

Equipped with a built-in BMS control system to extend battery life.

The impact-resistant Nylon+GF30 % shell enhances battery protection and has successfully passed a 1.2-meter drop test.

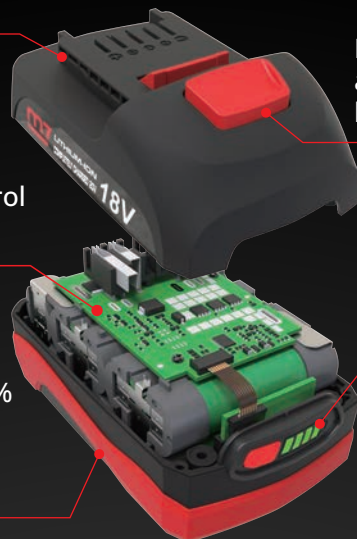

LED fuel gauge indicator.

- 80-100% Capacity
- 60-79% Capacity
- 40-59% Capacity
- 20-39% Capacity
- ○ ○ Under 20% Capacity
- ✱ ✱ ✱ ✱ Under Voltage protected
- ✱ ✱ ○ Temperature protected

Compatible with all M7 DC 18V Cordless tools

The battery features protections against low voltage, overcurrent, overheating, unbalance, external shorted, and low power consumption. The terminal design by clamp reduces contact resistance and enhances tool performance.

DB-1850P

18V 5.0Ah LI-ION BATTERY

20 pieces in one carton



DB-1825

18V 2.5Ah LI-ION BATTERY

20 pieces in one carton



DC-18A

18V BATTERY CHARGER

10 pieces in one carton

18V Li-ion Battery Charger
(For DB-1825/DB-1850/DB-1850P)



DC-101

18V 6A CHARGER
100-240Vac

(For DB-1850P /DB-1825)



NEW

DC-201

18V 6A DUAL PORT
100-240Vac

(For DB-1850P /DB-1825)



NEW

SMALL . LIGHT . POWERFUL!

CORDLESS TOOLS

CORDLESS TOOLS

DW-1840

CORDLESS IMPACT WRENCH

5 pieces in one carton

- Max. torque 900 ft-lb / 1220 Nm.
- Includes 2pcs* 5.0 Ah batteries for extended usage time.
- Tool with an LED light to illuminate the working area.
- Features a braking function to prevent damage to the screwed object.

Square Drive	1/2" / 12.7 (mm)
Bolt Capacity	M6-M24
Max. Torque	900 (ft-lb) / 1220 (Nm)
No Load Speed (RPM)	0-1900
Impact Rate (IPM)	0-2200
Weight (bare tool)	3.2 (kg) / 7.0 (lbs)
Rating Voltage	18 (V)
Completely Charged	20 (V)
Battery	Li-ion 5.0 Ah



DW-18502A[KIT]

CORDLESS IMPACT WRENCH

3 pieces in one carton

- 2pcs 5.0Ah Li-ion battery
- 1pc charger



DW-401

CORDLESS IMPACT WRENCH

4 pieces in one carton

- 3-speed torque selection enables users to optimize tool performance for specific applications.
- The auto-stop function automatically shuts down the tool, minimizing the risk of overdriving and material damage.
- Impact rate: 0-1,500 / 0-2,500 / 0-3,000 IPM, delivering up to 600 ft-lb of torque.

Square Drive	1/2" / 12.7 (mm)
Bolt Capacity	M16
Max. Torque	600 (ft-lb) / 813 (Nm)
No Load Speed (RPM)	0-1100 / 0-1600 / 0-2200
Impact Rate (IPM)	0-1500 / 0-2500 / 0-3000
Weight (bare tool)	1.5 (kg) / 3.3 (lbs)
Rating Voltage	18 (V)
Completely Charged	20 (V)
Battery	Li-ion 5.0 Ah



DW-401A[KIT]

CORDLESS IMPACT WRENCH

3 pieces in one carton

- 2pcs 5.0Ah Li-ion battery
- 1pc charger



DW-402

CORDLESS IMPACT WRENCH

3 pieces in one carton

- The BL Motor delivers a maximum torque of 1,000 ft-lbs and a breakaway torque of 1,250 ft-lbs.
- A 3-speed power selection switch (0-900 / 0-1,000 / 0-1,700 RPM & 0-1,800 / 0-2,000 / 0-2,200 IPM) provides precise fastening control.
- Features a 1/2" anvil with a friction ring for quick and easy socket changes.
- The BL Brushless Motor eliminates carbon brushes, allowing it to run cooler and more efficiently for a longer lifespan.
- The electronically controlled BL Brushless Motor optimizes battery energy usage, delivering up to 50% longer run time per charge.
- For enhanced performance, use the DB-1850P battery.

Square Drive	1/2" / 12.7 (mm)
Bolt Capacity	M10-M24
Max. Torque	1250 (ft-lb) / 1700 (Nm)
No Load Speed (RPM)	0-900 / 0-1000 / 0-1700
Impact Rate (IPM)	0-1800 / 0-2000 / 0-2200
Weight (bare tool)	3.3 (kg) / 7.3 (lbs)
Rating Voltage	18 (V)
Completely Charged	20 (V)
Battery	Li-ion 5.0 Ah



Patented Shock Absorption Body

DW-402A[KIT]

CORDLESS IMPACT WRENCH

2 pieces in one carton

- 2pcs 5.0Ah Li-ion battery
- 1pc charger



DW-404

CORDLESS IMPACT WRENCH



10 pieces in one carton

- 4-speed power selection offers precise fastening control.
- Tool with a reverse loose stop mode for added convenience.
- The bare tool weighs only 1.2 kg, ensuring lightweight and easy handling.

Square Drive	1/2" / 12.7 (mm)
Bolt Capacity	M6-M16
Max. Torque	660 (ft-lb) / 900 (Nm)
No Load Speed (RPM)	0-900 / 0-1400 / 0-1800 / 0-2200
Impact Rate (IPM)	0-1150 / 0-1700 / 0-2300 / 0-2500
Overall Length	130 (mm)
Weight (bare tool)	1.2 (kg) / 2.6 (lbs)
Rating Voltage	18 (V)
Completely Charged Battery	20 (V) Li-ion 5.0 Ah



DW-404A[KIT]

CORDLESS IMPACT WRENCH

4 pieces in one carton

- 2pcs 5.0Ah Li-ion battery
- 1pc charger



DW-406

CORDLESS IMPACT WRENCH



8 pieces in one carton

- 3-speed power selection ensures precise fastening control.
- Features a reverse loose stop mode for added functionality.
- The bare tool weighs only 2 kg, offering a balanced and manageable design.

Square Drive	1/2" / 12.7 (mm)
Bolt Capacity	M10-M25
Max. Torque	1200 (ft-lb) / 1600 (Nm)
No Load Speed (RPM)	0-1400 / 0-1900 / 0-2400
Impact Rate (IPM)	0-1800 / 0-2000 / 0-2800
Overall Length	172 (mm)
Weight (bare tool)	2.0 (kg) / 4.4 (lbs)
Rating Voltage	18 (V)
Completely Charged Battery	20 (V) Li-ion 5.0 Ah



DW-601

CORDLESS IMPACT WRENCH



3 pieces in one carton

- The BL Motor delivers up to 1,000 ft. lbs. of maximum torque and 1,400 ft. lbs. of breakaway torque.
- A 3-speed power selection switch (0-900 / 0-1,000 / 0-1,700 RPM & 0-1,800 / 0-2,000 / 0-2,200 IPM) provides precise fastening control.
- Features a 3/4" anvil with a friction ring for quick and easy socket changes.
- The BL Brushless Motor eliminates carbon brushes, allowing it to run cooler and more efficiently, ensuring a longer lifespan.
- The efficient BL Brushless Motor is electronically controlled to optimize battery energy use, delivering up to 50% longer run time per charge.
- For enhanced performance, use the DB-1850P battery.

1900 Nm

Square Drive	3/4" / 19 (mm)
Bolt Capacity	M10-M27
Max. Torque	1400 (ft-lb) / 1900 (Nm)
No Load Speed (RPM)	0-900 / 0-1000 / 0-1700
Impact Rate (IPM)	0-1800 / 0-2000 / 0-2200
Weight (bare tool)	3.4 (kg) / 7.4 (lbs)
Rating Voltage	18 (V)
Completely Charged Battery	20 (V) Li-ion 5.0 Ah

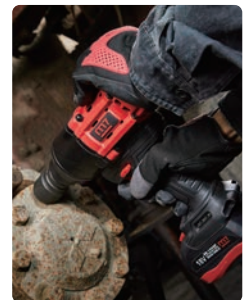

Patented Shock Absorption Body

CORDLESS TOOLS

CORDLESS TOOLS

DS-10202A

CORDLESS IMPACT DRIVER

5 pieces in one carton

- Max Torque: 73 ft-lb / 100 Nm.
- Battery: Includes 2 pieces for extended usage time.
- LED light: Illuminates the working area for better visibility.
- Compatibility: Battery is applicable to all M7 10.8V cordless models.

Chuck Size (Hex)	1/4" / 6.35 (mm)
Bolt Capacity	M4-M12
Max. Torque	73 (ft-lb) / 100 (Nm)
No Load Speed (RPM)	0-2200
Impact Rate (IPM)	0-3000
Weight	1.0 (kg) / 2.2 (lbs)
Rating Voltage	10.8 (V)
Completely Charged	12 (V)
Battery	Li-ion 2.0 Ah



DS-201

CORDLESS IMPACT DRIVER

4 pieces in one carton

- 3-speed torque selection enables users to match the tool's performance to the application.
- The auto-stop function automatically shuts down the tool, minimizing the risk of overdriving and material damage.
- Impact rate: 0-1,200 / 0-2,350 / 0-3,300 IPM, delivering up to 150 ft. lbs. of torque.

Chuck Size (Hex)	1/4" / 6.35 (mm)
Bolt Capacity	M12
Max. Torque	150 (ft-lb) / 203 (Nm)
No Load Speed (RPM)	0-1100 / 0-1900 / 0-2800
Impact Rate (IPM)	0-1200 / 0-2350 / 0-3300
Weight (bare tool)	1.3 (kg) / 2.8 (lbs)
Rating Voltage	18 (V)
Completely Charged	20 (V)
Battery	Li-ion 5.0 Ah



DS-202 **NEW**

CORDLESS IMPACT DRIVER

4 pieces in one carton

- 3 forward functions designed for specific applications: wood, thin iron sheets, and thick iron sheets.
- Reverse loose stop function for added convenience.
- Compact overall length of 110 mm.
- Bare tool weight of only 1.0 kg.

Chuck Size (Hex)	1/4" / 6 (mm)
Bolt Capacity	M5-M12
Max. Torque	200 (ft-lb) / 270 (Nm)
No Load Speed (RPM)	0-1200 / 0-1900 / 0-2500 / 0-3200
Impact Rate (IPM)	0-1400 / 0-1800 / 0-3500 / 0-4000
Weight (bare tool)	1.0 (kg) / 2.2 (lbs)
Rating Voltage	18 (V)
Completely Charged	20 (V)
Battery	Li-ion 5.0 / 2.5 Ah



DS-202A[KIT]

CORDLESS IMPACT DRIVER

4 pieces in one carton

- 2pcs 5.0Ah Li-ion battery
- 1pc charger

DS-203 **NEW** Motor BRUSHLESS CORDLESS IMPACT DRIVER

4 pieces in one carton

- 3 forward functions (BIT): optimized for wood, thin iron sheets, and thick iron sheets.
- Reverse loose stop function for improved control. Compact overall length of 125 mm.
- Bare tool weight of only 1.0 kg.
- The DS-203 is compatible with a 1/2" impact socket.

Square Drive	1/2" / 12.7 (mm)
Max. Torque	F: 400 R: 430 (ft-lb) F: 540 R: 583 (Nm)
Chuck Size (Hex)	1/4" / 6 (mm)
Bolt Capacity	M5-M12
Max. Torque	200 (ft-lb) / 270 (Nm)
No Load Speed (RPM)	0-1200 / 0-1900 / 0-2500 / 0-3200
Impact Rate (IPM)	0-1400 / 0-1800 / 0-3500 / 0-4000
Weight (bare tool)	1.0 (kg) / 2.2 (lbs)
Rating Voltage	18 (V)
Completely Charged	20 (V)
Battery	Li-ion 5.0 / 2.5 Ah



DS-203A[KIT] Motor BRUSHLESS CORDLESS IMPACT DRIVER

4 pieces in one carton

- 2pcs 5.0Ah Li-ion battery
- 1pc charger

DD-101 Motor BRUSHLESS CORDLESS DRILL DRIVER

3 pieces in one carton

- Impulse function is perfect for pilot drilling on glossy surfaces and removing damaged screws.
- Features a 1/2" ratcheting single-sleeve metal keyless chuck for effortless bit changes.
- LED light: Illuminates the working area for better visibility.
- Electric brake quickly halts chuck rotation for enhanced safety and efficiency.

Chuck Size	1/2" / 13 (mm)
Max. Torque	73 (ft-lb) / 90 (Nm)
Max. Drill Capacity	steel 13 / wood 60 (Nm)
No Load Speed (RPM)	0-500 / 0-2000
Torque setting	23+1
Weight (bare tool)	1.4 (kg) / 3.0 (lbs)
Rating Voltage	18 (V)
Completely Charged	20 (V)
Battery	Li-ion 5.0 Ah



DD-101A[KIT] Motor BRUSHLESS CORDLESS DRILL DRIVER

2 pieces in one carton

- 2pcs 5.0Ah Li-ion battery
- 1pc charger
- 1pc auxiliary handle

DH-101 Motor BRUSHLESS CORDLESS HAMMER DRILL DRIVER

3 pieces in one carton

- Impulse function is perfect for pilot drilling on glossy surfaces and removing damaged screws.
- Features a 1/2" ratcheting single-sleeve metal keyless chuck for effortless bit changes.
- LED light: Illuminates the working area for better visibility.
- The electric brake ensures rapid stopping of chuck rotation for added safety and precision.

Chuck Size	1/2" / 13 (mm)
Max. Torque	73 (ft-lb) / 90 (Nm)
Max. Drill Capacity	steel 13 / wood 50 (Nm)
No Load Speed (RPM)	0-500 / 0-2000
Torque setting	23+1+1
Weight (bare tool)	1.5 (kg) / 3.2 (lbs)
Rating Voltage	18 (V)
Completely Charged	20 (V)
Battery	Li-ion 5.0 Ah



• Note : This tool is attached an auxiliary handle

• Note : This tool is attached an auxiliary handle

CORDLESS TOOLS

DRH-101 CORDLESS ROTARY HAMMER



5 pieces in one carton

- Three operating modes: Drill, Impact, and Chisel.
- Rotation Stop Mode: Enhances versatility by allowing chiseling applications without rotation.
- LED light: Illuminates the working area for better visibility.
- Includes an auxiliary handle for improved control and comfort during operation.

Chuck Type	SDS Plus
Impact Energy	2.6 (J)
No Load Speed (RPM)	1150
Impact Rate (BPM)	5100
Weight (bare tool)	2.8 (kg) / 6.2 (lbs)
Rating Voltage	18 (V)
Completely Charged Battery	20 (V) Li-ion 5.0 Ah



DRH-101A[KIT] CORDLESS ROTARY HAMMER

2 pieces in one carton

- 2pcs 5.0Ah Li-ion battery
- 1pc charger



DRS-101 CORDLESS RECIPROCATING SAW



3 pieces in one carton

- Blade stroke: 1-1/8" (29mm).
- LED work light with pre-light and afterglow.
- Electric brake quickly stops the blade rotation when the trigger is released.
- Bevel Gear Drive System.
- Tool-less Blade Change.

Stroke Length	1-1/8" / 29 (mm)
Strokes Per min	0-3100
Cutting Capacity	wood 200 / steel 20 (mm)
Overall Length	16-1/7" / 410 (mm)
Weight (bare tool)	2.7 (kg) / 6.0 (lbs)
Rating Voltage	18 (V)
Completely Charged Battery	20 (V) Li-ion 5.0 Ah



DRS-101A[KIT] CORDLESS RECIPROCATING SAW

3 pieces in one carton

- 2pcs 5.0Ah Li-ion battery
- 1pc charger
- Packaging: Color Box

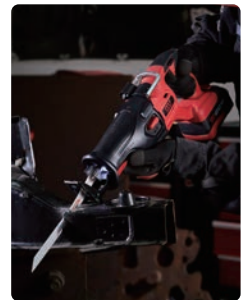

DRS-102 CORDLESS RECIPROCATING SAW



3 pieces in one carton

- Tool-Less Shoe Adjustment: Allows for quick and easy setup, enhancing user convenience.
- LED light: Illuminates the working area for better visibility.
- Stops the blade instantly when the trigger is released, ensuring enhanced safety and control.
- Tool with a safety lock button for added operational security.

Stroke Length	25 (mm)
Strokes Per min	0-3100
Cutting Capacity	wood 160 / steel 16 (mm)
Overall Length	13-3/13" / 335 (mm)
Weight (bare tool)	1.8 (kg) / 3.9 (lbs)
Rating Voltage	18 (V)
Completely Charged Battery	20 (V) Li-ion 5.0 Ah



DRS-102A[KIT] CORDLESS RECIPROCATING SAW

3 pieces in one carton

- 2pcs 5.0Ah Li-ion battery
- 1pc charger
- Packaging: BMC

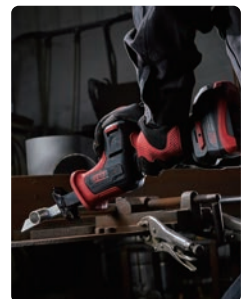

DOM-101

CORDLESS OSCILLATING MULTIT-TOOL



6 pieces in one carton

- Maximum oscillations per minute: 18,000.

Minimum Oscillations	11000 (per minute)
Maximum Oscillations	18000 (per minute)
Oscillation Angle	1.8°
Tool Length	320 (mm)
Weight (bare tool)	1.0 (kg) / 2.3 (lbs)
Rating Voltage	18 (V)
Completely Charged	20 (V)
Battery	Li-ion 5.0 Ah

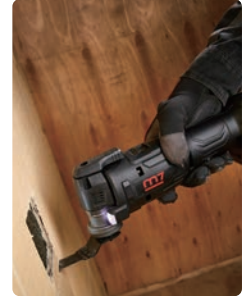

DOM-101A[KIT]

CORDLESS OSCILLATING MULTIT-TOOL

3 pieces in one carton

- 2pcs 5.0Ah Li-ion battery
- 1pc charger

DJS-101

CORDLESS JIG SAW



3 pieces in one carton

- Variable speed trigger offers precise speed and control for various applications.
- Electric brake quickly halts blade motion for enhanced safety and efficiency.
- 4-position orbital action provides cutting versatility across a range of materials.
- Adjustable shoe bevels from 0° to 45° (left/right) for angled cuts.
- Tool-less blade change allows for quick blade swaps and supports both "T" and "U" shank jigsaw blades.
- LED light: Illuminates the working area for better visibility.

Stroke Length	25 (mm)
Strokes Per min	0-2200
Cutting Capacity	wood 2-1/2" / 63 (mm)
Cutting Capacity	steel 1/4" / 6.0 (mm)
Cutting Capacity	aluminum 3/8" / 9.53 (mm)
Overall Length	410 (mm)
Weight (bare tool)	2.7 (kg) / 5.9 (lbs)
Rating Voltage	18 (V)
Completely Charged	20 (V)
Battery	Li-ion 5.0 Ah



SUITABLE FOR BOTH T & U SHANK



DJS-101A[KIT]

CORDLESS JIG SAW

3 pieces in one carton

- 2pcs 5.0Ah Li-ion battery
- 1pc charger
- Packaging: Color Box

DG-501

CORDLESS ANGLE GRINDER



6 pieces in one carton

- Tool-less adjustable guard allows for quick and convenient adjustments.
- Spindle lock enables fast and easy disc changes.
- 3-position handle provides flexibility and improved control.
- Safety trigger enhances operational safety and reduces accidental starts.
- Brushless motor delivers greater durability and extended tool life.

Pad Dia	5" / 125 (mm)
Spindle Size	M14 x P2.0
No Load Speed (RPM)	8000
Tool length	12-9/16"
Weight (bare tool)	2.2 (kg) / 4.8 (lbs)
Rating Voltage	18 (V)
Completely Charged	20 (V)
Battery	Li-ion 5.0 Ah



Note : The grinding wheel is not supplied along with the tool



DG-501A[KIT]

CORDLESS ANGLE GRINDER

2 pieces in one carton

- 2pcs 5.0Ah Li-ion battery
- 1pc charger

CORDLESS TOOLS

CORDLESS TOOLS

DG-585

CORDLESS ANGLE GRINDER

10 pieces in one carton

- Tool-less adjustable guard allows for quick and convenient adjustments.
- Spindle lock enables fast and easy disc changes.
- 2-position handle offers flexibility and enhanced control.
- Lock-on switch ensures continuous operation for prolonged tasks.

Pad Dia	5" / 125 (mm)
Spindle Size	M14 x P2.0
No Load Speed (RPM)	8000
Tool length	11-1/4"
Weight (bare tool)	2.2 (kg) / 4.8 (lbs)
Rating Voltage	18 (V)
Completely Charged	20 (V)
Battery	Li-ion 5.0 Ah



Note : The grinding wheel is not supplied along with the tool

DG-585502A[KIT]

CORDLESS ANGLE GRINDER

2 pieces in one carton

- 2pcs 5.0Ah Li-ion battery
- 1pc charger
- 1pc Guard spanner
- 1pc Aux handle



DCS-101

CORDLESS CIRCULAR SAW

2 pieces in one carton

- The heavy-duty aluminum base is engineered to be both lightweight and durable.
- Ergonomic design with soft-grip handles provides superior comfort and control.
- The electric brake ensures the blade stops quickly for enhanced safety.

Blade Arbor Size	16 (mm)
Blade Dia	7-1/4" / 185 (mm)
No Load Speed (RPM)	4500
Overall Length	13-3/8" / 340 (mm)
Bevel Capacity	0-56°
90° Cutting Capacity	2-3/8" / 60.5 (mm)
45° Cutting Capacity	1-3/4" / 46 (mm)
Weight (bare tool)	3.4 (kg) / 7.5 (lbs)
Rating Voltage	18 (V)
Completely Charged	20 (V)
Battery	Li-ion 5.0 Ah



DCS-101A[KIT]

CORDLESS CIRCULAR SAW

2 pieces in one carton

- 2pcs 5.0Ah Li-ion battery
- 1pc charger



DOS-501

CORDLESS RANDOM ORBITAL SANDER

2 pieces in one carton

- Variable speed control allows you to match speed to work piece and task at hand.
- Soft start feature ensures smooth and controlled operation.
- Soft-grip handle enhances comfort and control during use.
- Includes a 1-1/4" dust port and a 2-1/2" dust port adapter for efficient debris extraction from the work area.

Pad Dia	5" / 125 (mm)
No Load Speed (RPM)	7000-11000
Overall Length	11-13/16" / 300 (mm)
Weight (bare tool)	1.2 (kg) / 2.7 (lbs)
Orbit	3.0 (mm)
Rating Voltage	18 (V)
Completely Charged	20 (V)
Battery	Li-ion 5.0 Ah



DOS-501A[KIT]

CORDLESS RANDOM ORBITAL SANDER

2 pieces in one carton

- 2pcs 5.0Ah Li-ion battery
- 1pc charger
- Packaging: Color Box



DR-102 CORDLESS RIVET GUN



10 pieces in one carton

- Maximum pulling force of 20,000 Nm.
- Compatible with rivet diameters: Ø 2.4 mm, Ø 3.2 mm, Ø 4.0 mm, Ø 4.8 mm, and Ø 6.4 mm.
- Features a rivet holding mechanism to securely hold rivets in place, preventing them from dropping out even when the tool is pointed downward.

Traction Power	4496 (lb-f) / 2040 (kg-f)
Stroke Length	27 (mm)
Capacity	2.4-6.4 (mm)
Tool Length	320 (mm)
Weight (bare tool)	1.6 (kg) / 3.6 (lbs)
Rating Voltage	18 (V)
Completely Charged	20 (V)
Battery	Li-ion 5.0 Ah



DR-102A[KIT] CORDLESS RIVET GUN

3 pieces in one carton

- 2pcs 5.0Ah Li-ion battery
- 1pc charger

DGG-102 CORDLESS GREASE GUN

6 pieces in one carton

- The housing cap is compatible with DIN 1284 400g cartridges and Lube Shuttle 400g cartridges.
- Tool with a built-in relief valve, allowing overflow grease to flow back into the grease cartridge.
- Automatically prevents machine damage caused by overpressure.

Working Pressure	7000 (PSI)
Max Grease Output	94.6 (ml)
Capacity	400 (g)
Weight (bare tool)	2.4 (kg) / 5.3 (lbs)
Rating Voltage	18 (V)
Completely Charged	20 (V)
Battery	Li-ion 5.0 Ah



DGG-102A[KIT] CORDLESS GREASE GUN

3 pieces in one carton

- 2pcs 5.0Ah Li-ion battery
- 1pc charger

DHG-101 CORDLESS HEAT GUN

8 pieces in one carton

- Reaches operational temperature in just 10 seconds.
- Variable speed control allows you to match speed to work piece and task at hand.
- Lock-off feature prevents accidental startups, ensuring user safety.

Airflow	200 (L/min)
Max Temperature	550 (°c)
Weight (bare tool)	0.6 (kg) / 1.4 (lbs)
Rating Voltage	18 (V)
Completely Charged	20 (V)
Battery	Li-ion 5.0 Ah



DHG-101A[KIT] CORDLESS HEAT GUN

1 pieces in one carton

- 2pcs 5.0Ah Li-ion battery
- 1pc charger



CORDLESS TOOLS

DFL-101

CORDLESS LED FLOOD LIGHT

4 pieces in one carton

- Battery: 5.0Ah Li-ion
- Bulb Type: LED

Lumens	Runtime
180° 450 lm	18Hrs
360° - Low 550 lm	20Hrs
360° - High 850 lm	10Hrs



DWL-101

NEW

WORK LIGHT

2 pieces in one carton

- Battery: 5.0 Ah Li-ion
- Bulb Type: COB LED
- AC/DC Adaptor: 18V 2A
- Modes: Low / OFF / High / OFF
- Size: 250 x 140 x 300 mm
- Weight: 2400 g
- Waterproof Rating: IPX4

Max output lm and Run time	
Low mode	High mode
battery pack 1000 lm @ 6 hrs	battery pack 6000 lm @ 3 hrs
AC 900 lm	AC 3200 lm



DWL-102

NEW

WORK LIGHT

2 pieces in one carton

- Battery: 5.0 Ah Li-ion
- Bulb Type: White SMD & Warm SMD LED
- AC/DC Adaptor: 18V 2A
- Modes: Low / OFF / High / OFF
- Size: 180x145x440 mm
- Weight: 2850 g
- Waterproof Rating: IPX4

		Max output	Run time
battery pack	White	2000 lm / 7000 lm	7.5 Hrs / 2.5 Hrs
	Warm	2000 lm / 7000 lm	7.5 Hrs / 2.5 Hrs
AC	White	1000 lm / 3500 lm	---



DGS-101 NEW

CORDLESS BACKPACK SPRAYER

1 pieces in one carton

- Two-stage pressure adjustment function.
- Real-time stable atomization output ensures consistent performance.
- Carrying strap design provides lightweight and convenient usage.

Pressure	4.0 (bar) / 5.0 (bar)
Tank Capacity	12 (L)
Flow Rate	1.2 (L/min)
Weight (bare tool)	3.4 (kg) / 7.5 (lbs)
Rating Voltage	18 (V)
Completely Charged	20 (V)
Battery	Li-ion 5.0 Ah
Plastic Lance length	58 (cm)
Flexible Hose length	124 (cm)



a. 1.1 L/MIL



Ø 23 x 63 mm

b. 1.7 L/MIL

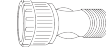

Ø 27 x 50 mm

c. 1.9 L/MIL



Ø 23 x 90 mm

d. 1.2 L/MIL



Ø 23 x 71 mm

e. 1.7 L/MIL



Ø 76.5 x 65 mm

DPW-101

CORDLESS PRESSURE WASHER GUN

4 pieces in one carton

- 4-in-1 Multi-Pattern Nozzle.
- Foam Cannon.
- 4m Low-Pressure Inlet Hose.
- Easy Twist Connection for lance and nozzle.
- 2-Step Power Mode.

Flow Rate	2.8 (L/min)
Hose Length	4 (m)
Maximum Pressure	360 (PSI) / 25 (bar)
Tool Length	876 (mm)
Weight (bare tool)	1.7 (kg) / 3.7 (lbs)
Rating Voltage	18 (V)
Completely Charged	20 (V)
Battery	Li-ion 5.0 Ah



DDWV-104[KIT] NEW

CORDLESS BRUSHLESS VACUUM CLEANER

1 pieces in one carton

- Automatic Stop When Full: Automatically halts operation when water reaches maximum capacity, protecting the motor.
- Switchable to Blowing Mode: Ideal for clearing debris from hard-to-reach areas.
- Extended Telescopic Hose: 3.2 meters for added reach and flexibility.
- Working Time: High Power: 20 minutes; Low Power: 35 minutes (Based on 5.0Ah battery pack).
- Shoulder Strap and Swivel Wheels: Enhances portability and ease of use.
- Capacity: Holds up to 10L of dry waste or 8L of wastewater.

Maximum Suction Power (Low Gear)	9 (kpa)
Maximum Suction Power (High Gear)	16 (kpa)
Capacity (Water)	8 (L)
Capacity (Dust)	10 (L)
Telescopic Pipe Length	3.2 (M)
Run time (Low Gear)	35 (min)
Run time (High Gear)	20 (min)
Weight (bare tool)	4.1 (kg) / 9.1 (lbs)
Rating voltage	18 (V)
Completely charged	20 (V)

DDWV-900F
HEPA filter



DDWV-901
4 Rotary wheels



DDWV-902
Big brush & 3 pcs plastic tubes



DDWV-903
Nozzle



DDWV-904
Soft tube



DDWV-905
Strap

GARDEN TOOLS

I DLB-102 **NEW**

CORDLESS LEAF BLOWER

2 pieces in one carton

- Two Air Ducts: Designed for easy installation and efficient airflow.
- Ergonomic Handle: Features a soft grip for enhanced comfort during use.
- Electronic Signal Switch: Provides easy and precise control.
- Versatile Applications: Suitable for lawn grooming, snow removal, and dust removal.

Air speed	45 (m/s)
Air capacity	460 (CFM)
Weight (bare tool)	2.6 (kg) / 5.7 (lbs)
Rating Voltage	18 (V)
Completely Charged	20 (V)
Battery	Li-ion 5.0 Ah



I DCCS-101 **NEW**

CORDLESS CHAIN SAW

2 pieces in one carton

- Mechatronic Safety Trigger.
- Tool-less Adjustment: Features a double-switch safety trigger and anti-self-locking switch.
- Rubber Sleeve Design: Reduce vibration during use.
- Brushless Motor: Offers greater efficiency, durability, and performance.
- Tool-Free Chain Adjustment: Allows for quick and easy chain adjustments.
- Automatic Chain Lubrication System: Ensures smoother and more efficient cutting while extending the tool's service life.

Guard Length	10" / 254 (mm)
Cut Size	7.87" / 200 (mm)
Weight (bare tool)	2.7 (kg) / 6.0 (lbs)
Rating Voltage	18 (V)
Completely Charged	20 (V)
Battery	Li-ion 5.0 Ah



I DHT-101 **NEW**

CORDLESS HEDGE TRIMMER TOOL

1 pieces in one carton

- Double-Switch Safety Trigger.
- Ergonomic design of the handle.
- Handle knob with 5 positions can be adjusted at any time to meet the user's needs.
- Maximum cutting diameter of the blade is 19 mm, blade length is 20".

No Load Speed (SPM)	1400
Blade Length	24" / 610 (mm)
Cutting Diameter	3/4" / 19 (mm)
The handle can be rotated	45° & 90°
Weight (bare tool)	2.6 (kg) / 5.7 (lbs)
Rating Voltage	18 (V)
Completely Charged	20 (V)
Battery	Li-ion 5.0 Ah



DST-101 **NEW**

CORDLESS STRING TRIMMERS

2 pieces in one carton

- 300mm cut path with 2mm dual-line bump feed.
- Adjustable Auxiliary Handle.
- Foldable pole for easier storage.

Cutting Width	300 (mm)
Line Advance System	Bump Feed
Cutting-line Type	2 (mm). Twisted nylon line
No Load Speed (RPM)	5800-7000
Weight (bare tool)	3.0 (kg) / 5.7 (lbs)
Tool length	876 (mm)
Rating Voltage	18 (V)
Completely Charged	20 (V)
Battery	Li-ion 5.0 Ah



DGM-101 **NEW**

CORDLESS GARDEN MULTI-HEAD TOOLS

1 pieces in one carton

- Multi-Function Quick-Change Head: Allows for versatile applications and easy tool adjustments.
- Double-Action Switch: Prevents accidental operation.
- Tool with Lifting Ring: Includes a shell installation strap for easier operation.

No Load Speed	7400 (RPM)
Cutting Brush Speed	6900 (RPM)
Grassing Speed	6900 (RPM)
High Branch Shear Speed	2400 (SPM)
Cutting Diameter	10 (mm)
Rating Voltage	36 (V): 2pcs 18V batteries
Completely Charged	40 (V): 2pcs 18V batteries
Battery	Li-ion 5.0 Ah



DGM-901
Pole saw head



DGM-902
Brush cutter head



DGM-903
Hedge trimmer head



DGM-904
String trimmer head

AIR IMPACT WRENCH



AIR IMPACT WRENCH

INC-3210

3/8" DRIVE Twin hammer type



10 pieces in one carton



INC-3231Q

3/8" DRIVE Twin hammer type



10 pieces in one carton



INC-3410

3/8" DRIVE Rocking dog type



20 pieces in one carton



INC-3610Q

3/8" DRIVE Jumbo hammer type



10 pieces in one carton



INC-3810

3/8" DRIVE Twin dog type



20 pieces in one carton



INC-3812

3/8" DRIVE Twin dog type



10 pieces in one carton



INC-3831

3/8" DRIVE Twin dog type



10 pieces in one carton



INC-398

3/8" DRIVE Jumbo hammer type



12 pieces in one carton

Extended handle design allows access to confined spaces.



Item No.	Square Drive		Torque Range	Max Torque		No Load Speed	Avg. Air Consumption	Air Pressure	Overall Length	Net Weight		Air Hose	Sound Pressure	Vibration Level	Air Inlet
	Inch	Inch (mm)		ft-lb (Nm)	ft-lb					Nm	R.P.M				
NC-3210	3/8"	1/2"(13)	100-300(136-407)	350	474	10000	4.0(113)	90(6.3)	5-5/8"(142)	3.3	1.5	3/8"	92.1	3.6	1/4"
NC-3231Q	3/8"	1/2"(13)	200-350(271-475)	450	610	8000	4.2(129)	90(6.3)	6-5/16"(160)	2.8	1.3	3/8"	83.0	3.0	1/4"
NC-3410	3/8"	3/8"(10)	5-50(7-68)	75	102	10000	2.5(71)	90(6.3)	6-1/4"(159)	1.7	0.8	3/8"	92.1	3.6	1/4"
NC-3610Q	3/8"	1/2"(13)	100-300(136-407)	350	474	8000	4.4(124)	90(6.3)	4-9/16"(115.5)	3.3	1.5	3/8"	85.0	2.8	1/4"
NC-3810	3/8"	3/8"(10)	5-50(7-67)	75	101	11000	2.3(65)	90(6.3)	5-15/32"(139)	1.1	0.5	3/8"	91.0	3.6	1/4"
NC-3812	3/8"	M10-M12	60-120(81-162)	180	244	8000	10(283)	90(6.3)	7-31/64"(190)	2.3	1.1	3/8"	97.0	5.1	1/4"
NC-3831	3/8"	5/32"(M12)	80-120(108-162)	180	244	8000	10(283)	90(6.3)	7-9/32"(185)	2.9	1.3	3/8"	93.0	4.9	1/4"
NC-398	3/8"	9/16"(14)	50-200(68-271)	300	407	6500	4.2(119)	90(6.3)	9-3/4"(247)	3.0	1.4	3/8"	85.0	2.0	1/4"

NE-399

3/8" DRIVE Jumbo hammer type



8 pieces in one carton

- Suitable for use in confined spaces.



NE-499

1/2" DRIVE Jumbo hammer type



8 pieces in one carton

- Suitable for use in confined spaces.



NE-499N

1/2" DRIVE Jumbo hammer type



8 pieces in one carton

- 1pc - Air Angle Impact Ratchet (NE-499)
- Stubby impact sockets, 6 points :
- 9pcs - 9, 10, 11, 13, 14, 17, 19, 22, 24 mm
- 1pc - 1/4" plug



RA-111

3/8" DRIVE Twin hammer type



10 pieces in one carton



NC-4117

1/2" DRIVE Pin clutch type



8 pieces in one carton

- PIN-CLUTCH low vibration impact structure, ideal for prolonged operation on assembly lines.



Composite material

2.0 KG
700 ft-lb
949 Nm

NC-4130

1/2" DRIVE Pin clutch type



10 pieces in one carton

- Low-vibration impact structure, ideal for prolonged operation on assembly lines.



1.2 m/s²
VIBRATION LOW

1.8 KG
800 ft-lb
813 Nm

NC-4217

1/2" DRIVE Twin hammer type



8 pieces in one carton



NC-4210

1/2" DRIVE Twin hammer type



10 pieces in one carton



NC-4210N

1/2" DRIVE Twin hammer type



4 pieces in one carton

- Stubby impact socket, 6 points:
- 5pcs 13, 17, 19, 22, 24 mm



NC-4213

1/2" DRIVE Twin hammer type



10 pieces in one carton



NC-4223

1/2" DRIVE Twin hammer type



4 pieces in one carton

- NC-4223 is equipped
- with 2" extended anvil



Item No.	Square Drive		Torque Range	Max Torque		No Load Speed	Avg. Air Consumption	Air Pressure	Overall Length	Net Weight		Air Hose	Sound Pressure	Vibration Level	Air Inlet
	Inch	Inch (mm)		ft-lb (Nm)	ft-lb					Nm	R.P.M				
NE-399	3/8"	3/8"(13)	50-130(68-176)	180	244	7500	2.45(69.4)	90(6.3)	13-3/8"(340)	4.0	1.8	3/8"	93.0	9.9	1/4"
NE-499	1/2"	9/16"(14)	50-130(68-203)	250	339	7500	2.45(69.4)	90(6.3)	13-3/8"(340)	4.0	1.8	3/8"	93.0	9.9	1/4"
RA-111	3/8"	5/16"(8)	3.7-36.9(5-50)	50	68	8500	8.5(255)	90(6.3)	8-1/4"(208)	2.2	1.0	3/8"	96.7	4.9	1/4"
NC-4117	1/2"	3/4"(18)	200-550(271-746)	700	949	7000	5.4(153)	90(6.3)	8"(205)	4.3	2.0	3/8"	90.0	2.5	1/4"
NC-4130	1/2"	5/8"(16)	180-400(244-542)	600	813	9000	4.5(127)	90(6.3)	5-9/16"(142)	3.6	1.6	3/8"	85.0	1.2	1/4"
NC-4210	1/2"	5/8"(16)	150-350(203-475)	400	542	10000	4.2(119)	90(6.3)	5-5/8"(142)	3.5	1.6	3/8"	90.6	2.8	1/4"
NC-4210N	1/2"	5/8"(16)	150-350(203-475)	400	542	10000	4.2(119)	90(6.3)	5-5/8"(142)	3.5	1.6	3/8"	90.6	2.8	1/4"
NC-4213	1/2"	5/8"(16)	180-400(244-542)	600	813	6500	4.2(119)	90(6.3)	7-3/16"(182)	6.2	2.8	3/8"	91.0	3.8	1/4"
NC-4223	1/2"	5/8"(16)	180-400(244-542)	600	813	6500	4.2(119)	90(6.3)	9-1/4"(232)	6.4	2.9	3/8"	91.0	3.8	1/4"
NC-4217	1/2"	5/8"(16)	150-320(203-434)	400	542	7000	4.2(119)	90(6.3)	7-1/4"(184)	5.6	2.5	3/8"	92.1	3.7	1/4"

AIR IMPACT WRENCH

AIR IMPACT WRENCH



NC-4230

1/2" DRIVE Twin hammer type



8 pieces in one carton

- Suitable for long-term, high-intensity industrial assembly.



NC-4230Q

1/2" DRIVE Twin hammer type



8 pieces in one carton

- Suitable for long-term, high-intensity industrial assembly.



NC-4240

1/2" DRIVE Twin hammer type



8 pieces in one carton

- NC-4240 is equipped with 2" extended anvil



NC-4232Q

1/2" DRIVE Twin hammer type



10 pieces in one carton

Composite material



NC-4233Q

1/2" DRIVE Twin hammer type



8 pieces in one carton

Composite material



NC-4233QH

1/2" DRIVE Twin hammer type



8 pieces in one carton

- EZ GREASE ANVIL
- For EZ grease version only



Composite material

NC-4233TL

1/2" DRIVE Twin hammer type



8 pieces in one carton

Composite material



NC-4236

1/2" DRIVE Twin hammer type



8 pieces in one carton

- Forward operation torque is limited 50-80 Nm for vehicle tire service.
- 6 rotor-blades makes efficient starting torque.



Item No.	Square Drive		Torque Range	Max Torque		No Load Speed	Avg. Air Consumption	Air Pressure	Overall Length	Net Weight		Air Hose	Sound Pressure	Vibration Level	Air Inlet
	Inch	Inch (mm)		ft-lb (Nm)	ft-lb					Nm	R.P.M				
NC-4230	1/2"	3/4"(19)	180-500(244-678)	700	949	7500	4.5(127)	90(6.3)	6-15/32"(164)	5.5	2.5	3/8"	87.0	4.5	1/4"
NC-4230Q	1/2"	3/4"(19)	180-500(244-678)	650	881	6500	4.5(127)	90(6.3)	6-15/32"(164)	5.5	2.5	3/8"	85.0	4.5	1/4"
NC-4240	1/2"	3/4"(19)	180-500(244-678)	700	949	7500	4.5(127)	90(6.3)	8-15/32"(215)	5.7	2.6	3/8"	87.0	4.5	1/4"
NC-4232Q	1/2"	5/8"(16)	100-400(136-542)	550	746	10000	4.0(113)	90(6.3)	4-3/4"(120)	3.0	1.4	3/8"	83.0	3.7	1/4"
NC-4233Q	1/2"	3/4"(19)	200-500(271-678)	850	1152	9000	4.6(132)	90(6.3)	7-1/2"(190)	4.6	2.1	3/8"	85.0	4.4	1/4"
NC-4233QH	1/2"	3/4"(19)	200-500(271-678)	850	1152	9000	4.6(132)	90(6.3)	7-1/2"(190)	4.6	2.1	3/8"	85.0	4.4	1/4"
NC-4233TL	1/2"	3/4"(19)	37-59(50-80)	850	1152	2800	4.6(132)	90(6.3)	7-1/2"(190)	4.6	2.1	3/8"	85.0	4.4	1/4"
NC-4236	1/2"	1"(25)	200-700(271-949)	1000	1356	7500	5.5(155)	90(6.3)	6-45/64"(171)	5.7	2.6	3/8"	87.0	4.5	1/4"



NC-4236Q

1/2" DRIVE Twin hammer type



8 pieces in one carton



NC-4256

1/2" DRIVE Twin hammer type



10 pieces in one carton



NC-4256Q

1/2" DRIVE Twin hammer type



10 pieces in one carton



NC-4256Q-2

1/2" DRIVE Twin hammer type



10 pieces in one carton



NC-4255Q^{TOP}

1/2" DRIVE Twin hammer type



8 pieces in one carton



NC-4255QH

EZ grease anvil

- EZ GREASE ANVIL
- For EZ grease version only



NC-4255QP

With protective cover inside

NC-4255PVC

Protective cover

- The NC-4255PVC protective boot can apply on NC-4255Q & NC-6255Q



NC-4265Q

1/2" DRIVE Twin hammer type



8 pieces in one carton



Item No.	Square Drive		Torque Range	Max Torque		No Load Speed	Avg. Air Consumption	Air Pressure	Overall Length	Net Weight		Air Hose	Sound Pressure	Vibration Level	Air Inlet
	Inch	Inch (mm)		ft-lb	Nm					R.P.M	CFM (L/min)				
NC-4236Q	1/2"	1"(25)	200-700(271-949)	1000	1356	7500	5.5(155)	90(6.3)	6-45/64"(171)	5.7	2.6	3/8"	83.0	4.5	1/4"
NC-4256	1/2"	1"(25)	200-900(271-1220)	1100	1491	9000	5.1(144)	90(6.3)	5-9/16"(141)	4.0	1.8	3/8"	95.0	2.8	1/4"
NC-4256Q	1/2"	1"(25)	200-900(271-1220)	1000	1356	7000	5.1(144)	90(6.3)	5-9/16"(141)	4.0	1.8	3/8"	85.0	2.8	1/4"
NC-4256Q-2	1/2"	1"(25)	200-900(271-1220)	1000	1356	7000	5.1(144)	90(6.3)	7-9/16"(191)	4.2	1.9	3/8"	85.0	2.8	1/4"
NC-4255Q	1/2"	1"(25)	200-800(271-1085)	1200	1627	8500	4.8(136)	90(6.3)	7-1/32"(179)	3.7	1.7	3/8"	85.0	4.7	1/4"
NC-4255QP	1/2"	1"(25)	200-800(271-1085)	1200	1627	8500	4.8(136)	90(6.3)	7-1/32"(179)	4.0	1.8	3/8"	85.0	4.7	1/4"
NC-4255QH	1/2"	1"(25)	200-800(271-1085)	1200	1627	8500	4.8(136)	90(6.3)	7-1/32"(179)	3.7	1.7	3/8"	85.0	4.7	1/4"
NC-4265Q	1/2"	1"(25)	200-800(271-1085)	1200	1627	8500	4.8(136)	90(6.3)	9-1/32"(230.5)	3.9	1.8	3/8"	85.0	4.7	1/4"

AIR IMPACT WRENCH

AIR IMPACT WRENCH



NC-4258

1/2" DRIVE Twin hammer type



8 pieces in one carton

- Durable and robust with impact resistance.



NC-4277Q

1/2" DRIVE Twin hammer type



10 pieces in one carton

- Single-handed forward/reverse switch operation.



High cost-performance ratio.

NC-4299Q

1/2" DRIVE Twin hammer type



10 pieces in one carton

- Ideal for general automotive repair shops.



High cost-performance ratio.

NC-4600

1/2" DRIVE Jumbo hammer type



10 pieces in one carton

- Replaceable anvil design.



NC-4610

1/2" DRIVE Jumbo hammer type



10 pieces in one carton

- World's first mini impact wrench.



NC-4610Q

1/2" DRIVE Jumbo hammer type



10 pieces in one carton



NC-4610N

1/2" DRIVE Jumbo hammer type



4 pieces in one carton

- Stubby impact socket, 6 points:
- 5pcs 13, 17, 19, 22, 24 mm



NC-4630

1/2" DRIVE Jumbo hammer type



10 pieces in one carton



Item No.	Square Drive		Torque Range	Max Torque		No Load Speed	Avg. Air Consumption	Air Pressure	Overall Length	Net Weight		Air Hose	Sound Pressure	Vibration Level	Air Inlet
	Inch	Inch (mm)		ft-lb (Nm)	ft-lb					Nm	R.P.M				
NC-4258	1/2"	5/8"(16)	150-300(203-407)	400	542	7000	4.2(119)	90(6.3)	7-1/4"(185)	5.6	2.5	3/8"	93.0	4.4	1/4"
NC-4277Q	1/2"	1"(25)	200-800(271-1088)	1150	1564	7000	4.8(136)	90(6.3)	6"(155)	4.4	2.0	3/8"	85.0	4.5	1/4"
NC-4299Q	1/2"	3/4"(19)	150-500(204-680)	800	1088	8500	4.0(113)	90(6.3)	7-1/2"(194)	4.6	2.1	3/8"	85.0	3.2	1/4"
NC-4600	1/2"	5/8"(16)	180-500(244-678)	600	813	9000	4.2(119)	90(6.3)	4"(99)	3.0	1.4	3/8"	96.0	3.7	1/4"
NC-4610	1/2"	5/8"(16)	200-350(271-475)	450	610	9000	4.4(124)	90(6.3)	4-9/16"(115.5)	3.5	1.6	3/8"	93.0	2.8	1/4"
NC-4610Q	1/2"	5/8"(16)	200-350(271-475)	400	542	9000	4.4(124)	90(6.3)	4-9/16"(115.5)	3.5	1.6	3/8"	85.0	2.8	1/4"
NC-4610N	1/2"	5/8"(16)	200-350(271-475)	450	610	9000	4.4(124)	90(6.3)	4-9/16"(115.5)	3.5	1.6	3/8"	93.0	2.8	1/4"
NC-4630	1/2"	5/8"(16)	100-400(136-542)	450	610	9000	4.4(124)	90(6.3)	3-27/32"(97)	3.3	1.5	3/8"	96.0	2.8	1/4"



NC-4630Q

1/2" DRIVE Jumbo hammer type



10 pieces in one carton



NC-4650 ^{TOP}

1/2" DRIVE Jumbo hammer type



10 pieces in one carton



104 Mini mm

850 ft-lb
900 Nm

NC-4650H

1/2" DRIVE Jumbo hammer type



10 pieces in one carton

- EZ GREASE ANVIL
- For EZ grease version only

Patent grease hole



NC-4670Q

1/2" DRIVE Jumbo hammer type



8 pieces in one carton



Composite material

SIDE TO SIDE
1.1 KG
850 ft-lb
900 Nm

NC-4811

1/2" DRIVE Twin dog type



10 pieces in one carton



NC-488 ^{NEW}

1/2" DRIVE Jumbo hammer type



8 pieces in one carton

- Toolless: Fast and easy, select the desired angle by bare hands.
- No loosening worry: Intelligent chaining design ensures the chosen angle is fixed and secured.



The Adjustable Head with Angle Lock 160°- The widest adjusting angle in the market.

NC-498

1/2" DRIVE Jumbo hammer type



12 pieces in one carton

- Extended handle design allows access to confined spaces.



400 ft-lb
542 Nm

Item No.	Square Drive	Bolt Capacity	Torque Range	Max Torque		No Load Speed	Avg. Air Consumption	Air Pressure	Overall Length	Net Weight		Air Hose	Sound Pressure	Vibration Level	Air Inlet
	Inch	Inch (mm)	ft-lb (Nm)	ft-lb	Nm	R.P.M	CFM (L/min)	PSI (bar)	Inch (mm)	LBS	kg	Inch	dBA	m/s ²	Inch
NC-4630Q	1/2"	5/8"(16)	200-350(271-475)	450	610	9000	4.4(124)	90(6.3)	3-27/32"(97)	3.3	1.5	3/8"	85.0	2.8	1/4"
NC-4650	1/2"	5/8"(16)	180-400(244-542)	650	900	9000	4.69(132.8)	90(6.3)	4-1/16"(104)	3.3	1.4	3/8"	95.0	2.4	1/4"
NC-4650H	1/2"	5/8"(16)	180-400(244-542)	650	900	9000	4.69(132.8)	90(6.3)	4-1/16"(104)	3.3	1.4	3/8"	95.0	2.4	1/4"
NC-4670Q	1/2"	5/8"(16)	150-500(204-680)	650	884	9000	5.2(147)	90(6.3)	4"(105)	2.4	1.1	3/8"	85.0	3.3	1/4"
NC-4811	1/2"	9/16"(14)	118-140(160-189)	210	285	5500	8.5(240)	90(6.3)	10-9/32"(260)	3.7	1.7	3/8"	85.0	5.3	1/4"
NC-488	1/2"	5/8"(16)	100-450(136-610)	500	678	9000	5.0(142)	90(6.3)	11-1/4"(284)	3.7	1.7	3/8"	93.0	4.3	1/4"
NC-498	1/2"	5/8"(16)	80-300(108-407)	400	542	6500	4.2(119)	90(6.3)	9-3/4"(247)	3.0	1.4	3/8"	85.0	2.0	1/4"

AIR IMPACT WRENCH

AIR IMPACT WRENCH

NC-6113

3/4" DRIVE Pin clutch type



4 pieces in one carton



NC-6123

3/4" DRIVE Pin clutch type



4 pieces in one carton



NC-6201

3/4" DRIVE Twin hammer type



6 pieces in one carton



NC-6210Q

3/4" DRIVE Twin hammer type



8 pieces in one carton



NC-6215

3/4" DRIVE Twin hammer type



4 pieces in one carton



NC-6216

3/4" DRIVE New twin hammer type



4 pieces in one carton



NC-6216PVC

Protective cover



NC-6217

3/4" DRIVE Twin hammer type



4 pieces in one carton



NC-6225

3/4" DRIVE Twin hammer type



4 pieces in one carton

NC-6225 is equipped with 6" extended anvil



NC-6226

3/4" DRIVE New twin hammer type



4 pieces in one carton

NC-6226 is equipped with 6" extended anvil



NC-6218

3/4" DRIVE Twin hammer type



2 pieces in one carton



NC-6218-6

3/4" DRIVE Twin hammer type



2 pieces in one carton

NC-6218-6 is equipped with 6" extended anvil



Item No.	Square Drive	Bolt Capacity	Torque Range	Max Torque	No Load Speed	Avg. Air Consumption	Air Pressure	Overall Length	Net Weight	Air Hose	Sound Pressure	Vibration Level	Air Inlet
	Inch	Inch (mm)	ft-lb (Nm)	ft-lb Nm	R.P.M	CFM (L/min)	PSI (bar)	Inch (mm)	LBS kg	Inch	dBA	m/s ²	Inch
NC-6113	3/4"	1"(25)	150-600(203-814)	850 1153	4500	7.0(198)	90(6.3)	10"(252)	10.1 4.6	1/2"	94.3	7.2	1/4"
NC-6123	3/4"	1"(25)	150-600(203-814)	850 1153	4500	7.0(198)	90(6.3)	14-3/16"(360)	11.6 5.3	1/2"	94.3	7.2	1/4"
NC-6201	3/4"	1-3/16"(30)	200-1200(271-1627)	1450 1966	5700	6.4(181)	90(6.3)	8-3/4"(222)	8.1 3.7	1/2"	88.0	5.9	3/8"
NC-6210Q	3/4"	3/4"(19)	180-600(244-810)	700 949	6500	4.5(127)	90(6.3)	6-45/64"(170)	5.6 2.6	3/8"	85.0	4.5	3/8"
NC-6215	3/4"	1"(25)	180-600(244-810)	900 1220	6500	7.0(198)	90(6.3)	9-7/32"(234)	10.0 4.5	1/2"	91.5	10.8	1/4"
NC-6225	3/4"	1"(25)	180-600(244-810)	900 1220	6500	7.0(198)	90(6.3)	13-3/4"(350)	10.8 4.9	1/2"	91.5	10.8	1/4"
NC-6216	3/4"	1-1/16"(27)	200-1000(271-1356)	1200 1627	6000	6.0(170)	90(6.3)	9-1/4"(235)	9.0 4.1	1/2"	91.2	5.0	3/8"
NC-6226	3/4"	1-1/16"(27)	200-1000(271-1356)	1200 1627	6000	6.0(170)	90(6.3)	13-3/4"(350)	9.9 4.5	1/2"	91.2	5.0	3/8"
NC-6217	3/4"	1-1/4"(30)	200-1300(271-1762)	1400 1898	4800	5.4(153)	90(6.3)	8-15/32"(215)	11.0 5.0	1/2"	92.0	6.1	3/8"
NC-6218	3/4"	1-1/16"(27)	200-1400(271-1898)	1500 2034	6000	6.3(182)	90(6.3)	12-9/16"(320)	12.5 5.7	1/2"	106.0	3.3	3/8"
NC-6218-6	3/4"	1-1/16"(27)	200-1400(271-1898)	1500 2034	6000	6.3(182)	90(6.3)	18-1/2"(470)	6.1 13.4	1/2"	106.0	3.3	3/8"

NC-6233Q

3/4" DRIVE Twin hammer type



6 pieces in one carton



High cost-performance ratio.

NC-6236

3/4" DRIVE Twin hammer type



8 pieces in one carton



NC-6236Q

3/4" DRIVE Twin hammer type



8 pieces in one carton



NC-6255Q

3/4" DRIVE Twin hammer type



8 pieces in one carton



High cost-performance ratio.

NC-6255QH

3/4" DRIVE Twin hammer type



8 pieces in one carton

Patent grease hole
For EZ grease version only



NC-6256Q

3/4" DRIVE Twin hammer type



6 pieces in one carton



NC-6266

3/4" DRIVE Twin hammer type



4 pieces in one carton

Authentic standard 3/4" model.



High cost-performance ratio.

NC-6266-6

3/4" DRIVE Twin hammer type



4 pieces in one carton

NC-6266-6 is equipped with 6" extended anvil



NC-6266H

3/4" DRIVE Twin hammer type



6 pieces in one carton

Patent grease hole
For EZ grease version only



NC-6610Q NEW

3/4" DRIVE Jumbo hammer type



10 pieces in one carton



Item No.	Square Drive		Torque Range	Max Torque		No Load Speed	Avg. Air Consumption	Air Pressure	Overall Length	Net Weight		Air Hose	Sound Pressure	Vibration Level	Air Inlet
	Inch	Inch (mm)		ft-lb (Nm)	ft-lb					Nm	R.P.M				
NC-6233Q	3/4"	15/16"(24)	150-1000(204-1360)	1300	1768	8500	4.6(130)	90(6.3)	7-3/4"(199)	5.1	2.3	3/8"	85.0	4.8	1/4"
NC-6236	3/4"	1"(25)	200-900(271-1220)	1200	1627	7500	5.5(155)	90(6.3)	6-45/64"(171)	5.9	2.7	3/8"	87.0	4.5	1/4"
NC-6236Q	3/4"	1"(25)	200-900(271-1220)	1200	1627	7500	5.5(155)	90(6.3)	6-45/64"(171)	5.9	2.7	3/8"	83.0	4.5	1/4"
NC-6255Q	3/4"	1"(25)	200-1100(271-1491)	1400	1898	8500	4.8(136)	90(6.3)	7-13/16"(198)	4.2	1.9	3/8"	85.0	4.7	1/4"
NC-6255QH	3/4"	1"(25)	200-1100(271-1491)	1400	1898	8500	4.8(136)	90(6.3)	7-13/16"(198)	4.2	1.9	3/8"	85.0	4.7	1/4"
NC-6256Q	3/4"	7/8"(23)	150-900(271-1220)	1200	1627	7000	5.1(144)	90(6.3)	5-11/16"(145)	4.2	1.9	3/8"	85.0	2.8	1/4"
NC-6266	3/4"	1-1/4"(30)	200-1300(271-1760)	1500	2034	6000	5.9(169)	90(6.3)	8-1/16"(205)	6.5	3.0	1/2"	88.0	5.9	3/8"
NC-6266-6	3/4"	1-1/4"(30)	200-1300(271-1760)	1500	2034	6000	5.9(167)	90(6.3)	14-9/16"(370)	7.9	3.6	3/8"	88.0	5.9	3/8"
NC-6266H	3/4"	1-1/4"(30)	200-1600(271-1760)	1500	2034	6000	5.9(169)	90(6.3)	8-1/16"(205)	6.5	3.0	1/2"	88.0	5.9	3/8"
NC-6610Q	3/4"	1-1/8"(27)	150-900(203-1220)	1300	1762	7000	5.1(144)	90(6.3)	5-7/16"(138)	4.0	1.8	3/8"	85.0	3.1	1/4"

AIR IMPACT WRENCH

AIR IMPACT WRENCH

NC-8211

1" DRIVE Twin hammer type



1 pieces in one carton



NC-8212

1" DRIVE Twin hammer type



4 pieces in one carton



NC-8216

1" DRIVE Twin hammer type



2 pieces in one carton



NC-8217

1" DRIVE Twin hammer type



4 pieces in one carton



NC-8221

1" DRIVE Twin hammer type



1 pieces in one carton

NC-8221 is equipped with 6" extended anvil



NC-8219

1" DRIVE New twin hammer type



2 pieces in one carton



NC-8226

1" DRIVE Twin hammer type



2 pieces in one carton

NC-8226 is equipped with 6" extended anvil



NC-8226Q

1" DRIVE Twin hammer type



2 pieces in one carton



NC-8232

1" DRIVE New twin hammer type



1 pieces in one carton



NC-8237

1" DRIVE Twin hammer type



4 pieces in one carton

Ideal for prolonged use on assembly lines.



NC-8237-6

1" DRIVE Twin hammer type



4 pieces in one carton

NC-8237-6 is equipped with 6" extended anvil



NC-8242

1" DRIVE Twin hammer type



2 pieces in one carton



Item No.	Square Drive	Bolt Capacity	Torque Range	Max Torque		No Load Speed	Avg. Air Consumption	Air Pressure	Overall Length	Net Weight		Air Hose	Sound Pressure	Vibration Level	Air Inlet
	Inch	Inch (mm)	ft-lb (Nm)	ft-lb	Nm	R.P.M	CFM (L/min)	PSI (bar)	Inch (mm)	LBS	kg	Inch	dBA	m/s ²	Inch
NC-8211	1"	1-3/8"(33)	200-1600(271-2170)	1800	2441	5000	10.0(284)	90(6.3)	14-9/16"(370)	22.2	10.1	1/2"	100	10.0	1/2"
NC-8212	1"	1-1/16"(27)	200-1000(271-1356)	1300	1762	6000	6.0(170)	90(6.3)	9-1/4"(235)	9.6	4.4	1/2"	91.2	5.0	3/8"
NC-8216	1"	1-3/8"(33)	200-1600(271-2170)	1800	2441	6000	9.0(254)	90(6.3)	13-1/2"(343)	15.5	7.0	1/2"	102	9.3	1/2"
NC-8217	1"	1-1/4"(30)	200-1300(271-1762)	1500	2034	4800	5.4(153)	90(6.3)	8-3/4"(222)	11.0	5.0	1/2"	92.0	6.1	3/8"
NC-8219	1"	1-7/16"(36)	200-1600(271-2170)	1800	2441	4000	11.0(311)	90(6.3)	12-13/32"(315)	21.6	9.8	1/2"	103.4	16.7	1/2"
NC-8221	1"	1-3/8"(33)	200-1600(271-2170)	1800	2441	5000	10.0(284)	90(6.3)	20-7/8"(530)	25.2	11.5	1/2"	100	10.0	1/2"
NC-8226	1"	1-3/8"(33)	200-1600(271-2170)	1800	2441	6000	9.0(254)	90(6.3)	19-3/16"(487)	18.4	8.4	1/2"	102	9.3	1/2"
NC-8226Q	1"	1-3/8"(33)	200-1600(271-2170)	1800	2441	6000	9.0(254)	90(6.3)	19-3/16"(487)	18.4	8.4	1/2"	90	9.3	1/2"
NC-8232	1"	1-7/16"(36)	200-1600(271-2170)	1800	2441	4000	11.0(311)	90(6.3)	20-13/32"(518)	24.8	11.3	1/2"	102	11.5	1/2"
NC-8237	1"	1-3/8"(33)	200-1500(271-2034)	1800	2441	4500	5.4(153)	90(6.3)	8-3/4"(222)	12.8	5.7	1/2"	92.0	6.1	3/8"
NC-8237-6	1"	1-3/8"(33)	200-1500(271-2034)	1800	2441	4500	5.4(153)	90(6.3)	15-9/16"(395)	14.3	6.5	1/2"	92.0	6.1	3/8"
NC-8242	1"	1-9/16"(40)	200-2000(271-2710)	2500	3390	5000	15.9(450)	90(6.3)	14-17/32"(370)	23.1	10.5	1/2"	100.0	6.4	1/2"

NC-8252

1" DRIVE Twin hammer type

★★

1 pieces in one carton



NC-8262

1" DRIVE Twin hammer type

★★

1 pieces in one carton

· NC-8262 is equipped with 6" extended anvil



NC-8260

1" DRIVE Twin hammer type

★★

6 pieces in one carton

Composite material
3.1 KG



NC-8260-6

1" DRIVE Twin hammer type

★★

6 pieces in one carton

· NC-8260-6 is equipped with 6" extended anvil

Composite material



NC-8242-8

1" DRIVE Twin hammer type

★★

1 pieces in one carton

· NC-8242-8 is equipped with 8" extended anvil



NC-8266P

1" DRIVE Twin hammer type

★★

2 pieces in one carton

Composite material
5.9 KG
2300 ft-lb
3118 Nm



NC-8266P-6

1" DRIVE Twin hammer type

★★

2 pieces in one carton

· NC-8266P-6 is equipped with 6" extended anvil

Composite material



NC-8266S

1" DRIVE Twin hammer type

★★

2 pieces in one carton

Composite material
6.0 KG
2300 ft-lb
3118 Nm



NC-8266S-6

1" DRIVE Twin hammer type

★★

2 pieces in one carton

· NC-8266S-6 is equipped with 6" extended anvil

Composite material



NC-8266S-8

1" DRIVE Twin hammer type

★★

2 pieces in one carton

· NC-8266S-8 is equipped with 8" extended anvil

Composite material



NC-8311

1" DRIVE Pin less type

★★

2 pieces in one carton

Composite material
7.6 KG
2000 ft-lb
2711 Nm

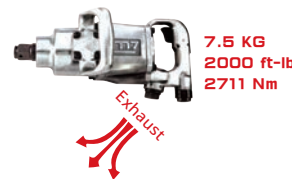

NC-8351

1" DRIVE Pin less type

★★

2 pieces in one carton

· NC-8351 is equipped with 6" extended anvil

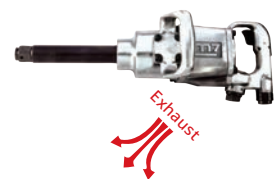

Item No.	Square Drive	Bolt Capacity	Torque Range	Max Torque	No Load Speed	Avg. Air Consumption	Air Pressure	Overall Length	Net Weight	Air Hose	Sound Pressure	Vibration Level	Air Inlet
	Inch	Inch (mm)	ft-lb (Nm)	ft-lb Nm	R.P.M.	CFM (L/min)	PSI (bar)	Inch (mm)	LBS kg	Inch	dBA	m/s ²	Inch
NC-8242-8	1"	1-9/16"(40)	200-2000(271-2710)	2500 3390	5000	15.9(450)	90(6.3)	22-15/32"(570)	26.2 11.9	1/2"	100.0	6.4	1/2"
NC-8252	1"	1-7/16"(36)	200-2000(271-2710)	2400 3250	4000	10.0(284)	90(6.3)	15-3/8"(390)	26.6 12.1	1/2"	100.0	10.0	1/2"
NC-8262	1"	1-7/16"(36)	200-2000(271-2710)	2400 3250	3700	11.0(284)	90(6.3)	17-7/8"(155)	35.2 16.0	1/2"	93.9	8.8	1/2"
NC-8260	1"	1-1/4"(32)	200-1600(271-2169)	1750 2372	6000	7.5(212)	90(6.3)	8-1/2"(218)	6.8 3.1	1/2"	87.0	5.9	3/8"
NC-8260-6	1"	1-1/4"(32)	200-1600(271-2169)	1750 2372	6000	7.5(212)	90(6.3)	14"(355)	9.0 4.1	1/2"	87.0	5.9	3/8"
NC-8266P	1"	1-3/8"(35)	200-2000(271-2711)	2300 3118	4500	9.0(255)	90(6.3)	10"(256)	13.0 5.9	1/2"	92.0	6.1	1/2"
NC-8266P-6	1"	1-3/8"(35)	200-2000(271-2711)	2300 3118	4500	9.0(255)	90(6.3)	16"(408)	13.9 6.3	1/2"	92.0	6.1	1/2"
NC-8266S	1"	1-3/8"(35)	200-1800(271-2440)	2300 3118	4500	7.5(212)	90(6.3)	16-7/8"(430)	13.2 6.0	1/2"	92	6.1	1/2"
NC-8266S-6	1"	1-3/8"(35)	200-1800(271-2440)	2300 3118	4500	7.5(212)	90(6.3)	22-3/4"(580)	15.8 7.3	1/2"	92	6.1	1/2"
NC-8266S-8	1"	1-3/8"(35)	200-1800(271-2440)	2300 3118	4500	7.5(212)	90(6.3)	24-3/4"(630)	16.3 7.4	1/2"	92	6.1	1/2"
NC-8311	1"	1-3/8"(33)	200-1600(271-2170)	1800 2441	4000	11.5(325)	90(6.3)	15"(380)	24.0 10.9	1/2"	101	7.3	1/2"
NC-8351	1"	1-3/8"(33)	200-1600(271-2170)	1800 2441	4000	11.5(325)	90(6.3)	20"(510)	27.6 12.6	1/2"	101	7.3	1/2"

AIR IMPACT WRENCH

AIR IMPACT WRENCH

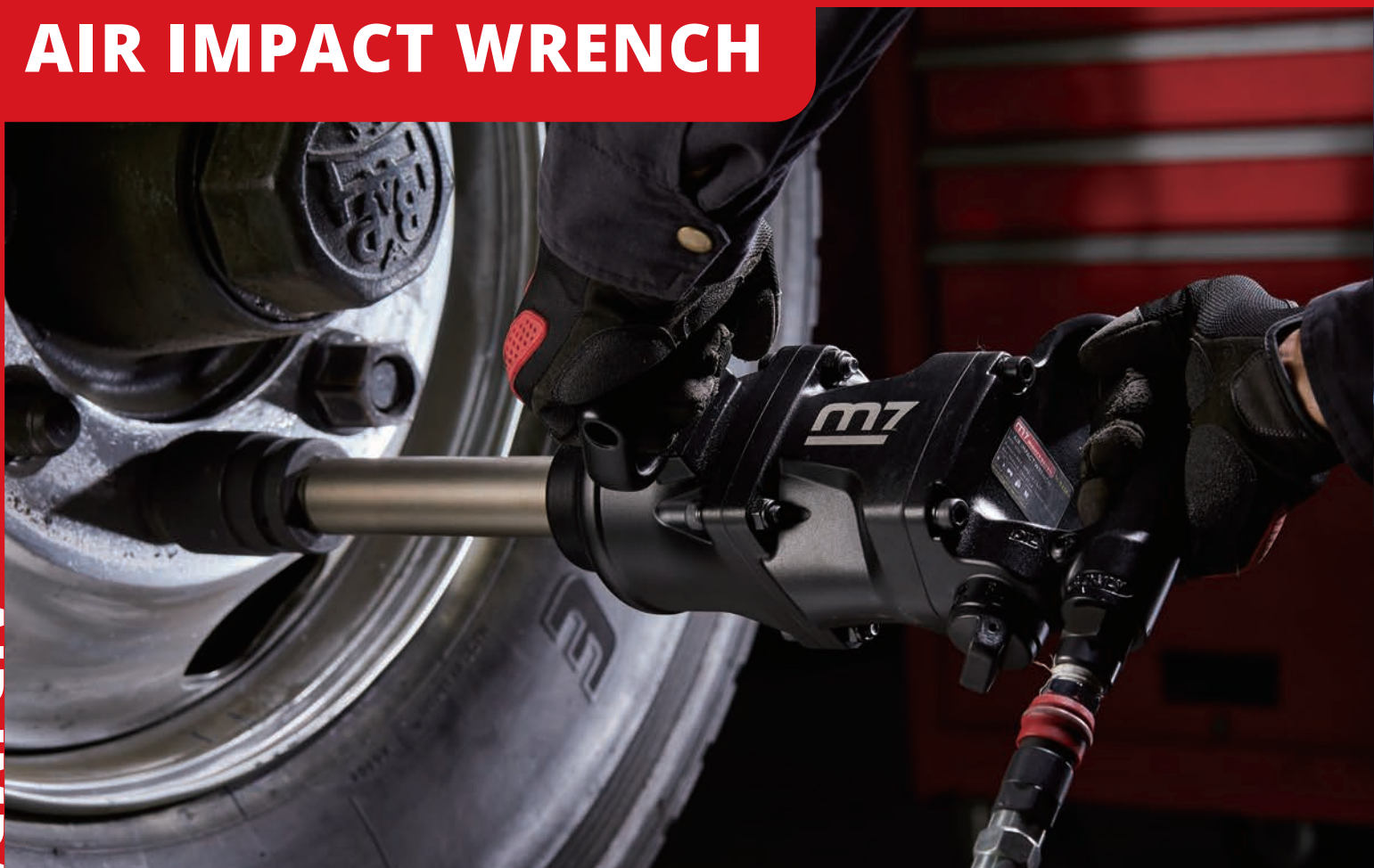

NC-8322

1" DRIVE Pin less type



1 pieces in one carton



Exhaust



NC-8342

1" DRIVE Pin less type



1 pieces in one carton

- NC-8342 is equipped with 8" extended anvil



Exhaust



NC-8331

1" DRIVE Pin less type



2 pieces in one carton



Exhaust



High cost-performance ratio.

NC-8331-6

1" DRIVE Pin less type



2 pieces in one carton

- NC-8331-6 is equipped with 6" extended anvil



Exhaust



NC-8332X

1" DRIVE Pin less type



2 pieces in one carton



Exhaust



NC-8332X-6

1" DRIVE Pin less type



2 pieces in one carton

- NC-8332X-6 is equipped with 6" extended anvil



Exhaust



NC-8343 TOP

1" DRIVE Pin less type



1 pieces in one carton



Exhaust



High cost-performance ratio.

NC-8343-8

1" DRIVE Pin less type



1 pieces in one carton

- NC-8343-8 is equipped with 8" extended anvil



Exhaust





NC-8362

1" DRIVE Pin less type



1 pieces in one carton



Exhaust



NC-8372

1" DRIVE Pin less type



1 pieces in one carton

- NC-8372 is equipped with 6" extended anvil



Exhaust



NC-8382

1" DRIVE Pin less type



2 pieces in one carton



Exhaust



NC-8382-8

1" DRIVE Pin less type



1 pieces in one carton

- NC-8382-8 is equipped with 8" extended anvil



Exhaust



NC-9223

1-1/2" DRIVE New twin hammer type



1 pieces in one carton



Exhaust



NC-9243

1-1/2" DRIVE New twin hammer type



1 pieces in one carton

- NC-9243 is equipped with 8" extended anvil



Exhaust



Item No.	Square Drive		Torque Range	Max Torque		No Load Speed	Avg. Air Consumption	Air Pressure	Overall Length	Net Weight		Air Hose	Sound Pressure	Vibration Level	Air Inlet
	Inch	Inch (mm)		ft-lb (Nm)	ft-lb					Nm	R.P.M.				
NC-8322	1"	1-7/16"(36)	200-2000(271-2710)	2500	3390	3300	11.0(311)	90(6.3)	17-5/16"(440)	34.2	15.5	1/2"	93.9	8.8	1/2"
NC-8342	1"	1-7/16"(36)	200-2000(271-2710)	2500	3390	3300	11.0(311)	90(6.3)	24-3/8"(619)	38.0	17.3	1/2"	93.9	8.8	1/2"
NC-8331	1"	1-3/8"(35)	200-2000(271-2711)	2000	2711	4800	9.0(255)	90(6.3)	13-1/2"(346)	16.5	7.5	1/2"	107	10.5	1/2"
NC-8331-6	1"	1-3/8"(35)	200-2000(271-2711)	2000	2711	4800	9.0(255)	90(6.3)	18-1/2"(473)	18.5	8.4	1/2"	107	10.5	1/2"
NC-8332X	1"	1-3/8"(25)	200-2000(271-2710)	2500	3390	4000	8.0(226.5)	90(6.3)	14-11/16"(372.6)	20.7	9.4	3/8"	103.8	8.22	1/2"
NC-8332X-6	1"	1-3/8"(25)	200-2000(271-2710)	2500	3390	4000	8.0(226.5)	90(6.3)	20-43/64"(525)	23.3	10.0	3/8"	103.8	8.22	1/2"
NC-8343	1"	1-3/8"(33)	200-1600(271-2170)	1800	2441	3900	11.5(325)	90(6.3)	15"(381)	27.7	12.5	1/2"	103	6.3	1/2"
NC-8343-8	1"	1-3/8"(33)	200-1600(271-2170)	1800	2441	3900	11.5(325)	90(6.3)	23"(590)	30.6	13.9	1/2"	103	6.3	1/2"
NC-8362	1"	1-7/16"(36)	200-2000(271-2710)	2500	3390	3700	11.0(284)	90(6.3)	17-7/8"(455)	35.2	16.0	1/2"	93.9	8.8	1/2"
NC-8372	1"	1-7/16"(36)	200-2000(271-2710)	2500	3390	3700	11.0(284)	90(6.3)	24-7/32"(615)	38.7	17.6	1/2"	93.9	8.8	1/2"
NC-8382	1"	1-9/16"(40)	200-2000(271-2710)	2500	3390	5000	15.9(450)	90(6.3)	14-17/32"(370)	22.0	11.0	1/2"	100.0	6.4	1/2"
NC-8382-8	1"	1-9/16"(40)	200-2000(271-2710)	2500	3390	5000	15.9(450)	90(6.3)	22-15/32"(570)	27.5	12.5	1/2"	100.0	6.4	1/2"
NC-9223	1-1/2"	2"(50)	200-3000(271-4065)	3500	4746	3000	16.0(453)	90(6.3)	17-3/4"(450)	43.2	19.7	3/4"	104.52	8.86	1/2"
NC-9243	1-1/2"	2"(50)	200-3000(271-4065)	3500	4746	3000	16.0(453)	90(6.3)	24-1/4"(616)	50.2	22.8	3/4"	104.52	8.86	1/2"

AIR IMPACT WRENCH

AIR IMPACT WRENCH

NC-0415-KIT

1/2" DRIVE

5 pieces in one carton

Contents 15 pcs

- 1pc - 1/2" Air Impact Wrench
- 10pcs - Impact sockets, 6 points, standard length 9, 10, 11, 13, 14, 17, 19, 22, 24, 27 mm
- 1pc - Extension bar 5"
- 1pc - Allen Key : 4mm
- 1pc - Mini Oiler 1/4" female x 1/4" male
- 1pc - 1/4" plug



NC-0415M3
NC-4277



NC-0415M4
NC-4213



NC-0415M6
NC-4217



NC-0415M9
NC-4256Q

NC-0425-KIT

1/2" DRIVE

5 pieces in one carton

Contents 15 pcs

- 1pc - 1/2" Air Impact Wrench
- 10pcs - Impact sockets, 6 points, standard length 9, 10, 11, 13, 14, 17, 19, 22, 24, 27 mm
- 1pc - Extension bar 5"
- 1pc - Allen Key : 4mm
- 1pc - Mini Oiler 1/4" female x 1/4" male
- 1pc - 1/4" plug



NC-0425M3
NC-4258



NC-0425M4
NC-4230



NC-0425M5
NC-4233



NC-0425M6
NC-4255Q

NC-0615-KIT

3/4" DRIVE

2 pieces in one carton

Contents 15 pcs

- 1pc - 3/4" Air Impact Wrench
- 8pcs - Impact sockets, 6 points, standard length 26, 27, 29, 30, 32, 35, 36, 38 mm
- 1pc - Extension bar 7"
- 1pc - Universal Joint
- 2pcs - Allen Key : 4mm, 5mm
- 1pc - Mini Oiler 1/4" - 6113, 6215, 3/8" - 6216
- 1pc - 1/4" plug - 6113, 6215, 3/8" plug - 6216
- 1pc - O-Ring&Pin



NC-0615M0
NC-6113



NC-0615M1
NC-6216



NC-0615M2
NC-6215

NC-4232Q-KIT

1/2" DRIVE

5 pieces in one carton

Contents 11 pcs

- 1pc - 1/2" Air Impact Wrench
- 7pcs - Impact sockets, MA411M13, 17, 19, 21, 22, 24, 27
- 1pc - 5" Extension bar
- 1pc - Mini Lubricator SW-12
- 1pc - 1/4" plug



NC-4233Q-KIT

1/2" DRIVE

5 pieces in one carton

Contents 11 pcs

- 1pc - Air Impact Wrench
- 5pcs - Impact sockets MA411M13, 17, 19, 21, 22, 24, 27
- 1pc - 5" Extension bar
- 1pc - Mini Lubricator SW-12
- 1pc - 1/4" plug



NC-4255Q-KIT

1/2" DRIVE

5 pieces in one carton

Contents 11 pcs

- 1pc - 1/2" Air Impact Wrench
- 7pcs - Impact sockets, MA411M13, 17, 19, 21, 22, 24, 27
- 1pc - 5" Extension bar
- 1pc - Mini Lubricator SW-12
- 1pc - 1/4" plug



NC-4255QH-KIT

1/2" DRIVE

5 pieces in one carton

Contents 13 pcs

- 1pc - 1/2" Air Impact Wrench
- 7pcs - Impact sockets, MA411M13L, 17L, 19L, 21L, 22L, 24L, 27L
- 1pc - 5" Extension bar
- 1pc - Mini Lubricator SW-12
- 1pc - 1/4" plug
- 1pc - Grease
- 1pc - Syringe





NC-4255Q-41-KIT

1/2" DRIVE

2 pieces in one carton

Contents 41 pcs

- 1pc - Torque wrench : 42-210 Nm (TE-442210N)
- 3pcs - Thin wall impact socket : 17, 19, 21 mm
- 13pcs - Impact deep socket : 10, 11, 12, 13, 14, 15, 16, 17, 18, 19, 21, 22, 24 mm
- 16pcs - impact socket : 10, 11, 12, 13, 14, 15, 16, 17, 18, 19, 21, 22, 24, 27, 30, 32 mm
- 1pc - Air impact wrench : Max torque 1627 Nm / 1200 FT-LB (NC-4255Q)
- 2pcs - Extension bar : 75 mm, 125 mm (ME421-05 / ME421-03)
- 1pc - Universal joint : 1/2" drive (ME4711)
- 1pc - Air blow gun : 250 mm (JC-410)
- 1pc - Mini lubricator : 1/4" drive (SW-12)
- 2pcs - Air adapter : 1/4" plug



Can be customized

NC-4650-KIT

1/2" DRIVE

5 pieces in one carton

Contents 11 pcs

- 1pc - 1/2 Air Impact Wrench
- 7pcs - Impact sockets, MA411M13, 17, 19, 21, 22, 24, 27
- 1pc - 5" Extension bar
- 1pc - Mini Lubricator SW-12
- 1pc - 1/4" plug



NC-4600-KIT NC-4600-14-KIT

1/2" DRIVE

6 pieces in one carton

Contents 13 pcs

- 1pc - Air Impact Wrench
- 2pcs - Square Head Drive : 3/8" & 1/2"
- 1pc - Lubricating Oil
- 1pc - Release Pin
- 4pcs - Impact Socket : 13, 17, 19, 21 mm
- 1pc - Impact Extension Bar : 14 mm
- 2pcs - Bit Holder : 8 mm & 10 mm
- 1pc - 12 mm Hex Bit
- 1pc - T60 Torx



NC-6236-KIT NC-6236Q-KIT

3/4" DRIVE

5 pieces in one carton

Contents 11 pcs

- 1pc - 3/4" Air Impact Wrench
- 7pcs - Impact sockets, MA611M24, 27, 30, 32, 33, 34, 36
- 1pc - Extension bar
- 1pc - Mini Lubricator SW-12
- 1pc - 1/4" plug



NC-6255Q-KIT

3/4" DRIVE

2 pieces in one carton

Contents 11 pcs

- 1pc - 3/4" Air Impact Wrench
- 7pcs - Impact sockets, MA611M24, 27, 30, 32, 33, 34, 36
- 1pc - Extension bar
- 1pc - Mini Lubricator SW-12
- 1pcs - 1/4" plug



AIR RATCHET WRENCH

AIR RATCHET WRENCH

NE-251 1/4" DRIVE



20 pieces in one carton



NE-351 3/8" DRIVE



20 pieces in one carton



NE-451 1/2" DRIVE



20 pieces in one carton



NE-251R 1/4" DRIVE



20 pieces in one carton



Rubber handle

NE-351R 3/8" DRIVE



20 pieces in one carton



Rubber handle

NE-451R 1/2" DRIVE



20 pieces in one carton



Rubber handle

NE-261 1/4" DRIVE



20 pieces in one carton



NE-361 3/8" DRIVE



20 pieces in one carton



NE-2803 1/4" DRIVE



20 pieces in one carton

· Push-trigger design.



Exhaust

NE-3803 3/8" DRIVE



20 pieces in one carton

· Push-trigger design.



Exhaust

NE-321 3/8" DRIVE



10 pieces in one carton



Exhaust

NE-421 1/2" DRIVE



10 pieces in one carton



Exhaust

Item No.	Square Drive	Torque Range	Max Torque		No Load Speed	Avg. Air Consumption	Air Pressure	Overall Length	Net Weight		Air Hose	Sound Pressure	Vibration Level	Air Inlet
	Inch	ft-lb (Nm)	ft-lb	Nm	R.P.M	CFM (L/min)	PSI (bar)	Inch (mm)	LBS	kg	Inch	dB(A)	m/s ²	Inch
NE-251	1/4"	5-15(6.7-20)	22	30	350	3.0(84.96)	90(6.3)	5"(125)	1.1	0.5	3/8"	89.0	4.4	1/4"
NE-351	3/8"	5-15(6.7-20)	22	30	350	3.0(84.96)	90(6.3)	5"(125)	1.1	0.5	3/8"	89.0	4.4	1/4"
NE-451	1/2"	5-20(6.7-27)	25	33.9	350	3.0(84.96)	90(6.3)	5"(125)	1.1	0.5	3/8"	89.0	4.4	1/4"
NE-251R	1/4"	5-15(6.7-20)	22	30	350	3.0(84.96)	90(6.3)	5"(125)	1.1	0.5	3/8"	89.0	4.4	1/4"
NE-351R	3/8"	5-15(6.7-20)	22	30	350	3.0(84.96)	90(6.3)	5"(125)	1.1	0.5	3/8"	89.0	4.4	1/4"
NE-451R	1/2"	5-20(6.7-27)	25	33.9	350	3.0(84.96)	90(6.3)	5"(125)	1.1	0.5	3/8"	89.0	4.4	1/4"
NE-261	1/4"	10-35(13.5-47)	37	50	230	4.0(130)	90(6.3)	6-5/16"(160)	1.1	0.5	3/8"	88.0	3.0	1/4"
NE-361	3/8"	10-35(13.5-47)	37	50	230	4.0(130)	90(6.3)	6-5/16"(160)	1.1	0.5	3/8"	88.0	3.0	1/4"
NE-2803	1/4"	5-15(7-20)	35	47.6	300	3.6(102)	90(6.3)	8-1/2"(220)	1.4	0.6	3/8"	92.8	3.2	1/4"
NE-3803	3/8"	5-30(7-40)	35	47.6	300	3.6(102)	90(6.3)	8-1/2"(220)	1.4	0.6	3/8"	92.0	3.2	1/4"
NE-321	3/8"	10-35(13.5-47)	50	68	160	4.0(113.28)	90(6.3)	10-3/8"(265)	2.3	1.0	3/8"	91.0	3.9	1/4"
NE-421	1/2"	10-35(13.5-47)	50	68	160	4.0(113.28)	90(6.3)	10-3/8"(265)	2.3	1.0	3/8"	92.8	4.6	1/4"

NE-2900

1/4" DRIVE **NO KICK!!**



20 pieces in one carton

- No force is generated when used.
- Extremely small body that can be grasped with one hand.
- Compact size allows for greater access to tight spaces.
- Lightweight design reduces fatigue.
- Features an impact mechanism; tool remains steady after tightening.



NE-3900

3/8" DRIVE **NO KICK!!**



20 pieces in one carton

NE-3901

3/8" DRIVE **NO KICK!!**



20 pieces in one carton

- Features an impact mechanism; tool remains steady after tightening.



NE-4901

1/2" DRIVE **NO KICK!!**



20 pieces in one carton

- Features an impact mechanism; tool remains steady after tightening.



NE-2905

1/4" DRIVE



20 pieces in one carton

- Suitable for use in confined spaces.
- Usable as a manual ratchet wrench.



NE-3310

3/8" DRIVE



6 pieces in one carton

- Suitable for use in confined spaces.
- Usable as a manual ratchet wrench.



NE-4310

1/2" DRIVE



6 pieces in one carton

- Suitable for use in confined spaces.
- Usable as a manual ratchet wrench.



NE-3305

3/8" DRIVE



10 pieces in one carton



NE-4305

1/2" DRIVE



10 pieces in one carton



Item No.	Square Drive	Torque Range	Max Torque		No Load Speed	Avg. Air Consumption	Air Pressure	Overall Length	Net Weight		Air Hose	Sound Pressure	Vibration Level	Air Inlet
	Inch	ft-lb (Nm)	ft-lb	Nm	R.P.M	CFM (L/min)	PSI (bar)	Inch (mm)	LBS	kg	Inch	dBA	m/s ²	Inch
NE-2900	1/4"	5-35(7.0-47.0)	40	54	1000	3.4(96)	90(6.3)	6-1/4"(160)	1.4	0.7	3/8"	80.0	2.3	1/4"
NE-3900	3/8"	5-35(7.0-47.0)	40	54	1000	3.4(96)	90(6.3)	6-1/4"(160)	1.4	0.7	3/8"	80.0	2.3	1/4"
NE-3901	3/8"	5-35(6.78-47.5)	40	54.2	1100	3.1(88)	90(6.3)	6-1/4"(159)	1.3	0.6	3/8"	89.0	2.2	1/4"
NE-4901	1/2"	10-40(13.5-54)	50	68	1100	3.0(85)	90(6.3)	6-1/4"(159)	1.5	0.7	3/8"	89.0	2.0	1/4"
NE-2905	1/4"	5-15(7-20)	22	30	300	3.0(85)	90(6.3)	11-1/2"(290)	1.9	0.8	3/8"	89.0	4.4	1/4"
NE-3310	3/8"	15-55(20-75)	70	95	160	4.0(113)	90(6.3)	20-7/8"(530)	3.9	1.8	3/8"	82	1.2	1/4"
NE-4310	1/2"	15-55(20-75)	70	95	160	4.0(113)	90(6.3)	20-7/8"(530)	3.9	1.8	3/8"	82	1.2	1/4"
NE-3305	3/8"	15-55(20-75)	70	95	160	5(142)	90(6.3)	15-3/8"(390)	3.5	1.6	3/8"	82	1.2	1/4"
NE-4305	1/2"	15-55(20-75)	70	95	160	5(142)	90(6.3)	15-3/8"(390)	3.5	1.6	3/8"	82	1.2	1/4"

AIR RATCHET WRENCH

AIR RATCHET WRENCH

NE-332 3/8" DRIVE



10 pieces in one carton



NE-432 1/2" DRIVE



10 pieces in one carton



NE-332T 3/8" DRIVE



10 pieces in one carton

· Two step trigger.



NE-432T 1/2" DRIVE



10 pieces in one carton

· Two step trigger.



NE-343 3/8" DRIVE



10 pieces in one carton



NE-443 1/2" DRIVE



10 pieces in one carton



NE-352 3/8" DRIVE 2 in 1



20 pieces in one carton



NE-362 3/8" DRIVE 2 in 1



20 pieces in one carton



NE-3808 3/8" DRIVE



10 pieces in one carton

· Push-trigger design.



NE-4808 1/2" DRIVE



10 pieces in one carton

· Push-trigger design.



NE-383 3/8" DRIVE



10 pieces in one carton

· Two step trigger.



NE-483 1/2" DRIVE



10 pieces in one carton

· Two step trigger.



Item No.	Square Drive	Torque Range	Max Torque		No Load Speed	Avg. Air Consumption	Air Pressure	Overall Length	Net Weight		Air Hose	Sound Pressure	Vibration Level	Air Inlet
	Inch	ft-lb (Nm)	ft-lb	Nm	R.P.M	CFM (L/min)	PSI (bar)	Inch (mm)	LBS	kg	Inch	dBA	m/s ²	Inch
NE-332	3/8"	10-45(13.5-61)	60	81	160	4.0(113.28)	90(6.3)	10-3/8"(265)	3.6	1.2	3/8"	90.5	4.4	1/4"
NE-432	1/2"	10-45(13.5-61)	60	81	160	4.0(113.28)	90(6.3)	10-3/8"(265)	3.6	1.2	3/8"	89.8	5.2	1/4"
NE-332T	3/8"	10-45(13.5-61)	60	81	160	4.0(113.28)	90(6.3)	10-3/8"(265)	3.6	1.2	3/8"	90.5	4.4	1/4"
NE-432T	1/2"	10-45(13.5-61)	60	81	160	4.0(113.28)	90(6.3)	10-3/8"(265)	3.6	1.2	3/8"	89.8	5.2	1/4"
NE-343	3/8"	10-55(13.5-74)	75	101.7	160	4.0(113.28)	90(6.3)	11"(280)	2.8	1.3	3/8"	84.0	4.4	1/4"
NE-443	1/2"	10-55(13.5-74)	100	135.6	160	4.0(113.28)	90(6.3)	11"(280)	2.8	1.3	3/8"	84.0	4.4	1/4"
NE-352	3/8"	5-15(6.7-20)	22	30	350	3.0(84.96)	90(6.3)	5"(125)	1.1	0.5	3/8"	89.0	4.4	1/4"
NE-362	3/8"	10-35(13.5-47)	37	50	230	4.6(130)	90(6.3)	6-5/16"(160)	1.1	0.5	3/8"	89.0	3.0	1/4"
NE-3808	3/8"	10-55(13.5-74)	80	108.8	180	4.0(113)	90(6.3)	12"(300)	2.8	1.3	3/8"	95.0	3.6	1/4"
NE-4808	1/2"	10-55(13.5-74)	80	108.8	180	4.0(113.28)	90(6.3)	12"(280)	2.8	1.3	3/8"	95.0	3.6	1/4"
NE-383	3/8"	15-65(13.5-88)	100	135.6	250	5.0(141)	90(6.3)	10-29/32"(277)	2.8	1.3	3/8"	85	2.0	1/4"
NE-483	1/2"	15-65(13.5-88)	100	135.6	250	5.0(141)	90(6.3)	10-29/32"(277)	2.8	1.3	3/8"	85	2.0	1/4"



NE-462

1/2" DRIVE Pin clutch type



10 pieces in one carton



NE-462T

1/2" DRIVE Pin clutch type



10 pieces in one carton

Two step trigger.



Stylized grip

NE-4815

1/2" DRIVE



10 pieces in one carton

360° Swivel exhaust.



150 FT-LB
204 Nm

NE-488

1/2" DRIVE



12 pieces in one carton



Swivel Exhaust

Item No.	Square Drive	Torque Range	Max Torque		No Load Speed	Avg. Air Consumption	Air Pressure	Overall Length	Net Weight		Air Hose	Sound Pressure	Vibration Level	Air Inlet
	Inch	ft-lb (Nm)	ft-lb	Nm	R.P.M	CFM (L/min)	PSI (bar)	Inch (mm)	LBS	kg	Inch	dBA	m/s ²	Inch
NE-462	1/2"	10-55(13.5-74)	74	100	200	4.0(113.28)	90(6.3)	13"(330)	4.1	1.9	3/8"	84.0	2.5	1/4"
NE-462T	1/2"	10-65(13.5-88)	100	135.6	200	5.0(141)	90(6.3)	13-13/32"(340)	4.0	1.8	3/8"	85.0	2.2	1/4"
NE-4815	1/2"	40-120(54-163)	150	204	170	4.8(136)	90(6.3)	12-1/4"(313)	3.4	1.5	3/8"	93	2.5	1/4"
NE-488	1/2"	10-40(13.5-54)	60	81	150	4.5(127.4)	90(6.3)	10-13/16"(275)	3.2	1.5	3/8"	85.0	3.9	1/4"

NE-0357

3/8" DRIVE



10 pieces in one carton

- 1pc - Air Ratchet Wrench (NE-352)
- 7pcs - 1/4" Dr. socket : 4, 5, 6, 7, 8, 9, 10 mm
- 6pcs - 3/8" Dr. socket : 11, 12, 13, 14, 15, 17 mm
- 40pcs - 1/4" Bits
- 1pc - 3/8" Extension Bar
- 1pc - 1/4" Hex Size shank driver
- 1pc - Plug



NE-0413 KIT NE-0413S KIT

1/2" DRIVE



6 pieces in one carton

- 1pc - Air Ratchet Wrench (NE-461)
- 8pcs - 3/4" Hex Thru-hole socket : 8, 9, 10, 12, 13, 14, 17, 19 mm (NE-0413)
- 8pcs - 3/4" Hex Thru-hole socket : 5/16", 3/8", 7/16", 1/2", 9/16", 5/8", 11/16", 3/4" (NE-0413S)
- 1pc - 3" Extension Bar
- 2pcs - 1/2" 3/8" Adapter
- 1pc - Plug



Perforated adapter.



Item No.	Square Drive	Bolt Capacity	Torque Range	Max Torque		No Load Speed	Avg. Air Consumption	Air Pressure	Overall Length	Net Weight		Air Hose	Sound Pressure	Vibration Level	Air Inlet
	Inch	Inch (mm)	ft-lb (Nm)	ft-lb	Nm	R.P.M	CFM (L/min)	PSI (bar)	Inch (mm)	LBS	kg	Inch	dBA	m/s ²	Inch
NE-352	3/8"	9/16"(14)	5-15(6.7-20)	22	30	350	3.0(84.96)	90(6.3)	5"(125)	1.1	0.5	3/8"	89.0	4.4	1/4"
NE-461	1/2"	9/16"(14)	10-65(13.5-88)	100	135	180	4.0(113)	90(6.3)	10-3/8"(270)	2.6	1.2	3/8"	83.0	2.3	1/4"

AIR RATCHET WRENCH

ONE FOR ALL

MIGHTY POWERFUL NC-0405-KIT

5 in 1 multiple tool kit

AIR RATCHET WRENCH



INE-0405 KIT

1/2" DRIVE 5 IN 1 MULTIPLE TOOL KIT

- ★ ★ ★
 -
 -
 -
 -
 -
- 5 pieces in one carton

- 1pc - NE-9004
- 1pc - QA-9120
- 1pc - QA-9620
- 1pc - QB-9903
- 1pc - QE-2132



60 FT-LB / 81 Nm



• Ratchet NE-9004 1pc



• Air drill QE-2132 1pc



• Angle Grinder QB-9903



• Die Grinder QA-9120



• Angle Die Grinder QA-9620

Item No.	Cylinder Power	Chuck Capacity	No Load Speed	Avg. Air Consumption	Air Pressure	Overall Length	Net Weight	Air Hose	Sound Pressure	Air Inlet
	hp(w)	Inch (mm)	R.P.M	CFM (L/min)	PSI (bar)	Inch (mm)	kg	Inch	dBA	Inch
NE-9004	0.5(372)	1/2"(13)	150	5	90(6.3)	287	1.5	3/8"	82	1/4"
QA-9120	0.5(372)	1/4" & 1/8"(6 & 3)	20000	5	90(6.3)	202	0.7	3/8"	82	1/4"
QA-9620	0.5(372)	1/4" & 1/8"(6 & 3)	14000	5	90(6.3)	208	0.9	3/8"	82	1/4"
QB-9903	0.5(372)	PAD DIA 3"(76)	14000	5	90(6.3)	211	1.0	3/8"	82	1/4"
QE-2132	0.5(372)	3/8"(10)	2500	5	90(6.3)	248	1.1	3/8"	82	1/4"

AIR DIE GRINDER

QA-101 A/B

AIR DIE GRINDER



20 pieces in one carton

Mighty Mini
119 mm



QA-110 A/B

AIR DIE GRINDER



20 pieces in one carton

Stylized grip



QA-111 A/B ^{TOP}

AIR DIE GRINDER



20 pieces in one carton



QA-116 A/B

AIR DIE GRINDER



10 pieces in one carton

13-9/16"(345mm)



Stylized grip



QA-1211 A/B

AIR DIE GRINDER Safety lever type throttle



20 pieces in one carton

- Designed for continuous, long-term factory use.



QA-1221 A/B

AIR DIE GRINDER Safety lever type throttle



20 pieces in one carton

- Designed for continuous, long-term factory use.



QA-2211 A/B

AIR DIE GRINDER Safety lever type throttle



20 pieces in one carton

- Designed for continuous, long-term factory use.



QA-2221 A/B

AIR DIE GRINDER Safety lever type throttle



20 pieces in one carton

- Designed for continuous, long-term factory use.



Item No.	Collet Size	Collet Size	No Load Speed	Avg. Air Consumption	Air Pressure	Overall Length	Motor	Net Weight		Air Hose	Sound Pressure	Vibration Level	Air Inlet
	A mm	B inch	R.P.M	CFM (L/min)	PSI (bar)	Inch (mm)	HP	LBS	kg	Inch	dBA	m/s ²	Inch
QA-101	6 & 3	1/4" & 1/8"	25000	6.3(178)	90(6.3)	4-11/16"(119)	0.3	0.7	0.3	3/8"	80.0	1.4	1/4"
QA-110	6 & 3	1/4" & 1/8"	22000	5.0(141)	90(6.3)	7-5/16"(186)	0.5	1.4	0.6	3/8"	85.0	1.1	1/4"
QA-111	6 & 3	1/4" & 1/8"	25000	10.0(283)	90(6.3)	6"(155)	0.3	0.8	0.4	3/8"	81.5	1.8	1/4"
QA-116	6 & 3	1/4" & 1/8"	22000	5.0(141)	90(6.3)	13-9/16"(345)	0.5	2.5	1.2	3/8"	85.0	1.8	1/4"
QA-1211	3	1/8"	25000	14	90(6.3)	7-11/16"(196)	0.4	1.1	0.5	3/8"	68	0.9	1/4"
QA-1221	6	1/4"	25000	14	90(6.3)	7-11/16"(196)	0.4	1.1	0.5	3/8"	68	0.9	1/4"
QA-2211	3	1/8"	20000	14	90(6.3)	8-7/16"(215)	0.6	1.6	0.7	3/8"	75	0.9	1/4"
QA-2221	6	1/4"	20000	14	90(6.3)	8-7/16"(215)	0.6	1.6	0.7	3/8"	75	0.9	1/4"

AIR DIE GRINDER

AIR DIE GRINDER

QA-131 A/B

AIR DIE GRINDER Roll type throttle



20 pieces in one carton

- Designed for continuous, long-term factory use.



QA-141 A/B

AIR DIE GRINDER



20 pieces in one carton

- Designed for continuous, long-term factory use.
- QA-141-Roll type throttle.



QA-141L A/B

AIR DIE GRINDER



20 pieces in one carton

- Designed for continuous, long-term factory use.
- QA-141L-Lever type throttle.



QA-143 A/B

AIR DIE GRINDER Roll type throttle



12 pieces in one carton

- Designed for continuous, long-term factory use.



QA-151 A/B

AIR DIE GRINDER Roll type throttle



20 pieces in one carton

- Designed for continuous, long-term factory use.



QA-163 A/B

AIR DIE GRINDER



12 pieces in one carton

- Designed for continuous, long-term factory use.
- QA-163-Roll type throttle.



QA-163L A/B

AIR DIE GRINDER



12 pieces in one carton

- Designed for continuous, long-term factory use.
- QA-163L-Lever type throttle.



QA-1710 A/B

EXTENDED AIR DIE GRINDER



10 pieces in one carton



Item No.	Collet Size	Collet Size	No Load Speed	Avg. Air Consumption	Air Pressure	Overall Length	Motor	Net Weight		Air Hose	Sound Pressure	Vibration Level	Air Inlet
	A mm	B inch	R.P.M	CFM (L/min)	PSI (bar)	Inch (mm)	HP	LBS	kg	Inch	dBA	m/s ²	Inch
QA-131													
QA-141													
QA-141L													
QA-143													
QA-151													
QA-163													
QA-163L													
QA-1710													

QA-210 A/B

AIR DIE GRINDER



20 pieces in one carton



QA-211 A/B TOP

AIR DIE GRINDER



20 pieces in one carton



QA-231Q A/B

AIR DIE GRINDER



20 pieces in one carton



QA-241 A/B

AIR DIE GRINDER



20 pieces in one carton



QA-311 A/B

AIR DIE GRINDER



10 pieces in one carton



QA-313 A/B

AIR DIE GRINDER



10 pieces in one carton



QA-315 A/B

AIR DIE GRINDER



10 pieces in one carton



QA-611 A/B

90° AIR ANGLE DIE GRINDER



20 pieces in one carton



QA-6205 A/B

EXTENDED 90° AIR ANGLE DIE GRINDER

Safety lever type throttle



20 pieces in one carton

• Suitable for use in confined spaces.



Item No.	Collet Size	Collet Size	No Load Speed	Avg. Air Consumption	Air Pressure	Overall Length	Motor	Net Weight		Air Hose	Sound Pressure	Vibration Level	Air Inlet
	A mm	B inch	R.P.M	CFM (L/min)	PSI (bar)	Inch (mm)	HP	LBS	kg	Inch	dBA	m/s ²	Inch
QA-210	6	1/4"	20000	10.0(283)	90(6.3)	7-1/2"(190)	0.9	1.4	0.7	3/8"	75.7	0.8	1/4"
QA-211	6 & 3	1/4" & 1/8"	20000	10.0(283)	90(6.3)	7-1/2"(190)	0.9	1.4	0.7	3/8"	75.7	0.8	1/4"
QA-231Q	6 & 3	1/4" & 1/8"	20000	14.8(420)	90(6.3)	5-29/32"(150)	0.45	0.8	0.4	3/8"	80.0	>2.5	1/4"
QA-241	6 & 3	1/4" & 1/8"	4000	10.6(283)	90(6.3)	8-5/8"(220)	0.5	1.6	0.8	3/8"	75.0	0.87	1/4"
QA-311	6 & 3	1/4" & 1/8"	25000	10.0(283)	90(6.3)	7-1/2"(190)	0.3	1.0	0.5	3/8"	81.5	1.8	1/4"
QA-313	6 & 3	1/4" & 1/8"	25000	10.0(283)	90(6.3)	9-1/4"(235)	0.5	1.2	0.6	3/8"	81.5	1.8	1/4"
QA-315	6 & 3	1/4" & 1/8"	25000	10.0(283)	90(6.3)	11"(280)	0.3	1.4	0.6	3/8"	81.5	1.8	1/4"
QA-611	6 & 3	1/4" & 1/8"	19000	10.0(283)	90(6.3)	6-1/8"(160)	0.3	1.1	0.5	3/8"	74.4	1.7	1/4"
QA-6205	6	1/4"	14500	3.5	90(6.3)	12-1/8"(308)	0.5	2.1	1.0	3/8"	85.0	1.8	1/4"

AIR DIE GRINDER

AIR DIE GRINDER

QA-632Q A/B 97° AIR ANGLE DIE GRINDER

★★★
20 pieces in one carton



QA-633Q A/B 97° AIR ANGLE DIE GRINDER

★★★
20 pieces in one carton



QA-681 A/B AIR ANGLE DIE GRINDER

★★★
10 pieces in one carton



QA-688 A/B AIR DIE GRINDER FLEX-HEAD

★★★
10 pieces in one carton

- Flexible head for accessing hard-to-reach areas.
- Small tool for spot sanding and finishing applications.
- Ideal for automotive aftermarket and light industry.



Item No.	Collet Size	Collet Size	No Load Speed	Avg. Air Consumption	Air Pressure	Overall Length	Motor	Net Weight		Air Hose	Sound Pressure	Vibration Level	Air Inlet
	A mm	B inch	R.P.M	CFM (L/min)	PSI (bar)	Inch (mm)	HP	LBS	kg	Inch	dBA	m/s ²	Inch
QA-632Q													
QA-632Q	6 & 3	1/4" & 1/8"	22000	12.3(350)	90(6.3)	7"(177)	0.4	1.1	0.5	3/8"	75.0	2.5	1/4"
QA-633Q	6 & 3	1/4" & 1/8"	15000	17.2(490)	90(6.3)	7-1/8"(180)	0.6	1.5	0.7	3/8"	78	2.5	1/4"
QA-681	6 & 3	1/4" & 1/8"	20000	5.0(141)	90(6.3)	7-11/16"(195)	0.5	1.8	0.8	3/8"	85.0	1.8	1/4"
QA-688	6 & 3	1/4" & 1/8"	20000	10(283)	90(6.3)	7"(178)	0.3	1.4	0.7	3/8"	80.0	1.1	1/4"

QA-0115 A/B QA-0215 A/B AIR DIE GRINDER 15PCS KIT

★★★
10 pieces in one carton

- 1pc - Air Die Grinder (QA-111 / QA-211)
- 1pc - Collet (3 mm or 1/8")
- 2pcs - Spanner Wrench
- 5pcs - Grinder Stone (3 mm or 1/8")
- 5pcs - Shank Stone (6 mm or 1/4")
- 1pc - Plug (adapter)



QA-0207 A/B AIR DIE GRINDER 7PCS KIT

★★★
10 pieces in one carton

- 1pc - Air Die Grinder (QA-210)
- 5pcs - Shank stone (6mm or 1/4")
- 1pc - Plug (adapter)



QA-0615 A/B AIR DIE GRINDER 15PCS KIT

★★★
10 pieces in one carton

- 1pc - Air Die Grinder(QA-611)
- 1pc - Collet (3 mm or 1/8")
- 2pcs - Spanner Wrench
- 5pcs - Grinder Stone (3 mm or 1/8")
- 5pcs - Shank Stone (6 mm or 1/4")
- 1pc - Plug (adapter)



QA-111



QA-211



QA-210

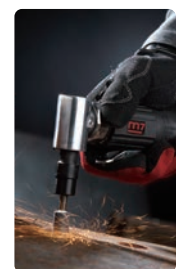

QA-611

MICRO AIR DIE GRINDER

QA-441 A/B

MICRO AIR DIE GRINDER

A : 3 mm B : 1/8"



20 pieces in one carton



QA-412 A/B

MICRO AIR DIE GRINDER

A : 3 mm B : 1/8"



20 pieces in one carton



QA-421 A/B

MICRO AIR DIE GRINDER

A : 3 mm B : 1/8"



20 pieces in one carton



QA-431 A/B

MICRO AIR DIE GRINDER

A : 3 mm B : 1/8"



10 pieces in one carton



QA-432 A/B

MICRO AIR DIE GRINDER

A : 3 mm B : 1/8"



20 pieces in one carton



QA-4507 A/B

MICRO AIR DIE GRINDER

A : 6 mm B : 1/4"



10 pieces in one carton



High cost-performance ratio.

QA-511

ENGRAVING PEN



20 pieces in one carton



Item No.	Collet Size	Collet Size	No Load Speed	Blow Per Minute	Avg. Air Consumption	Air Pressure	Overall Length	Hose Length	Net Weight		Air Hose	Sound Pressure	Vibration Level	Air Inlet
	A mm	B inch	R.P.M	bpm	CFM (L/min)	PSI (bar)	Inch (mm)	mm	LBS	kg	Inch	dBA	m/s ²	Inch
QA-441														
QA-441	3	1/8"	60000	---	2.0(56)	90(6.3)	5-5/16"(135)	1500	0.4	0.2	3/8"	71.0	1.0	1/4"
QA-412	3	1/8"	60000	---	2.7(76)	90(6.3)	6-3/4"(170)	1500	0.5	0.2	3/8"	70.0	0.5	1/4"
QA-421	3	1/8"	60000	---	2.7(76)	90(6.3)	6"(150)	1500	0.5	0.2	3/8"	70.0	0.5	1/4"
QA-431	3	1/8"	54000	---	2.0(56)	90(6.3)	5-3/8"(137)	1425	0.4	0.2	3/8"	70.0	0.5	1/4"
QA-432	3	1/8"	70000	---	1.0(29)	90(6.3)	5-3/8"(137)	1425	0.4	0.2	3/8"	70.0	0.5	1/4"
QA-4507	6	1/4"	32000	---	4.0(113)	90(6.3)	14-11/32"(364)	1500	0.9	0.4	3/8"	85.0	1.2	1/4"
QA-511	---	---	---	13000	1.0(29)	90(6.3)	5-1/2"(140)	1420	0.5	0.2	3/8"	78.0	0.6	1/4"

AIR ANGLE GRINDER

• Note : The grinding wheel is not supplied along with the tool.

QB-1004

Roll type throttle



6 pieces in one carton



QB-104X

Roll type throttle



10 pieces in one carton



QB-105X

Roll type throttle



10 pieces in one carton



QB-114X

Roll type throttle



10 pieces in one carton



QB-115X

Roll type throttle



10 pieces in one carton



QB-117

Roll type throttle



6 pieces in one carton



QB-124

Roll type throttle



10 pieces in one carton



QB-125

Roll type throttle



10 pieces in one carton



QB-134X

Roll type throttle



10 pieces in one carton



QB-135X

Roll type throttle



10 pieces in one carton



QB-154X

Roll type throttle



10 pieces in one carton



QB-155X

Roll type throttle



10 pieces in one carton



Item No.	Pad Dia / Arbor Size	Spindle Size	No Load Speed	Avg. Air Consumption	Air Pressure	Overall Length	Motor	Net Weight		Air Hose	Sound Pressure	Vibration Level	Air Inlet
	inch(mm)		R.P.M	CFM (L/min)	PSI (bar)	Inch (mm)	HP	LBS	kg	Inch	dBA	m/s ²	Inch
QB-1004	4"(100x16)	M8x1.25	13500	4.9(138)	90(6.3)	7-3/32"(215)	0.6	2.6	1.2	3/8"	85.0	2.5	1/4"
QB-104X	4"(100x16)	3/8"-24	11000	6.0(170)	90(6.3)	8-7/8"(226)	0.78	4.0	1.8	3/8"	87.8	1.2	1/4"
QB-105X	5"(125x22)	5/8"-11	11000	6.0(170)	90(6.3)	8-7/8"(226)	0.78	4.0	1.8	3/8"	87.1	1.2	1/4"
QB-114X	4"(100x16)	3/8"-24	11000	6.0(170)	90(6.3)	9"(230)	0.78	4.0	1.8	3/8"	87.8	1.2	1/4"
QB-115X	5"(125x22)	5/8"-11	11000	6.0(170)	90(6.3)	9"(230)	0.78	4.0	1.8	3/8"	87.1	1.2	1/4"
QB-117	7"(178x22)	M14xP2.0	7000	9.0(255)	90(6.3)	13-1/2"(343)	1.0	7.1	3.2	1/2"	89.7	1.0	1/4"
QB-124	4"(100x16)	3/8"-24	11000	6.0(170)	90(6.3)	9"(230)	0.78	3.8	1.7	3/8"	85.7	3.0	1/4"
QB-125	5"(125x22)	5/8"-11	11000	6.0(170)	90(6.3)	9"(230)	0.78	3.9	1.8	3/8"	87.0	5.9	1/4"
QB-134X	4"(100x16)	M10xP1.5	11000	6.0(170)	90(6.3)	9"(230)	0.78	4.0	1.8	3/8"	89.0	1.2	1/4"
QB-135X	5"(125x22)	M14xP2.0	11000	6.0(170)	90(6.3)	9"(230)	0.78	4.0	1.8	3/8"	89.0	1.2	1/4"
QB-154X	4"(100x16)	3/8"-24	11000	6.0(170)	90(6.3)	9"(230)	0.78	3.8	1.7	3/8"	89.0	1.2	1/4"
QB-155X	5"(125x22)	5/8"-11	11000	6.0(170)	90(6.3)	9"(230)	0.78	3.8	1.7	3/8"	89.0	1.2	1/4"

• Note : The grinding wheel is not supplied along with the tool.

QB-144X

Roll type throttle



10 pieces in one carton



QB-145X

Roll type throttle



10 pieces in one carton



QB-164X

Roll type throttle



10 pieces in one carton



QB-165X

Roll type throttle



10 pieces in one carton



QB-177

Roll type throttle



6 pieces in one carton



QB-179

AIR VERTICAL GRINDER
Lever type throttle



4 pieces in one carton



QB-185

AIR VERTICAL GRINDER
Lever type throttle



4 pieces in one carton



QB-187

AIR VERTICAL GRINDER
Lever type throttle



4 pieces in one carton



QB-192

Roll type throttle



10 pieces in one carton



QB-192L

Lever type throttle



10 pieces in one carton



QB-193

Roll type throttle



10 pieces in one carton



QB-193L

Lever type throttle



10 pieces in one carton



Item No.	Pad Dia / Arbor Size	Spindle Size	No Load Speed	Avg. Air Consumption	Air Pressure	Overall Length	Motor	Net Weight		Air Hose	Sound Pressure	Vibration Level	Air Inlet
	inch(mm)		R.P.M	CFM (L/min)	PSI (bar)	Inch (mm)	HP	LBS	kg	Inch	dBA	m/s ²	Inch
QB-144X	4"(100x16)	M10xP1.5	11000	6.0(170)	90(6.3)	8-7/8"(225)	0.78	4.0	1.8	3/8"	89.0	1.2	1/4"
QB-145X	5"(125x22)	M14xP2.0	11000	6.0(170)	90(6.3)	8-7/8"(225)	0.78	4.0	1.8	3/8"	89.0	1.2	1/4"
QB-164X	4"(100x16)	3/8"-24	11000	6.0(170)	90(6.3)	8-7/8"(225)	0.78	4.0	1.8	3/8"	89.0	1.2	1/4"
QB-165X	5"(125x22)	5/8"-11	11000	6.0(170)	90(6.3)	8-7/8"(225)	0.78	4.0	1.8	3/8"	89.0	1.2	1/4"
QB-177	7"(178x22)	5/8"-11	7600	6.0(170)	90(6.3)	11-13/16"(300)	2.0	7.2	3.3	3/8"	92.0	2.7	1/4"
QB-179	9"(230x22)	5/8"-11	6000	7.0(198)	90(6.3)	11"(279)	3.8	13.2	6.0	3/4"	86.0	2.1	1/2"
QB-185	5"(125x22)	5/8"-11	12000	6.0(170)	90(6.3)	9-9/64"(232)	1.4	6.2	2.8	1/2"	86.0	2.1	1/4"
QB-187	7"(178x22)	5/8"-11	7000	6.0(170)	90(6.3)	9-23/32"(247)	2.0	8.8	4.0	1/2"	86.0	2.1	1/4"
QB-192	2"(50)	1/4"-28	15000	5.3(150)	90(6.3)	8-7/8"(226)	0.36	1.3	0.6	3/8"	81.0	2	3/8"
QB-192L	2"(50)	1/4"-28	15000	5.3(150)	90(6.3)	7-1/2"(190)	0.36	1.6	0.7	3/8"	81.0	2	3/8"
QB-193	3"(75)	M8	13500	5.8(164)	90(6.3)	7-1/8"(180)	0.44	2.4	1.1	3/8"	85.0	2.5	3/8"
QB-193L	3"(75)	M8	13500	5.8(164)	90(6.3)	7-3/4"(197)	0.44	2.4	1.1	3/8"	85.0	2.5	3/8"

AIR ANGLE GRINDER

• Note : The grinding wheel is not supplied along with the tool.

QB-194

Roll type throttle



10 pieces in one carton



QB-194L

Lever type throttle



6 pieces in one carton



QB-194CN

Roll type throttle



9 pieces in one carton



QB-195-85

Roll type throttle



10 pieces in one carton



QB-195-120

Roll type throttle



10 pieces in one carton



QB-195L-85

Lever type throttle



6 pieces in one carton



QB-195L-120

Lever type throttle



6 pieces in one carton



QB-195CN

Roll type throttle



9 pieces in one carton



QB-197Q

Lever type throttle



6 pieces in one carton



QB-199 S/M

Lever type throttle



4 pieces in one carton



QB-623

2" AIR ANGLE GRINDER

Lever type throttle



10 pieces in one carton



AIR ANGLE GRINDER

Item No.	Pad Dia / Arbor Size	Spindle Size	No Load Speed	Avg. Air Consumption	Air Pressure	Overall Length	Motor	Net Weight		Air Hose	Sound Pressure	Vibration Level	Air Inlet
	inch(mm)		R.P.M	CFM (L/min)	PSI (bar)	Inch (mm)		HP	LBS	kg	Inch	dBA	m/s ²
QB-194	4"(100x16)	M8x1.25	12000	4.9(138)	90(6.3)	8-15/32"(215)	0.9	4.2	1.9	3/8"	91.0	2.6	3/8"
QB-194L	4"(100x16)	M8x1.25	12000	4.9(138)	90(6.3)	10-23/32"(272)	0.9	4.6	2.1	3/8"	89.0	2.5	3/8"
QB-194CN	4"(100x16)	M8x1.25	13500	4.8(136)	90(6.3)	8-15/64"(210)	0.8	4.2	1.9	3/8"	92.0	2.8	3/8"
QB-195-85	5"(125x22)	1/2"-13	8500	4.9(138)	90(6.3)	8-15/16"(227)	1.5	5.3	2.4	3/8"	91	2.1	3/8"
QB-195-120	5"(125x22)	1/2"-13	12000	5.1(144)	90(6.3)	8-15/16"(227)	1.4	5.3	2.4	3/8"	91	2.1	3/8"
QB-195L-85	5"(125x22)	1/2"-13	8500	4.9(138)	90(6.3)	10-13/16"(275)	1.5	5.5	2.5	3/8"	91	2.1	3/8"
QB-195L-120	5"(125x22)	1/2"-13	12000	5.1(144)	90(6.3)	10-13/16"(275)	1.5	5.5	2.5	3/8"	91	2.1	3/8"
QB-195CN	5"(125x22)	M8x1.25	12000	4.9(138)	90(6.3)	8-15/32"(215)	1.3	4.4	2.0	3/8"	91	2.6	3/8"
QB-197Q	7"(178x22)	5/8"-11	7000	6.0(170)	90(6.3)	13-15/16"(353)	2.2	6.8	3.1	3/8"	77.0	2.4	3/8"
QB-199(S/M)	9"(230x22)	5/8"-11 / M14xP2.0	5900	6.8(178)	90(6.3)	14"(360)	2.5	9.9	4.5	3/8"	98.0	3.75	3/8"
QB-623	2"(50x10)	M14xP2.0	19000	6.8(178)	90(6.3)	14"(360)	2.5	9.9	4.5	3/8"	98.0	3.75	3/8"



• Note : The grinding wheel is not supplied along with the tool.

QB-2925

AIR STRAIGHT GRINDER

Roll type throttle



12 pieces in one carton



Used with straight grinding wheel

QB-2925L

AIR STRAIGHT GRINDER

Lever type throttle



12 pieces in one carton



Used with straight grinding wheel

QB-7214 S/M

100° 1.3HP AIR ANGLE GRINDER

Lever type throttle



6 pieces in one carton



• Quick-release guard design, making angle adjustments easy.

QB-7215 S/M

100° 1.3HP AIR ANGLE GRINDER

Lever type throttle



6 pieces in one carton

• Quick-release guard design, making angle adjustments easy.



QB-7245 S/M

100° 1.3HP AIR ANGLE GRINDER

Lever type throttle



6 pieces in one carton

• Quick-release guard design, making angle adjustments easy.



QB-7315 S/M

2.3HP AIR ANGLE GRINDER

Lever type throttle



6 pieces in one carton



Item No.	Pad Dia / Arbor Size	Spindle Size	No Load Speed	Avg. Air Consumption	Air Pressure	Overall Length	Motor	Net Weight		Air Hose	Sound Pressure	Vibration Level	Air Inlet
	inch(mm)		R.P.M	CFM (L/min)	PSI (bar)			hp	LBS	kg	Inch	dBA	m/s ²
QB-2925													
QB-2925	(65x13x9.5)	3/8"-16	16000	5.0(141)	90(6.3)	10-11/16"(270)	0.9	2.9	1.3	3/8"	90	2.8	3/8"
QB-2925L	(65x13x9.5)	3/8"-16	16000	5.0(141)	90(6.3)	12-25/32"(324)	0.9	3.0	1.4	3/8"	90	2.8	3/8"
QB-7214(S/M)	4"(100)	3/8"-24 / M10xP1.5	11000	4.2(119)	90(6.3)	9-1/8"(232)	1.3	4.0	1.8	3/8"	90.0	1.2	1/4"
QB-7215(S/M)	5"(125)	5/8"-11 / M14xP2.0	11000	4.2(119)	90(6.3)	9-1/8"(232)	1.3	4.0	1.8	3/8"	90.0	1.2	1/4"
QB-7245(S/M)	4-1/2"(115)	5/8"-11 / M14xP2.0	11000	4.2(119)	90(6.3)	9-1/8"(232)	1.3	4.0	1.8	3/8"	90.0	1.2	1/4"
QB-7315(S/M)	5"(125)	5/8"-11 / M14xP2.0	10000	6.9(195)	90(6.3)	9-1/4"(234)	2.3	4.0	1.8	1/2"	88	3.8	1/4"

AIR BELT SANDER

AIR BELT SANDER

QB-311

AIR BELT SANDER



10 pieces in one carton



QB-312

AIR BELT SANDER



10 pieces in one carton



QB-313

AIR BELT SANDER



6 pieces in one carton



QB-321

AIR BELT SANDER



10 pieces in one carton



QB-322

AIR BELT SANDER



10 pieces in one carton



QB-322C

AIR BELT SANDER



10 pieces in one carton



· Rubber pulley

QB-322RC

AIR BELT SANDER - ANGLE FELXIBLE



10 pieces in one carton



QB-324

AIR BELT SANDER



10 pieces in one carton



QB-325N [SET]

AIR BELT SANDER



4 pieces in one carton



QB-325P54

QB-325P53

QB-325P04

QB-325P52

Item No.	Belt Size Pad Dia	No Load Speed	Avg. Air Consumption	Air Pressure	Overall Length	Net Weight		Air Hose	Sound Pressure	Vibration Level	Air Inlet
	inch(mm)	R.P.M	CFM (L/min)	PSI (bar)	Inch (mm)	LBS	kg	Inch	dBA	m/s ²	Inch
QB-311	3/8"x13"(10x330)	16000	8.0(226)	90(6.3)	11-1/2"(290)	1.8	0.8	3/8"	89.7	0.5	1/4"
QB-312	3/4"x20-1/2"(20x520)	16000	9.0(254)	90(6.3)	14"(360)	2.7	1.2	3/8"	91.8	0.4	1/4"
QB-313	1-3/16"x21-1/4"(30x540)	13000	10.0(283)	90(6.3)	15-3/8"(390)	5.3	2.4	3/8"	81.0	1.2	1/4"
QB-321	3/8"x13"(10x330)	16000	4.0(113)	90(6.3)	12-5/8"(320)	2.1	1.0	3/8"	88.0	1.0	1/4"
QB-322	3/4"x20-1/2"(20x520)	16000	4.0(113)	90(6.3)	17"(430)	3.1	1.4	3/8"	88.0	1.3	1/4"
QB-322C	3/4"x20-1/2"(20x520)	16000	4.0(113)	90(6.3)	17"(430)	3.1	1.4	3/8"	88.0	1.3	1/4"
QB-322RC	3/4"x20-1/2"(20x520)	16000	4.0(113)	90(6.3)	17"(430)	3.1	1.4	3/8"	88.0	1.3	1/4"
QB-324	1/2"x24"(12.7x610)	16000	4.0(113)	90(6.3)	18"(455)	2.4	1.0	3/8"	88.0	1.1	1/4"
QB-325N(P04)	3/8"x13"(10x330)	16000	4.0(113)	90(6.3)	12-5/8"(320)	2.1	1.0	3/8"	90	1.1	1/4"
QB-325N(P52)	1/4"x13"(6x330)	16000	4.0(113)	90(6.3)	12-5/8"(320)	2.1	1.0	3/8"	90	1.1	1/4"
QB-325N(P53)	3/4"x13"(20x330)	16000	4.0(113)	90(6.3)	12-5/8"(320)	2.1	1.0	3/8"	90	1.1	1/4"
QB-325N(P54)	3/4"x20-1/2"(20x520)	16000	4.0(113)	90(6.3)	12-5/8"(320)	2.1	1.0	3/8"	90	1.1	1/4"

AIR SANDER

Non-Vacuum SERIES



QB-42

AIR RANDOM ORBITAL SANDER
Non-Vacuum



8 pieces in one carton

- 5" QB-42502 5mm orbit
- 6" QB-42602 5mm orbit



QB-46

AIR RANDOM ORBITAL SANDER
Non-Vacuum



10 pieces in one carton

- 5" QB-46502 5mm orbit
- 5" QB-46512 2.5mm orbit
- 6" QB-46602 5mm orbit
- 6" QB-46612 2.5mm orbit



QB-49602

DUAL ACTION SANDER
Non-Vacuum 9.5mm orbit



10 pieces in one carton



QB-52

AIR RANDOM ORBITAL SANDER
Non-Vacuum



8 pieces in one carton

- 5" QB-52502 5mm orbit
- 6" QB-52602 5mm orbit



QB-55

AIR RANDOM ORBITAL SANDER
Non-Vacuum



12 pieces in one carton

- 3" QB-55312 2.5mm orbit
- 5" QB-55502 5mm orbit
- 6" QB-55602 5mm orbit

QB-55312



QB-58502

AIR 2-HAND RANDOM ORBITAL SANDER
Non-Vacuum 5mm orbit



6 pieces in one carton



QB-58602

AIR 2-HAND RANDOM ORBITAL SANDER
Non-Vacuum 5mm orbit



6 pieces in one carton



Non-Vacuum Sander Accessories

Velcro Or Vinyl Sanding Pad Both Available

Backing Face : velcro

Backing Face : vinyl



ITEM NO.	SIZE	Max R.P.M
QB-9302	2"	15000
QB-9303	3"	15000
QB-9305	5"	12000
QB-9306	6"	12000

Blister+Card



ITEM NO.	SIZE	Max R.P.M
QB-9345	5"	12000
QB-9307	6"	12000

Blister+Card

Item No.	Pad Dia	No Load Speed	Avg. Air Consumption	Air Pressure	Overall Length	Motor	Net Weight		Air Hose	Sound Pressure	Vibration Level	Orbit	Air Inlet
	inch(mm)	R.P.M	CFM (L/min)	PSI (bar)	Inch (mm)	HP	LBS	kg	Inch	dBA	m/s ²	mm	Inch
QB-42502	5"(127)	10000	3.85(109)	90(6.3)	6"(153)	0.24	1.7	0.8	3/8"	75.7	1.4	5	1/4"
QB-42602	6"(152)	10000	3.85(109)	90(6.3)	6-1/2"(166)	0.24	1.8	0.9	3/8"	74.4	1.4	5	1/4"
QB-46502	5"(127)	10000	3.85(109)	90(6.3)	6"(153)	0.24	1.7	0.8	3/8"	80.1	2.2	5	1/4"
QB-46512	5"(127)	10000	3.85(109)	90(6.3)	6"(153)	0.24	1.7	0.8	3/8"	80.1	2.2	2.5	1/4"
QB-46602	6"(152)	10000	3.85(109)	90(6.3)	6-1/2"(166)	0.24	1.7	0.8	3/8"	80.1	2.2	5	1/4"
QB-46612	6"(152)	10000	3.85(109)	90(6.3)	6-1/2"(166)	0.24	1.7	0.8	3/8"	80.1	2.2	2.5	1/4"
QB-49602	6"(152)	10000	3.60(102)	90(6.3)	8-21/32"(220)	0.75	2.0	0.9	3/8"	92.5	3.3	9.5	1/4"
QB-52502	5"(127)	10000	6.0(170)	90(6.3)	6"(153)	0.24	2.2	1.0	3/8"	87.6	1.2	5	1/4"
QB-52602	6"(152)	10000	6.0(170)	90(6.3)	6-1/2"(166)	0.24	2.7	1.2	3/8"	87.6	1.7	5	1/4"
QB-55312	3"(76)	11000	3.0(85)	90(6.3)	5-1/8"(157)	0.24	1.5	0.7	3/8"	81.6	1.5	2.5	1/4"
QB-55502	5"(127)	10000	3.0(85)	90(6.3)	6-11/16"(170)	0.24	1.5	0.7	3/8"	81.6	1.5	5	1/4"
QB-55602	6"(152)	10000	3.0(85)	90(6.3)	6-11/16"(170)	0.24	1.5	0.7	3/8"	81.6	1.5	5	1/4"
QB-58502	5"(127)	10000	3.10(88)	90(6.3)	9-7/16"(240)	0.4	2.6	1.2	3/8"	80.0	1.3	5	1/4"
QB-58602	6"(152)	10000	3.10(88)	90(6.3)	9-7/16"(240)	0.4	2.6	1.2	3/8"	80.0	1.3	5	1/4"

AIR SANDER

AIR SANDER



Self-Generated Vacuum

SERIES



QB-20203

AIR RANDOM ORBITAL SANDER
Self-Vacuum



20 pieces in one carton

- Note : 2" Sanding pad & 3" Sanding is supplied along with the tool.



QB-43

AIR RANDOM ORBITAL SANDER
Self-Generated Vacuum



6 pieces in one carton

- 5" QB-43802 5mm orbit
- 6" QB-43902 5mm orbit



QB-47

AIR RANDOM ORBITAL SANDER
Self-Generated Vacuum



6 pieces in one carton

- 6" QB-47602 5mm orbit
- 6" QB-47612 2.5mm orbit



QB-53

AIR RANDOM ORBITAL SANDER
Self-Generated Vacuum



8 pieces in one carton

- 5" QB-53802 5mm orbit
- 6" QB-53902 5mm orbit



QB-56

AIR RANDOM ORBITAL SANDER
Self-Generated Vacuum



12 pieces in one carton

- 5" QB-56502 5mm orbit
- 6" QB-56602 5mm orbit



QB-59602

AIR 2-HAND RANDOM ORBITAL SANDER
Self-Generated Vacuum



6 pieces in one carton



Air Regulator

Item No.	Pad Dia	No Load Speed	Avg. Air Consumption	Air Pressure	Overall Length	Motor	Net Weight		Air Hose	Sound Pressure	Vibration Level	Orbit	Air Inlet
	inch(mm)	R.P.M	CFM (L/min)	PSI (bar)	Inch (mm)	HP	LBS	kg	Inch	dB(A)	m/s ²	mm	Inch
QB-20203	2" + 3"	14000	3.0(85)	90(6.3)	5-1/8"(130)	---	1.1	0.5	3/8"	81.6	1.5	3.0	1/4"
QB-43802	5"(127)	10000	3.85(109)	90(6.3)	8"(206)	0.24	3.3	1.5	3/8"	83.9	1.3	5	1/4"
QB-43902	6"(152)	10000	3.85(109)	90(6.3)	8-3/4"(221)	0.24	3.4	1.5	3/8"	83.0	1.4	5	1/4"
QB-47602	6"(152)	10000	3.85(109)	90(6.3)	7-1/2"(193)	0.24	2.5	1.1	3/8"	84.7	2.2	5	1/4"
QB-47612	6"(152)	10000	3.85(109)	90(6.3)	7-1/2"(193)	0.24	2.5	1.1	3/8"	84.7	2.2	2.5	1/4"
QB-53802	5"(127)	10000	6(170)	90(6.3)	6"(153)	0.24	2.2	1.0	3/8"	86.2	1.1	5	1/4"
QB-53902	6"(152)	10000	6(170)	90(6.3)	6-1/2"(166)	0.24	2.7	1.2	3/8"	80.1	1.2	5	1/4"
QB-56502	5"(127)	10000	3.0(85)	90(6.3)	8-1/4"(210)	0.24	1.7	0.8	3/8"	81.6	1.5	5	1/4"
QB-56602	6"(152)	10000	3.0(85)	90(6.3)	8-1/4"(210)	0.24	1.7	0.8	3/8"	81.6	1.5	5	1/4"
QB-59602	6"(152)	10000	3.10(88)	90(6.3)	9-7/16"(240)	0.4	2.6	1.2	3/8"	80.0	1.3	5	1/4"



Central-Vacuum
SERIES



QB-41

AIR RANDOM ORBITAL SANDER
Central-Vacuum



8 pieces in one carton

- 6" QB-41902 5mm orbit



QB-45

AIR RANDOM ORBITAL SANDER
Central-Vacuum



10 pieces in one carton

- 6" QB-45602 5mm orbit
- 6" QB-45612 2.5mm orbit



QB-54

AIR RANDOM ORBITAL SANDER
Central-Vacuum



12 pieces in one carton

- 5" QB-54502
- 6" QB-54602 (six hole pad)
- 6" QB-54702 (fifteen hole pad)



QB-51602

AIR RANDOM ORBITAL SANDER
Central-Vacuum



12 pieces in one carton

- 6" QB-51602 5mm orbit



QB-51612

AIR RANDOM ORBITAL SANDER
Central-Vacuum



12 pieces in one carton

- 6" QB-51612 2.5mm orbit



QB-57602

AIR 2-HAND RANDOM ORBITAL SANDER
Central-Vacuum 5mm orbit



6 pieces in one carton



Air Regulator

Item No.	Pad Dia	No Load Speed	Avg. Air Consumption	Air Pressure	Overall Length	Motor	Net Weight		Air Hose	Sound Pressure	Vibration Level	Orbit	Air Inlet
	inch(mm)	R.P.M	CFM (L/min)	PSI (bar)	Inch (mm)	HP	LBS	kg	Inch	dBA	m/s ²	mm	Inch
QB-41902	6"(152)	10000	3.85(109)	90(6.3)	8"(206)	0.24	2.0	0.9	3/8"	81.5	1.2	5	1/4"
QB-45602	6"(152)	10000	3.85(109)	90(6.3)	7-1/2"(193)	0.24	1.9	0.8	3/8"	81.6	2.2	5	1/4"
QB-45612	6"(152)	10000	3.85(109)	90(6.3)	7-1/2"(193)	0.24	1.9	0.8	3/8"	81.6	2.2	2.5	1/4"
QB-54502	5"(127)	10000	3.0(85)	90(6.3)	7-3/4"(197)	0.24	1.7	0.8	3/8"	81.6	1.5	5	1/4"
QB-54602	6"(152)	10000	3.0(85)	90(6.3)	8-1/4"(210)	0.24	1.7	0.8	3/8"	81.6	1.5	5	1/4"
QB-54702	6"(152)	10000	3.0(85)	90(6.3)	8-1/4"(210)	0.24	1.7	0.8	3/8"	81.6	1.5	5	1/4"
QB-51602	6"(152)	12000	3.0(85)	90(6.3)	8-7/8"(225)	0.24	2	0.9	3/8"	81.6	1.5	5	1/4"
QB-51612	6"(152)	12000	3.0(85)	90(6.3)	8-7/8"(225)	0.24	2	0.9	3/8"	81.6	1.5	5	1/4"
QB-57602	6"(152)	10000	3.10(88)	90(6.3)	9-7/16"(240)	0.40	2.6	1.2	3/8"	80.0	1.3	5	1/4"

AIR SANDER

AIR SANDER



Air Gear Driven Sander



QB-57642

AIR 2-HAND RANDOM ORBITAL SANDER
Central-Vacuum



6 pieces in one carton

- Low-speed, high-torque eccentric design for gravity grinding, quickly removes surface materials (paint/rust/...).



Equipped with QB-57642P39
6-hole Vacuum Pad



QB-57642P39

QB-59642

AIR 2-HAND RANDOM ORBITAL SANDER
Self-Generated Vacuum



6 pieces in one carton

- Low-speed, high-torque eccentric design for gravity grinding, quickly removes surface materials (paint/rust/...).



Equipped with QB-59642P39
6-hole Vacuum Pad



QB-59642P39

QB-58542

AIR 2-HAND RANDOM ORBITAL SANDER
Non-Vacuum 5mm orbit



6 pieces in one carton

- Low-speed, high-torque eccentric design for gravity grinding, quickly removes surface materials (paint/rust/...).



Equipped with QB-58642P39
Non-Vacuum Pad



5" QB-58542P39

QB-58642

AIR 2-HAND RANDOM ORBITAL SANDER
Non-Vacuum 5mm orbit



6 pieces in one carton

- Low-speed, high-torque eccentric design for gravity grinding, quickly removes surface materials (paint/rust/...).



Equipped with QB-58642P39
Non-Vacuum Pad



6" QB-58642P39

Item No.	Pad Dia	No Load Speed	Avg. Air Consumption	Air Pressure	Overall Length	Motor	Net Weight		Air Hose	Sound Pressure	Vibration Level	Orbit	Air Inlet
	inch(mm)	R.P.M	CFM (L/min)	PSI (bar)	Inch (mm)	HP	LBS	kg	Inch	dBA	m/s ²	mm	Inch
QB-57642	6"(152)	900	3.10(88)	90(6.3)	9-7/16"(240)	0.4	3.5	1.6	3/8"	82.0	<2.5	5	1/4"
QB-59642	6"(152)	900	3.10(88)	90(6.3)	9-7/16"(240)	0.4	3.5	1.6	3/8"	82.0	<2.5	5	1/4"
QB-58542	5"(127)	900	3.10(88)	90(6.3)	9-7/16"(240)	0.4	3.3	1.5	3/8"	82.0	<2.5	5	1/4"
QB-58642	6"(152)	900	3.10(88)	90(6.3)	9-7/16"(240)	0.4	3.5	1.6	3/8"	82.0	<2.5	5	1/4"

AIR SQUARE SANDER

QB-48012

AIR JITTERBUG SANDER
Non-Vacuum 2.5mm orbit



12 pieces in one carton

- Mirror-finish grinding effect, ideal for the final step in painting / coating / surface polishing.

Use with
VELCRO TYPE
Sanding Paper



QB-48111

AIR JITTERBUG SANDER
Non-Vacuum 2.5mm orbit



12 pieces in one carton

QB-48112

AIR JITTERBUG SANDER
Non-Vacuum 2.5mm orbit



12 pieces in one carton

- Mirror-finish grinding effect, ideal for the final step in painting / coating / surface polishing.

Use with
VELCRO TYPE
Sanding Paper



Sanding paper
mounted by **CLIP**



QB-48212

AIR JITTERBUG SANDER
Non-Vacuum 2.5mm orbit



12 pieces in one carton

- Mirror-finish grinding effect, ideal for the final step in painting / coating / surface polishing.

Use with
VELCRO TYPE
Sanding Paper



QB-48211

AIR JITTERBUG SANDER
Non-Vacuum 2.5mm orbit



5 pieces in one carton

Sanding paper
mounted by **CLIP**



Item No.	Pad Dia	No Load Speed	Avg. Air Consumption	Air Pressure	Overall Length	Motor	Net Weight		Air Hose	Sound Pressure	Vibration Level	Orbit	Air Inlet
	inch(mm)	R.P.M	CFM (L/min)	PSI (bar)	Inch (mm)	HP	LBS	kg	Inch	dBA	m/s ²	mm	Inch
QB-48012	3"x4"(75x100)	10000	5.0(141)	90(6.3)	5-3/8"(137)	0.24	1.8	0.8	3/8"	83.0	1.5	2.5	1/4"
QB-48111	4"x4-3/8"(100x110)	11000	7.0(198)	90(6.3)	5-1/5"(130)	0.28	2.0	0.9	3/8"	83.0	1.5	2.5	1/4"
QB-48112	4"x4-3/8"(100x110)	10000	5.0(141)	90(6.3)	5-3/8"(136)	0.24	1.7	0.8	3/8"	83.0	1.5	2.5	1/4"
QB-48211	2-1/2"x15-3/4"(64x100)	2100	5.0(141)	90(6.3)	17-1/2"(144)	0.24	6.1	2.8	3/8"	83.0	1.5	2.5	1/4"
QB-48212	7"x3-1/2"(93x180)	10000	5.0(141)	90(6.3)	7"(180)	0.24	2.0	0.9	3/8"	83.0	1.5	2.5	1/4"

AIR PISTOL POLISHER

AIR PISTOL POLISHER



QP-111 1" AIR ANGLE SANDER

10 pieces in one carton

- PAD provides spot eccentric sanding, avoiding 360° rotation.
- Vibration frequency up to 8000 RPM, suitable for mirror polishing.



QP-113 AIR PISTOL SANDER

2.5mm orbit



10 pieces in one carton



QP-123 AIR PISTOL POLISHER

10 pieces in one carton



10 pieces in one carton



QP-123QP AIR PISTOL POLISHER

10 pieces in one carton



- Air Pistol Sander, 3" Pad Dia
- QP-113: Air Pistol Sander, 3" Pad Dia
- QP-123: Air Pistol Polisher, 3" Pad Dia
- 1/4" Air Adaptor Couplings Male Thread Type
- 3" Sponge (Rough) & 3" Sponge (Medium)



QP-215 AIR HIGH SPEED SANDER

10 pieces in one carton



10 pieces in one carton



QP-307 S/M AIR ANGLE POLISHER

6 pieces in one carton



6 pieces in one carton



QP-327 S/M

AIR ANGLE POLISHER



6 pieces in one carton



QP-317

AIR ANGLE POLISHER



10 pieces in one carton



QP-335

VERTICAL POLISHER



10 pieces in one carton



Item No.	Pad Dia	Spindle Size	No Load Speed	Avg. Air Consumption	Air Pressure	Overall Length	Motor	Net Weight		Air Hose	Sound Pressure	Vibration Level	Orbit	Air Inlet
	inch(mm)		R.P.M	CFM (L/min)	PSI (bar)	Inch (mm)	HP	LBS	kg	Inch	dBA	m/s ²	mm	Inch
QP-111	1"(26)	M10xP1.5	8000	2.7(152)	90(6.3)	6-3/8"(162)	0.3	1.2	0.6	3/8"	89.0	0.3	---	1/4"
QP-113	3"(76)	5/16"-24	15000	3.5(99)	90(6.3)	5"(127)	0.40	1.5	0.7	3/8"	74.0	0.3	2.5	1/4"
QP-123	3"(76)	5/16"-24	2100	3.5(99)	90(6.3)	5-5/16"(135)	0.40	1.7	0.8	3/8"	74.0	0.21	---	1/4"
QP-215	5"(127)	7/16"-20	16000	6.5(184)	90(6.3)	6-19/64"(160)	0.80	2.6	1.2	3/8"	60.0	1.8	---	1/4"
QP-307(S/M)	7"(178)	5/8"-11(M14xP2)	4500	6.0(169)	90(6.3)	16"(406)	0.40	4.0	2.0	3/8"	84.0	2.5	---	1/4"
QP-317	7"(178)	5/8"-11	2500	6.0(169)	90(6.3)	16"(406)	0.40	4.0	2.0	3/8"	84.0	2.5	---	1/4"
QP-327(S/M)	7"(178)	5/8"-11(M14xP2)	2500	6.0(169)	90(6.3)	16"(406)	0.40	4.0	2.0	3/8"	84.0	2.5	---	1/4"
QP-335	5"(127)	5/16"-24	3000	3.65(103)	90(6.3)	8"(203)	0.55	1.1	0.5	3/8"	85.0	<2.5	---	1/4"

Air chamfering tools

QC-512

MINI AIR CHAMFERING TOOLS

10 pieces in one carton

- Extreme small size and light weight air tool.
- Also have variable chamfering speed function.
- Triangle type Indexable Inserts.



Triangle Indexable Inserts

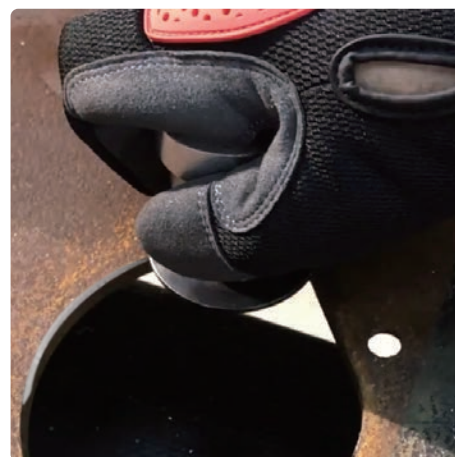

Item No.	Chamfering Capacity	No Load Speed	Avg. Air Consumption	Air Pressure	Overall Length	Net Weight		Air Hose	Sound Pressure
		R.P.M	CFM (L/min)	PSI (bar)	Inch (mm)	LBS	kg	Inch	dBA
QC-512	C0.1 - C2.0	28000	2	90(6.3)	4-1/7"(105)	1.1	0.5	3/8"	85

AIR CUTTING TOOLS

AIR CUTTING TOOLS



QC-213

3" HEAVY DUTY AIR CUT-OFF TOOL
Available Dimension of inner hold : Ø 3/8"



10 pieces in one carton

Note : Wheel is supplied with the tool



3" Wheel

QC-213T

3" HEAVY DUTY AIR CUT-OFF TOOL
Available Dimension of inner hold : Ø 3/8"



10 pieces in one carton

Note : Wheel is supplied with the tool



3" Wheel *Stylized grip*

QC-333

FLEX-HEAD AIR CUT-OFF TOOL



10 pieces in one carton

Note : Wheel is supplied with the tool

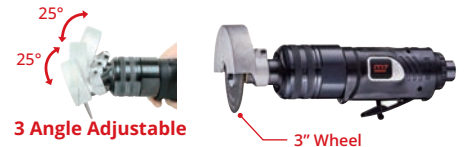

3 Angle Adjustable

3" Wheel

QC-234

4" HEAVY DUTY AIR CUT-OFF TOOL
Available Dimension of inner hold : Ø 10mm



10 pieces in one carton



4" Wheel

QC-234T

4" AIR CORNER CUT-OFF TOOL
Available Dimension of inner hold : Ø 10mm Ø 16mm



10 pieces in one carton

- Suitable for use in confined spaces.

Note : Wheel is supplied with the tool



4" Wheel *Stylized grip*

QC-264

4" AIR CORNER CUT-OFF TOOL
Available Dimension of inner hold : Ø 10mm Ø 16mm



10 pieces in one carton



4" Wheel *Stylized grip*

QC-253

3" AIR CUT-OFF TOOL



10 pieces in one carton

Note : Wheel is supplied with the tool



QC-254

4" AIR CORNER CUT-OFF TOOL
Available Dimension of inner hold : Ø 10mm



10 pieces in one carton

Note : Wheel is supplied with the tool



Item No.	Belt Size Pad Dia	No Load Speed	Avg. Air Consumption	Air Pressure	Overall Length	Motor	Net Weight		Air Hose	Sound Pressure	Vibration Level	Air Inlet
	inch(mm)	R.P.M	CFM (L/min)	PSI (bar)	Inch (mm)	HP	LBS	kg	Inch	dB(A)	m/s ²	Inch
QC-213	3"(75)	20000	10.0(283)	90(6.3)	7-7/8"(200)	0.9	1.9	0.9	3/8"	80.2	10.8	1/4"
QC-213T	3"(75)	22000	5.0(141)	90(6.3)	7-7/8"(200)	0.5	1.8	0.8	3/8"	85.0	3.0	1/4"
QC-234	4"(100)	16000	10.0(283)	90(6.3)	14"(355)	0.9	3.5	1.6	3/8"	85.0	5.0	1/4"
QC-234T	4"(100)	15000	5.0(141)	90(6.3)	13-9/16"(345)	0.5	3.1	1.4	3/8"	85.0	2.2	1/4"
QC-253	3"(75)	24000	4.0(113)	90(6.3)	8"(203)	0.6	1.7	0.8	3/8"	91.0	1.2	1/4"
QC-254	4"(100)	20000	5.0(141)	90(6.3)	8-1/8"(206)	0.6	2.0	0.9	3/8"	81.0	0.8	1/4"
QC-264	4"(100)	15000	5.0(141)	90(6.3)	9-5/32"(232)	0.5	2.4	1.1	3/8"	85.0	2.2	1/4"
QC-333	3"	20000	3.6(102)	90(6.3)	9-1/16"(230)	0.6	2.4	1.1	3/8"	88.0	3.0	1/4"

QD-221

AIR SAW WITH HOSE



10 pieces in one carton

5pcs 4.0mm file set included
1pc 32T saw blade included



QD-230

AIR MINI SAW WITH HOSE



10 pieces in one carton

4pcs 5.0mm file set included
1pc 32T saw blade included



QD-242

AIR FILE WITH HOSE



10 pieces in one carton

3pcs 5.0mm file set included
Note : The air mini saw is not supplied along with the tool



QD-260

AIR MINI SAW / FILE



20 pieces in one carton

- The length of this tool is very short.
- Note : The package contains a flat file and two saw blades



QD-291N

AIR SAW SET



10 pieces in one carton

Contents

- 1pc - Air saw tool (With 1pc 32T Saw Blade)
- 5pcs - 24T Saw Blade
- 5pcs - 32T Saw Blade
- 1pc - Allen Key : 4mm, 3mm
- 5pcs - 5.0 mm file set
- 1pc - Mini oiler 1/4"
- 1/4" 360° plug



QD-321

LOW VIBRATION AIR BODY SAW



15 pieces in one carton

- Extremely low vibration level.



QD-501

GEAR DRIVEN AIR SAW (3 in 1)



10 pieces in one carton

Note : The File is not supplied along with the tool.



QD-924P

24T Saw Blade Bi-Metal Material

10 pcs / box

Available with
QD-221 & QD-291



Blister+Card

QD-932P

32T Saw Blade Bi-Metal Material

10 pcs / box

Available with
QD-221 & QD-291

Blister+Card



Item No.	Strokes Length	Strokes Per min	Collet Size	Avg. Air Consumption	Air Pressure	Overall Length	Motor	Net Weight		Air Hose	Sound Pressure	Vibration Level	Air Inlet
	mm	S.P.M	mm	CFM (L/min)	PSI (bar)	Inch (mm)	HP	LBS	kg	Inch	dBA	m/s ²	Inch
QD-221	10	5000	4.0	4.0(113)	90(6.3)	9-3/4"(250)	---	1.8	0.8	3/8"	81.9	4.1	1/4"
QD-230	5	7000	5.0	2.5(70)	90(6.3)	7"(180)	---	1.1	0.5	3/8"	78.0	2.4	1/4"
QD-242	5	7000	5.0	5.3(150)	90(6.3)	17-9/16"(700)	---	1.3	0.6	3/8"	80.0	4.5	1/4"
QD-260	8	7000	6.0	4.5(127)	90(6.3)	6-11/16"(170)	0.3	1.0	0.6	3/8"	80.0	2.4	1/4"
QD-291	10	9000	5.0	4.0(113)	90(6.3)	9-1/4"(235)	---	1.3	0.6	3/8"	83.0	2.0	1/4"
QD-321	14.5	11000	5.0	4.0(113)	90(6.3)	9-1/4"(230)	---	1.7	0.5	3/8"	88.0	3.4	1/4"
QD-501	10	7000	5.0	4.5(127)	90(6.3)	11-5/8"(296)	0.5	2.6	1.2	3/8"	78.0	4.5	1/4"

AIR CUTTING TOOLS

AIR CUTTING TOOLS

IQG-102

AIR SHEAR Straight type



10 pieces in one carton



IQG-103

AIR NIBBLER



10 pieces in one carton



IQG-202

AIR SHEAR Pistol type



10 pieces in one carton



Item No.	Strokes Per min	Avg. Air Consumption	Air Pressure	Overall Length	Net Weight		Air Hose	Sound Pressure	Vibration Level	Cut Capacity		Air Inlet
	S.P.M	CFM (L/min)	PSI (bar)	Inch (mm)	LBS	kg	Inch	dba	m/s ²	mm	mm	Inch
QG-102	2600	6.0(170)	90(6.3)	10"(254)	2.2	1.0	3/8"	85.8	2.4	1.2	1.6	1/4"
QG-103	2600	3.0(85)	90(6.3)	7-3/5"(193)	2.2	1.0	3/8"	88.0	2.8	1.2	1.6	1/4"
QG-202	2600	6.5(184)	90(6.3)	8-1/4"(210)	2.4	1.1	3/8"	89.1	2.9	1.2	1.6	1/4"

IQK-111

AIR KNIFE



10 pieces in one carton



QK-111P08 QK-111P50 QK-111P51



QK-111P52 QK-111P53 QK-111P54



QK-2036 QK-2063 QK-2090



IQK-111T

AIR KNIFE



10 pieces in one carton



Stylized grip

IQK-121

AIR KNIFE



10 pieces in one carton



Pad

QB-9320



Air knife



Air Sander

IQK-131

AIR OSCILLATING TOOL WITH UNIVERSAL ADAPTER



20 pieces in one carton

Note : Blade is not supplied along with the tool



Patented flange can share pneumatic

Item No.	Oscillation	Avg. Air Consumption	Air Pressure	Overall Length	Net Weight		Air Hose	Sound Pressure	Vibration Level	Air Inlet
	per min	CFM (L/min)	PSI (bar)	Inch (mm)	LBS	kg	Inch	dba	m/s ²	Inch
QK-111	20000	6.0(170)	90(6.3)	7-5/64"(180)	2.4	1.1	3/8"	75	3.9	1/4"
QK-111T	20000	5.0(141)	90(6.3)	8-3/16"(208)	2.0	0.9	3/8"	85	3.3	1/4"
QK-121	19000	4.3(121)	90(6.3)	6-15/16"(176)	1.3	0.6	3/8"	91	2.8	1/4"
QK-131	20000	1.9(54)	90(6.3)	7-1/8"(180)	1.5	0.7	3/8"	78	4.5	1/4"

QK-112

AIR SCRAPER



10 pieces in one carton

- Removes gaskets, paint, rust and other materials.
- Removes undercoating, seam sealers, etc.
- Built-in regulator.



QK-112N

AIR SCRAPER KIT



10 pieces in one carton

Contains Blade



QK-112N

Blades included :

- QK-901 : 1" Wide Blade
- QK-902 : 1" Wide 45° Blade
- QK-903 : 1.75" L-Shaped Blade
- QK-904 : 1.77" Wide Blade



QK-901 1" QK-902 1" QK-903 1.75" QK-904 1.77"

Item No.	Strokes Length	Strokes Per min	Avg. Air Consumption	Air Pressure	Overall Length	Net Weight		Air Hose	Sound Pressure	Vibration Level	Air Inlet
	mm	S.P.M	CFM (L/min)	PSI (bar)	Inch (mm)	LBS	kg	Inch	dB(A)	m/s ²	Inch
QK-112	16	4200	3.0(84.9)	90(6.3)	7-23/32"(196)	1.5	0.7	3/8"	93.0	9.0	1/4"



PN-150

AIR PUNCH & FLANGE TOOL



10 pieces in one carton



PN-180

AIR PUNCH & FLANGE TOOL



10 pieces in one carton



PN-250

AIR PUNCH & FLANGE TOOL



10 pieces in one carton



PN-280

AIR PUNCH & FLANGE TOOL



10 pieces in one carton



Item No.	Punch Diameter	Capacity	Avg. Air Consumption	Air Pressure	Overall Length	Net Weight		Air Hose	Sound Pressure	Vibration Level	Air Inlet
	mm		CFM (L/min)	PSI (bar)	Inch (mm)	LBS	kg	Inch	dB(A)	m/s ²	Inch
PN-150	5	1.6mm(Steel)	4.0(113)	90(6.3)	10"(254)	2.5	1.2	3/8"	62.0	0.1	1/4"
PN-180	8	1.2mm(Steel)	4.0(113)	90(6.3)	10"(254)	2.5	1.2	3/8"	62.0	0.1	1/4"
PN-250	5	1.6mm(Steel)	4.0(113)	90(6.3)	7-15/32"(190)	2.6	1.2	3/8"	62.0	0.1	1/4"
PN-280	8	1.2mm(Steel)	4.0(113)	90(6.3)	7-15/32"(190)	2.6	1.2	3/8"	62.0	0.1	1/4"

AIR DRILL

AIR DRILL

PC-2010

ADJUSTABLE TORQUE AIR TAPPING TOOL



6 pieces in one carton



PC-901

ADJUSTABLE TORQUE AIR TAPPING ADAPTER HEX: 8mm

20 pieces in one carton

For: Air drill, electricity drill, cordless drill, drill machine



CAPACITY			
	steel	copper	aluminum
PC-2010	M3-M8	M3-M12	M3-M12
PC-901	M3-M6	M3-M8	M3-M8

Item No.	Capacity			No Load Speed	Stroke Length	Avg. Air Consumption	Air Pressure	Net Weight		Air Hose	Sound Pressure	Vibration Level	Air Inlet
	steel	copper	aluminum	R.P.M	inch(mm)	CFM (L/min)	PSI (bar)	LBS	kg	Inch	dBA	m/s ²	Inch
PC-2010													
	M3-M8	M3-M12	M3-M12	150	12"(305)	6.5(184)	90(6.3)	5.4	2.5	3/8"	82	1.5	1/4"

QE-231

SPOT DRILL & HOOK



6 pieces in one carton



FEATURES

- 8 mm drill bit included.
- 6.5,8,10 mm drill are available.
- Adjustable chuck for easy control.
- Hook is easily removed or installed.
- High quality piston improves torque and efficiency.
- Common applications are remove the surface of the solder joints and will not damage steel plate.
- Maximum drill depth : 4.5 mm, steel : 3.8 mm stainless.

Item No.	Chuck Size	No Load Speed	Motor	Overall Length	Avg. Air Consumption	Air Pressure	Net Weight		Air Hose	Sound Pressure	Vibration Level	Air Inlet
	inch(mm)	R.P.M	HP	inch(mm)	CFM (L/min)	PSI (bar)	LBS	kg	Inch	dBA	m/s ²	Inch
QE-231												
	5/16"(8)	1600	0.50	9-1/4"(235)	6.0(170)	90(6.3)	4.4	2.0	3/8"	88.2	0.1	1/4"

QE-2130

AIR REVERSIBLE DRILL



20 pieces in one carton



3500 RPM

QE-2133

AIR REVERSIBLE DRILL



10 pieces in one carton



2000 RPM

QE-2137

AIR REVERSIBLE DRILL



10 pieces in one carton



2800 RPM

QE-2143

AIR REVERSIBLE DRILL



20 pieces in one carton



500 RPM

Item No.	Chuck Size	No Load Speed	Motor	Overall Length	Avg. Air Consumption	Air Pressure	Net Weight		Air Hose	Sound Pressure	Vibration Level	Air Inlet
	inch(mm)	R.P.M	HP	inch(mm)	CFM (L/min)	PSI (bar)	LBS	kg	Inch	dBA	m/s ²	Inch
QE-2130												
QE-2133	3/8"(10)	2000	0.5(372w)	7-1/8"(181)	4(113)	90(6.3)	1.8	0.8	3/8"	92	0.2	1/4"
QE-2137	3/8"(10)	2800	0.5(372w)	7-1/8"(181)	4(113)	90(6.3)	1.8	0.8	3/8"	92	0.2	1/4"
QE-2143	1/2"(13)	500	0.5(372w)	9"(228)	4(113)	90(6.3)	2.6	1.2	3/8"	92	0.2	1/4"

QE-324

AIR DRILL

10 pieces in one carton



QE-331

3/8" AIR REVERSIBLE DRILL

With keyless chuck

10 pieces in one carton



3pcs Planet Gear

QE-332

3/8" AIR DRILL

With keyless chuck

10 pieces in one carton



3pcs Planet Gear

QE-333

3/8" AIR REVERSIBLE DRILL

With key chuck

10 pieces in one carton



3pcs Planet Gear

QE-334

3/8" AIR DRILL

With key chuck

10 pieces in one carton



3pcs Planet Gear

QE-431

3/8" AIR REVERSIBLE DRILL

With keyless chuck

10 pieces in one carton



2pcs Planet Gear with bearing

QE-432

3/8" AIR DRILL

With keyless chuck

10 pieces in one carton



2pcs Planet Gear with bearing

QE-433

3/8" AIR REVERSIBLE DRILL

With key chuck

10 pieces in one carton



2pcs Planet Gear with bearing

QE-434

3/8" AIR DRILL

With key chuck

10 pieces in one carton



2pcs Planet Gear with bearing

Item No.	Chuck Size	No Load Speed	Motor	Stall Torque	Overall Length	Avg. Air Consumption	Air Pressure	Net Weight		Air Hose	Sound Pressure	Vibration Level	Air Inlet
	inch(mm)	R.P.M	HP	N.m	inch(mm)	CFM (L/min)	PSI (bar)	LBS	kg	Inch	dBA	m/s ²	Inch
QE-324	1/4"(6.35)	5500	0.38	3.01	6-15/32"(164)	1.9(54)	90(6.3)	1.7	0.8	3/8"	74.0	1.2	1/4"
QE-331	3/8"(10)	1800	0.65	6.29	8"(203)	6.5(184)	90(6.3)	2.4	1.1	3/8"	96.5	0.3	1/4"
QE-332	3/8"(10)	2200	0.60	6.31	7-1/2"(190)	6.5(184)	90(6.3)	2.2	1.0	3/8"	96.5	0.3	1/4"
QE-333	3/8"(10)	1800	0.65	6.29	8"(203)	6.5(184)	90(6.3)	2.4	1.1	3/8"	92.0	0.2	1/4"
QE-334	3/8"(10)	2200	0.60	6.31	7-1/2"(190)	6.5(184)	90(6.3)	2.2	1.0	3/8"	92.0	0.2	1/4"
QE-431	3/8"(10)	1800	0.50	10.9	8-29/32"(226)	4.0(112)	90(6.3)	2.6	1.2	3/8"	90.0	3.0	1/4"
QE-432	3/8"(10)	2200	0.70	8.76	8-29/32"(226)	4.8(135)	90(6.3)	2.6	1.2	3/8"	90.0	3.0	1/4"
QE-433	3/8"(10)	1800	0.50	10.9	9-1/16"(230)	4.0(112)	90(6.3)	2.7	1.2	3/8"	90.0	3.0	1/4"
QE-434	3/8"(10)	2200	0.70	8.76	9-1/16"(230)	4.8(135)	90(6.3)	2.7	1.2	3/8"	90.0	3.0	1/4"

AIR DRILL

AIR DRILL

QE-532

3/8" AIR DRILL With keyless chuck



10 pieces in one carton



3pcs Planet Gear with bearing

QE-533

3/8" AIR REVERSIBLE DRILL

With key chuck



10 pieces in one carton



3pcs Planet Gear with bearing

QE-633

3/8" 90° AIR REVERSIBLE DRILL

With keyless chuck



10 pieces in one carton



2pcs Planet Gear with bearing

QE-634

3/8" 90° AIR ANGLE DRILL

With key chuck



QE-831

3/8" AIR REVERSIBLE DRILL

With keyless chuck



10 pieces in one carton



3pcs Planet Gear

QE-833

3/8" AIR REVERSIBLE DRILL

With key chuck



10 pieces in one carton



3pcs Planet Gear

QE-933

3/8" AIR REVERSIBLE DRILL

With keyless chuck



20 pieces in one carton



2pcs Planet Gear with bearing



QE-935

3/8" AIR STRAIGHT DRILL

With key chuck



10 pieces in one carton



Stylized grip

QE-936

3/8" AIR STRAIGHT DRILL

With key chuck



10 pieces in one carton



Stylized grip

Item No.	Chuck Size	No Load Speed	Motor	Stall Torque	Overall Length	Avg. Air Consumption	Air Pressure	Net Weight	Air Hose	Sound Pressure	Vibration Level	Air Inlet
	inch(mm)	R.P.M	HP	N.m	inch(mm)	CFM (L/min)	PSI (bar)	LBS kg	Inch	dBA	m/s ²	Inch
QE-532	3/8"(10)	2800	0.70	8.58	9-9/16"(243)	4.8(135)	90(6.3)	2.7 1.2	3/8"	90.0	3.0	1/4"
QE-533	3/8"(10)	2200	0.50	10.58	9-13/32"(189)	4.0(112)	90(6.3)	2.7 1.2	3/8"	90.0	3.0	1/4"
QE-633	3/8"(10)	1600	0.50	6.06	8-1/4"(210)	3.0(85)	90(6.3)	2.4 1.1	3/8"	72.0	2.5	1/4"
QE-634	3/8"(10)	1900	0.50	6.06	8-1/4"(211)	5(141)	90(6.3)	2.4 1.1	3/8"	85.0	1.1	1/4"
QE-831	3/8"(10)	1800	0.45	7.33	7-1/4"(185)	4.0(113)	90(6.3)	2.5 1.1	3/8"	83.0	0.3	1/4"
QE-833	3/8"(10)	1800	0.45	7.33	7-1/4"(185)	4.0(113)	90(6.3)	2.7 1.2	3/8"	83.0	0.3	1/4"
QE-933	3/8"(10)	2600	0.50	3.85	8-15/32"(215)	3.0(85)	90(6.3)	2.0 0.9	3/8"	72.0	2.5	1/4"
QE-935	3/8"(10)	4000	0.5	2.98	9"(230)	5.0(141)	90(6.3)	1.9 0.9	3/8"	85.0	1.6	1/4"
QE-936	3/8"(10)	22000	0.5	3.03	8-9/16"(218)	5.0(141)	90(6.3)	1.6 0.7	3/8"	85.0	1.2	1/4"



QE-341

1/2" AIR REVERSIBLE DRILL
With keyless chuck

★ ★ ★
10 pieces in one carton



3pcs Planet Gear x 2Set

QE-342

1/2" AIR DRILL With keyless chuck

★ ★ ★
10 pieces in one carton



3pcs Planet Gear x 2Set

QE-343

1/2" AIR REVERSIBLE DRILL
With key chuck

★ ★ ★
10 pieces in one carton



3pcs Planet Gear x 2Set

QE-344

1/2" AIR DRILL With key chuck

★ ★ ★
10 pieces in one carton



3pcs Planet Gear x 2Set

QE-441

1/2" AIR REVERSIBLE DRILL
With keyless chuck

★ ★ ★
10 pieces in one carton



2pcs Planet Gear x 2Set bearing

QE-442

1/2" AIR DRILL With keyless chuck

★ ★ ★
10 pieces in one carton



2pcs Planet Gear x 2Set bearing

Item No.	Chuck Size	No Load Speed	Motor	Stall Torque	Overall Length	Avg. Air Consumption	Air Pressure	Net Weight		Air Hose	Sound Pressure	Vibration Level	Air Inlet
	inch(mm)	R.P.M	HP	N.m	inch(mm)	CFM (L/min)	PSI (bar)	LBS	kg	Inch	dBA	m/s ²	Inch
QE-341	1/2"(13)	800	0.65	11.15	9"(230)	6.5(184)	90(6.3)	4.0	1.8	3/8"	96.5	0.1	1/4"
QE-342	1/2"(13)	800	0.60	11.03	8-1/4"(209)	6.5(184)	90(6.3)	3.7	1.7	3/8"	96.5	0.1	1/4"
QE-343	1/2"(13)	800	0.65	11.15	9"(230)	6.5(184)	90(6.3)	4.0	1.8	3/8"	97.5	0.1	1/4"
QE-344	1/2"(13)	800	0.60	11.03	8-1/4"(209)	6.5(184)	90(6.3)	3.7	1.7	3/8"	97.5	0.1	1/4"
QE-441	1/2"(13)	1100	0.50	14.68	10-5/8"(270)	4.0(112)	90(6.3)	3.5	1.6	3/8"	90.0	3.0	1/4"
QE-442	1/2"(13)	1300	0.70	13.54	10-5/8"(270)	4.8(135)	90(6.3)	3.5	1.6	3/8"	90.0	3.0	1/4"

AIR DRILL



AIR DRILL

QE-443

1/2" AIR REVERSIBLE DRILL
With key chuck



10 pieces in one carton



2pcs Planet Gear x 2Set bearing

QE-542

1/2" AIR DRILL With keyless chuck



10 pieces in one carton



3pcs Planet Gear x 2Set bearing

QE-543

1/2" AIR REVERSIBLE DRILL
With key chuck



10 pieces in one carton



3pcs Planet Gear x 2Set bearing

QE-841

1/2" AIR REVERSIBLE DRILL
With keyless chuck



10 pieces in one carton



3pcs Planet Gear x 2Set

QE-843

1/2" AIR REVERSIBLE DRILL
With key chuck



10 pieces in one carton



3pcs Planet Gear x 2Set

QE-845

1/2" AIR REVERSIBLE DRILL
With key chuck



10 pieces in one carton



3pcs Planet Gear x 2Set

Item No.	Chuck Size	No Load Speed	Motor	Stall Torque	Overall Length	Avg. Air Consumption	Air Pressure	Net Weight	Air Hose	Sound Pressure	Vibration Level	Air Inlet
	inch(mm)	R.P.M	HP	N.m	inch(mm)	CFM (L/min)	PSI (bar)	LBS kg	Inch	dBA	m/s ²	Inch
QE-443	1/2"(13)	1100	0.50	14.68	10-5/8"(270)	4.0(112)	90(6.3)	3.8 1.7	3/8"	90.0	3.0	1/4"
QE-542	1/2"(13)	1300	0.70	15.89	11"(280)	4.8(135)	90(6.3)	3.8 1.7	3/8"	90.0	3.0	1/4"
QE-543	1/2"(13)	1100	0.50	14.89	10-7/8"(276)	4.0(112)	90(6.3)	3.8 1.7	3/8"	90.0	3.0	1/4"
QE-841	1/2"(13)	800	0.45	12.58	8-1/4"(210)	4.0(113)	90(6.3)	3.7 1.7	3/8"	83.0	0.3	1/4"
QE-843	1/2"(13)	800	0.45	12.58	8-1/4"(210)	4.0(113)	90(6.3)	3.9 1.8	3/8"	83.0	0.3	1/4"
QE-845	1/2"(13)	500	0.45	12.83	8-1/4"(210)	4.0(113)	90(6.3)	3.9 1.8	3/8"	83.0	0.3	1/4"



QE-624
AIR DRILL

10 pieces in one carton



QE-624QA [SET]
4PCS MINI TOOLS SET

5 pieces in one carton

- QE-624
- QE-924
- QA-101
- QA-601



QE-924
AIR DRILL

10 pieces in one carton



Item No.	Chuck Size	No Load Speed	Motor	Overall Length	Avg. Air Consumption	Air Pressure	Net Weight		Air Hose	Sound Pressure	Vibration Level	Air Inlet
	inch(mm)	R.P.M	HP	inch(mm)	CFM (L/min)	PSI (bar)	LBS	kg	Inch	dBA	m/s ²	Inch
QE-624	1/4"(6)	5000	0.3	5-5/8"(143)	7.8(130)	90(6.3)	1.5	0.7	3/8"	82	1.2	1/4"
QE-924	1/4"(6)	6500	0.3	5-3/4"(146)	8.1(135)	90(6.3)	1.2	0.6	3/8"	77	1.2	1/4"
QA-101	1/4" & 1/8" (6 & 3)	25000	0.3	4-11/16"(119)	6.3(105)	90(6.3)	0.7	0.3	3/8"	80	1.4	1/4"
QA-601	1/4" & 1/8" (6 & 3)	22000	0.3	4-3/4"(120.7)	10(167)	90(6.3)	1.0	0.4	3/8"	84	1.1	1/4"

AIR DRILL



Aerospace-grade — suitable for aircraft exterior repair.

AIR DRILL

QE-6030

AIR RIGHT ANGLE DRILL
Threaded type



QE-6030L

AIR RIGHT ANGLE DRILL
Threaded type



QE-6130

AIR RIGHT ANGLE DRILL
Threaded type



QE-6130L

AIR RIGHT ANGLE DRILL
Threaded type



QE-6010

AIR 45° ANGLE DRILL
Threaded type



QE-6010L

AIR 45° ANGLE DRILL
Threaded type



QE-6020

AIR RIGHT ANGLE DRILL
Threaded type



QE-6020L

AIR RIGHT ANGLE DRILL
Threaded type



QE-6110

AIR 45° ANGLE DRILL
Threaded type



QE-6110L

AIR 45° ANGLE DRILL
Threaded type



QE-6120

AIR RIGHT ANGLE DRILL
Threaded type



QE-6120L

AIR RIGHT ANGLE DRILL
Threaded type



QE-6011

AIR 45° ANGLE DRILL
Collect type



QE-6011L

AIR 45° ANGLE DRILL
Collect type



QE-6021

AIR RIGHT ANGLE DRILL
Collect type



QE-6021L

AIR RIGHT ANGLE DRILL
Collect type



Item No.	Spindle Size	No Load Speed	Motor	Overall Length	Avg. Air Consumption	Air Pressure	Net Weight		Air Hose	Sound Pressure	Vibration Level	Air Inlet
	inch	R.P.M	HP	inch(mm)	CFM (L/min)	PSI (bar)	LBS	kg	Inch	dBA	m/s ²	kg/cm ²
QE-6010	1/4"-28	4000	0.40	10"(256)	3.0(84)	90(6.3)	1.4	0.6	3/8"	81.5	<2.5	1/4"
QE-6010L	1/4"-28	4000	0.40	13-1/8"(333)	3.0(84)	90(6.3)	1.7	0.8	3/8"	81.5	<2.5	1/4"
QE-6011	9/32"-40	4000	0.40	10"(256)	3.0(84)	90(6.3)	1.4	0.6	3/8"	81.5	<2.5	1/4"
QE-6011L	9/32"-40	4000	0.40	13-1/8"(333)	3.0(84)	90(6.3)	1.7	0.8	3/8"	81.5	<2.5	1/4"
QE-6020	1/4"-28	4000	0.40	9-1/2"(240)	3.0(84)	90(6.3)	1.4	0.6	3/8"	81.5	<2.5	1/4"
QE-6020L	1/4"-28	4000	0.40	12-1/8"(308)	3.0(84)	90(6.3)	1.7	0.8	3/8"	81.5	<2.5	1/4"
QE-6021	9/32"-40	4000	0.40	9-1/2"(240)	3.0(84)	90(6.3)	1.4	0.6	3/8"	81.5	<2.5	1/4"
QE-6021L	9/32"-40	4000	0.40	9-1/2"(240)	3.0(84)	90(6.3)	1.7	0.8	3/8"	81.5	<2.5	1/4"
QE-6030	1/4"-28	4000	0.40	9-1/2"(240)	3.0(84)	90(6.3)	1.4	0.6	3/8"	81.5	<2.5	1/4"
QE-6030L	1/4"-28	4000	0.40	12-1/8"(308)	3.0(84)	90(6.3)	1.7	0.8	3/8"	81.5	<2.5	1/4"
QE-6110	1/4"-28	3600	0.60	10-7/8"(274)	3.5(99)	90(6.3)	1.9	0.9	3/8"	82	<2.5	1/4"
QE-6110L	1/4"-28	3600	0.60	13-7/8"(351)	3.5(99)	90(6.3)	2.2	1.0	3/8"	82	<2.5	1/4"
QE-6120	1/4"-28	3600	0.60	10-1/4"(259)	3.5(99)	90(6.3)	1.9	0.9	3/8"	82	<2.5	1/4"
QE-6120L	1/4"-28	3600	0.60	12-7/8"(327)	3.5(99)	90(6.3)	2.2	1.0	3/8"	82	<2.5	1/4"
QE-6130	1/4"-28	3600	0.60	10-1/4"(259)	3.5(99)	90(6.3)	1.9	0.9	3/8"	82	<2.5	1/4"
QE-6130L	1/4"-28	3600	0.60	12-7/8"(327)	3.5(99)	90(6.3)	2.2	1.0	3/8"	82	<2.5	1/4"



Aerospace-grade —
suitable for aircraft exterior repair.

QE-6111
AIR 45° ANGLE DRILL
Collect type



QE-6111L
AIR 45° ANGLE DRILL
Collect type



QE-6121
AIR RIGHT ANGLE DRILL
Collect type



QE-6121L
AIR RIGHT ANGLE DRILL
Collect type



Item No.	Spindle Size	No Load Speed	Motor	Overall Length	Avg. Air Consumption	Air Pressure	Net Weight		Air Hose	Sound Pressure	Vibration Level	Air Inlet
	inch	R.P.M	HP	inch(mm)	CFM (L/min)	PSI (bar)	LBS	kg	Inch	dBA	m/s ²	kg/cm ²
QE-6111	9/32"-40	3600	0.60	10-7/8"(274)	3.5(99)	90(6.3)	1.9	0.9	3/8"	82	<2.5	1/4"
QE-6111L	9/32"-40	3600	0.60	13-7/8"(351)	3.5(99)	90(6.3)	2.2	1.0	3/8"	82	<2.5	1/4"
QE-6121	9/32"-40	3600	0.60	10-1/4"(259)	3.5(99)	90(6.3)	1.9	0.9	3/8"	82	<2.5	1/4"
QE-6121L	9/32"-40	3600	0.60	12-7/8"(327)	3.5(99)	90(6.3)	2.2	1.0	3/8"	82	<2.5	1/4"

QE-6012
AIR 45° ANGLE DRILL
Chuck type



QE-6012L
AIR 45° ANGLE DRILL
Chuck type



QE-6022
AIR RIGHT ANGLE DRILL
Chuck type



QE-6022L
AIR RIGHT ANGLE DRILL
Chuck type



QE-6112
AIR 45° ANGLE DRILL
Chuck type



QE-6112L
AIR 45° ANGLE DRILL
Chuck type



QE-6122
AIR RIGHT ANGLE DRILL
Chuck type



QE-6122L
AIR RIGHT ANGLE DRILL
Chuck type



Item No.	Chuck Size	No Load Speed	Motor	Overall Length	Avg. Air Consumption	Air Pressure	Net Weight		Air Hose	Sound Pressure	Vibration Level	Air Inlet
	inch(mm)	R.P.M	HP	inch(mm)	CFM (L/min)	PSI (bar)	LBS	kg	Inch	dBA	m/s ²	kg/cm ²
QE-6012	1/8"(3)	4000	0.40	10-1/8"(256)	3.0(84)	90(6.3)	1.4	0.6	3/8"	81.5	<2.5	1/4"
QE-6012L	1/8"(3)	4000	0.40	10-1/4"(333)	3.0(84)	90(6.3)	1.7	0.8	3/8"	81.5	<2.5	1/4"
QE-6022	1/8"(3)	4000	0.40	9-1/2"(240)	3.0(84)	90(6.3)	1.4	0.6	3/8"	81.5	<2.5	1/4"
QE-6022L	1/8"(3)	4000	0.40	12-1/8"(308)	3.0(84)	90(6.3)	1.7	0.8	3/8"	81.5	<2.5	1/4"
QE-6112	1/8"(3)	3600	0.60	10-3/4"(274)	3.5(99)	90(6.3)	1.9	0.9	3/8"	82	<2.5	1/4"
QE-6112L	1/8"(3)	3600	0.60	13-7/8"(351)	3.5(99)	90(6.3)	2.2	1.0	3/8"	82	<2.5	1/4"
QE-6122	1/8"(3)	3600	0.60	10-1/4"(259)	3.5(99)	90(6.3)	1.9	0.9	3/8"	82	<2.5	1/4"
QE-6122L	1/8"(3)	3600	0.60	12-7/8"(327)	3.5(99)	90(6.3)	2.2	1.0	3/8"	82	<2.5	1/4"

AIR DRILL

AIR SCREWDRIVER



Pistol Type

★★
Excellent

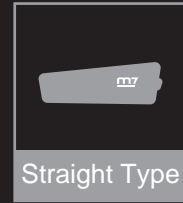

Straight Type

★
Good

AIR SCREWDRIVER

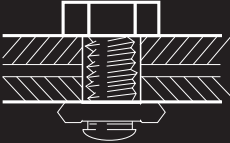
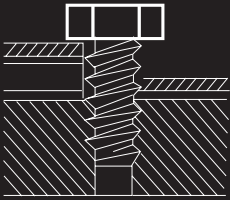
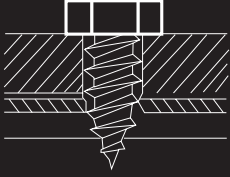
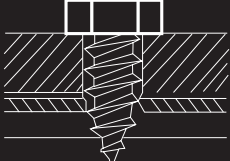
Joint & Torque Curve	Clutch Type	Model Number						
		M3	M3.5	M4	M5	M6	M8	
 <p>Free Running Hard stop/soft stop</p>	★★ Shut-off Screwdriver	RA-3023	RA-3017	RA-3011	RA-4008			
			RA-3123	RA-4015	RA-5005			
				RA-4021	RA-5008			
				RA-5017	RA-4108			
				RA-3111	RA-4115			
				RA-3117	RA-5015			
				RA-4121	RA-5108			
					RA-5117			
					RA-1131	RA-1151	RA-802	
					RA-1132	RA-2161	RA-302	
 <p>Self-Tapping Thick Material Sheet Metal</p>	★★ Adjustable Clutch			RA-1131	RA-1151	RA-802		
				RA-1132	RA-2161	RA-302		
				RA-1141				
				RA-1142				
				RA-1162				
				RA-301				
				RA-801				
				RA-1232	RA-2242	RA-606	RA-2272	
				RA-1242	RA-102	RA-201	RA-608	
				RA-101			RA-1272	
 <p>Self-Tapping Plastic</p>	★★ Adjustable Clutch			RA-1131	RA-1151	RA-802		
				RA-1132	RA-2161	RA-302		
				RA-1141				
				RA-1142				
				RA-1162				
				RA-301				
				RA-801				
				RA-1232	RA-2242	RA-606	RA-2272	
				RA-1242	RA-102	RA-201	RA-608	
				RA-101		RA-105	RA-1272	
 <p>Wood screws</p>	★★ Positive Clutch				RA-811			
					RA-402			
				RA-1232	RA-2242	RA-606	RA-2272	
	★ Twin Dog			RA-1242	RA-102	RA-201	RA-608	
				RA-101		RA-105	RA-1272	
				RA-101C				

Clutch Type Series

Extmal Adjament

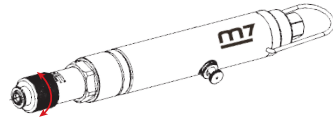

RA-1131

AIR SCREWDRIVER ADJUSTABLE CLUTCH
Screw capacity : M4



10 pieces in one carton



RA-1141

AIR SCREWDRIVER ADJUSTABLE CLUTCH
Screw capacity : M4



10 pieces in one carton



RA-1151

AIR SCREWDRIVER ADJUSTABLE CLUTCH
Screw capacity : M5



10 pieces in one carton



RA-2161

AIR SCREWDRIVER ADJUSTABLE CLUTCH
Screw capacity : M5



10 pieces in one carton

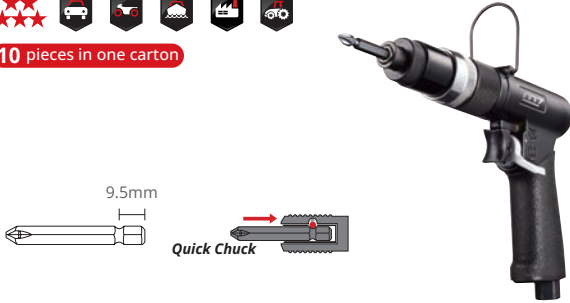

RA-801ET

AIR SCREWDRIVER EXTERNAL ADJUSTABLE
Screw capacity : M4



10 pieces in one carton

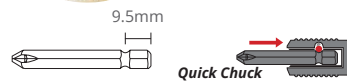

Impact Type Series

Twin Dog Type



RA-101

Twin dog type
Screw capacity : M4



20 pieces in one carton



RA-101C

Twin dog type
Screw capacity : M4



20 pieces in one carton

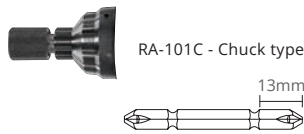

RA-102

Twin dog type
Screw capacity : M5



20 pieces in one carton



RA-105

Twin dog type
Screw capacity : M6



12 pieces in one carton

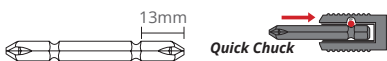

RA-1232

Twin dog type
Screw capacity : M4



10 pieces in one carton



RA-1242

Twin dog type
Screw capacity : M4



10 pieces in one carton

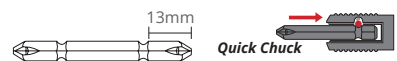

AIR SCREWDRIVER

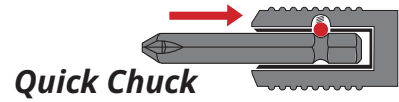

RA-1272

Twin dog type
Screw capacity : M8



10 pieces in one carton



RA-608

Twin dog type
Screw capacity : M8



12 pieces in one carton



RA-201

Twin dog type
Screw capacity : M8



8 pieces in one carton



RA-606

Twin dog type
Screw capacity : M6



12 pieces in one carton



RA-2242

Twin dog type
Screw capacity : M5



10 pieces in one carton



RA-2272

Twin dog type
Screw capacity : M8



10 pieces in one carton



AIR SCREWDRIVER

Item No.	Bit Size	Torque Range	No Load Speed	Overall Length	Avg. Air Consumption	Air Pressure	Net Weight		Air Hose	Sound Pressure	Vibration Level	Air Inlet
	inch(mm)	ft-lb(Nm)	R.P.M	inch(mm)	CFM (L/min)	PSI (bar)	LBS	kg	Inch	dBA	m/s ²	Inch
RA-1131	1/4"(6.35)	0.7-2.9(1-4)	1800	9"(228)	4.5(127)	90(6.3)	1.6	0.8	3/8"	80.0	2.3	1/4"
RA-1141	1/4"(6.35)	0.7-2.2(1-3)	800	8-7/8"(226)	4.5(127)	90(6.3)	1.6	0.8	3/8"	80.0	2.3	1/4"
RA-1151	1/4"(6.35)	1.4-3.7(2-5)	1900	9-1/32"(229)	4.5(127)	90(6.3)	2.2	1.0	3/8"	85.0	2.3	1/4"
RA-2161	1/4"(6.35)	1.4-3.7(2-5)	750	7-15/32"(190)	7.5(212)	90(6.3)	2.0	1.0	3/8"	80.0	2.0	1/4"
RA-801ET	1/4"(6.35)	3.8-10.4(5-14)	1700	7-4/5"(198)	17.5(496)	90(6.3)	2.7	1.2	1/4"	93.6	1.35	1/4"
RA-101	1/4"(6.35)	3.7-8.9(5-12)	9000	6-1/2"(166)	6.0(170)	90(6.3)	1.3	0.6	3/8"	85.7	2.2	1/4"
RA-102	1/4"(6.35)	3.7-10.3(5-14)	9000	6-3/4"(172)	6.0(170)	90(6.3)	1.5	0.7	3/8"	86.7	3.7	1/4"
RA-105	1/4"(6.35)	3.7-16.2(5-22)	8500	8-1/4"(208)	8.5(241)	90(6.3)	2.2	1.0	3/8"	96.7	4.9	1/4"
RA-1232	1/4"(6.35)	11-22(15-30)	9000	7-11/16"(195)	4.5(127)	90(6.3)	1.5	0.7	3/8"	80.0	3.2	1/4"
RA-1242	1/4"(6.35)	14-22(19-30)	12500	6-11/16"(170)	5.0(141)	90(6.3)	1.3	0.6	3/8"	89.0	3.9	1/4"
RA-1272	1/4"(6.35)	44-177(60-240)	8000	7-27/32"(200)	9.0(255)	90(6.3)	2.3	1.1	3/8"	97.0	5.1	1/4"
RA-201	1/4"(6.35)	3.7-18.5(5-25)	10000	7"(180)	9.0(255)	90(6.3)	2.7	1.2	3/8"	93.0	5.3	1/4"
RA-606	1/4"(6.35)	3.7-33.2(5-45)	8000	7-4/5"(198)	5.6(160)	90(6.3)	2.2	1.0	3/8"	82.0	2.2	1/4"
RA-608	1/4"(6.35)	3.7-42.8(5-58)	8000	8-9/16"(217)	4.6(130)	90(6.3)	2.9	1.3	3/8"	86.0	3.5	1/4"
RA-2242	1/4"(6.35)	18-26(24.4-35.2)	13000	5-15/16"(150)	7.0(198)	90(6.3)	2.0	0.9	3/8"	88.0	2.7	1/4"
RA-2272	1/4"(6.35)	44-177(59-240)	7700	7-11/16"(195)	8.5(240)	90(6.3)	3.0	1.4	3/8"	93.0	4.9	1/4"

Clutch Type Series

Internal Adjustment

Quick Chuck



RA-1132

ADJUSTABLE CLUTCH

Screw capacity : M4



10 pieces in one carton

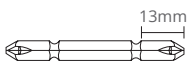

RA-1142

ADJUSTABLE CLUTCH

Screw capacity : M4



10 pieces in one carton

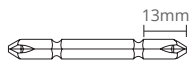

RA-1162

ADJUSTABLE CLUTCH

Screw capacity : M6



10 pieces in one carton

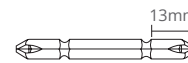

RA-301

ADJUSTABLE CLUTCH

Screw capacity : M4



10 pieces in one carton



Quick Chuck

RA-302

ADJUSTABLE CLUTCH

Screw capacity : M6



10 pieces in one carton

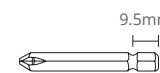

Quick Chuck

RA-801

ADJUSTABLE CLUTCH

Screw capacity : M4



10 pieces in one carton



Quick Chuck

RA-802

ADJUSTABLE CLUTCH

Screw capacity : M6



10 pieces in one carton

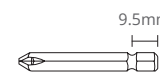

Quick Chuck

Item No.	Bit Size	Torque Range	No Load Speed	Overall Length	Avg. Air Consumption	Air Pressure	Net Weight		Air Hose	Sound Pressure	Vibration Level	Air Inlet
	inch(mm)	ft-lb(Nm)	R.P.M	inch(mm)	CFM (L/min)	PSI (bar)	LBS	kg	Inch	dB(A)	m/s ²	Inch
RA-1132	1/4"(6.35)	0.7-2.2(1-3)	2200	9-7/32"(235)	6.0(170)	90(6.3)	1.7	0.8	3/8"	80.0	2.3	1/4"
RA-1142	1/4"(6.35)	0.7-2.2(1-3)	1700	9-7/32"(235)	5.0(141)	90(6.3)	1.3	0.6	3/8"	80.0	2.0	1/4"
RA-1162	1/4"(6.35)	1.5-5.9(2-8)	600	10-7/16"(265)	6.0(170)	90(6.3)	2.1	1.0	3/8"	90.0	2.2	1/4"
RA-301	1/4"(6.35)	3.8-10(5-13.5)	1800	7-1/2"(190)	6.0(170)	90(6.3)	2.4	1.1	3/8"	95.3	4.2	1/4"
RA-302	1/4"(6.35)	3.8-12(5-16.3)	800	9"(226)	6.0(170)	90(6.3)	2.9	1.3	3/8"	96.5	2.2	1/4"
RA-801	1/4"(6.35)	3.8-10.4(5-14)	1800	7-3/4"(195)	4.0(113)	90(6.3)	2.7	1.2	3/8"	83.0	4.2	1/4"
RA-802	1/4"(6.35)	3.8-13.3(5-18)	800	8-9/32"(210)	4.0(113)	90(6.3)	2.8	1.3	3/8"	83.0	4.2	1/4"

AIR SCREWDRIVER

AIR SCREWDRIVER

Positive Clutch Type Non - Adjustable

RA-402

POSITIVE CLUTCH TYPE

Screw capacity : M6



10 pieces in one carton

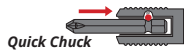
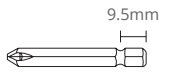

RA-811

POSITIVE CLUTCH TYPE

Screw capacity : M6



10 pieces in one carton

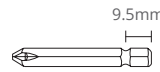

Torque Control or Shut-off

RA-31/RA-41/RA-51 SERIES

SHUT-OFF SCREWDRIVER



12 pieces in one carton

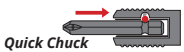

RA-30/RA-40/RA-50 SERIES

SHUT-OFF SCREWDRIVER



12 pieces in one carton

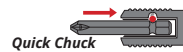
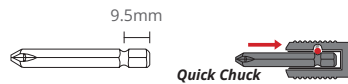

ZT-31

DIGITAL TORQUE TESTER

Torque range 0-14.7Nm

1 pieces in one carton



AIR SCREWDRIVER

Item No.	Bit Size	Torque Range	No Load Speed	Overall Length	Avg. Air Consumption	Air Pressure	Net Weight		Air Hose	Sound Pressure	Vibration Level	Air Inlet
	inch(mm)	ft-lb(Nm)	R.P.M	inch(mm)	CFM (L/min)	PSI (bar)	LBS	kg	Inch	dB(A)	m/s ²	Inch
RA-402	1/4"(6.35)	5-14(6-19)	2200	7-3/32"(180)	3.9(111)	90(6.3)	2.5	1.1	3/8"	91.0	2.3	1/4"
RA-811	1/4"(6.35)	5.0-13.0(6-17)	2100	7"(178)	4.0(113)	90(6.3)	2.5	1.1	3/8"	83.0	3.7	1/4"
RA-3011	1/4"(6.35)	9.7-18.6(1.1-2.1)	1100	7-3/8"(187)	3.2(90.6)	90(6.3)	0.9	0.4	1/4"	70.0	2.0	1/4"
RA-3017	1/4"(6.35)	6.2-13.3(0.7-1.5)	1700	7-3/8"(187)	3.2(90.6)	90(6.3)	0.9	0.4	1/4"	70.0	2.0	1/4"
RA-3023	1/4"(6.35)	3.5-8.8(0.4-1.0)	2300	7-3/8"(187)	3.2(90.6)	90(6.3)	0.9	0.4	1/4"	70.0	2.0	1/4"
RA-4008	1/4"(6.35)	14.1-35.4(1.6-4.0)	800	8-1/4"(209)	3.7(104.8)	90(6.3)	1.4	0.7	1/4"	74.0	2.5	1/4"
RA-4015	1/4"(6.35)	8.8-19.5(1.0-2.2)	1500	8-1/4"(209)	3.7(104.8)	90(6.3)	1.4	0.7	1/4"	74.0	2.5	1/4"
RA-4021	1/4"(6.35)	8.8-15(1.0-1.7)	2100	8-1/4"(209)	3.7(104.8)	90(6.3)	1.4	0.7	1/4"	74.0	2.5	1/4"
RA-5005	1/4"(6.35)	44.2-92.9(5.0-10.5)	480	9-1/2"(240)	4.0(113)	90(6.3)	2.2	1.0	3/8"	75.0	10	1/4"
RA-5008	1/4"(6.35)	26.5-48.7(3.0-5.5)	800	9-1/2"(240)	4.0(113)	90(6.3)	2.2	1.0	3/8"	75.0	10	1/4"
RA-5017	1/4"(6.35)	13.3-23.0(1.5-2.6)	1700	9-1/2"(240)	4.0(113)	90(6.3)	2.2	1.0	3/8"	75.0	10	1/4"
RA-3111	7/64"(2.6)	9.7-18.5(1.1-2.1)	1100	6-11/16"(170)	7.0(198)	90(6.3)	1.6	0.7	1/4"	82.0	0.73	1/4"
RA-3117	1/4"(6.35)	6.2-13.2(0.7-1.5)	1700	6-11/16"(170)	7.0(198)	90(6.3)	1.6	0.7	1/4"	84.0	1.51	1/4"
RA-3123	1/4"(6.35)	3.5-8.8(0.4-1.0)	2300	6-11/16"(170)	7.0(198)	90(6.3)	1.6	0.7	1/4"	84.0	1.34	1/4"
RA-4108	1/4"(6.35)	14.1-35.2(1.6-4.0)	800	6-15/16"(175)	10.5(297)	90(6.3)	1.9	0.9	1/4"	87.5	1.18	1/4"
RA-4115	1/4"(6.35)	8.8-19.4(1.0-2.2)	1500	6-15/16"(175)	10.5(297)	90(6.3)	1.9	0.9	1/4"	85.5	1.59	1/4"
RA-4121	1/4"(6.35)	8.8-13.2(1.0-1.7)	2100	6-15/16"(175)	10.5(297)	90(6.3)	1.9	0.9	1/4"	86.8	1.61	1/4"
RA-5105	1/4"(6.35)	44-92.4(5.0-10.5)	480	7-4/5"(198)	17.5(496)	90(6.3)	2.7	1.2	1/4"	93.1	0.48	1/4"
RA-5108	1/4"(6.35)	26.4-48.4(3.0-5.5)	800	7-4/5"(198)	17.5(496)	90(6.3)	2.7	1.2	1/4"	93.6	0.93	1/4"
RA-5117	1/4"(6.35)	13.2-23(1.5-2.6)	1700	7-4/5"(198)	17.5(496)	90(6.3)	2.7	1.2	1/4"	93.6	1.35	1/4"

SPRING BALANCER

SP-3400 SP-3500

2 pieces in one carton



SP-3600 SP-3700 SP-3900 SP-31050 SP-31200

2 pieces in one carton

SP-3600/SP-3700

1 pieces in one carton

SP-3900/SP-31050/SP-31200



SP-3030/SP-3050 SP-3070/SP-3090 SP-3150/SP-3220 SP-3300

10 pieces in one carton

SP-3030/SP-3050/SP-3070

4 pieces in one carton

SP-3090/SP-3150

2 pieces in one carton

SP-3220/SP-3300



SP-101/SP-102 SP-103/SP-104 SP-105/SP-111 SP-112/SP-113

30 pieces in one carton



SP-212 SP-213

30 pieces in one carton



Item No.	Capacity	Travel	Rope	Rope Dia	Weight
	kg	m		mm	kg
SP-3400	30-40	1.5	Cable	4.8	9.7
SP-3500	40-50	1.5	Cable	4.8	10.1
SP-3600	50-60	1.5	Cable	4.8	11.1
SP-3700	60-70	1.5	Cable	4.8	11.4
SP-3900	70-90	2	Cable	4.8	22.2
SP-31050	90-105	2	Cable	4.8	23.8
SP-31200	105-120	2	Cable	4.8	27.4
SP-3030	1.5-3.0	1.3	Cable	3.2	1.7
SP-3050	3.0-5.0	1.3	Cable	3.2	1.8
SP-3070	5.0-7.0	1.3	Cable	3.0	1.9
SP-3090	5.0-9.0	1.3	Cable	4.0	3.6
SP-3150	9.0-15.0	1.3	Cable	4.0	3.6
SP-3220	15.0-22.0	1.3	Cable	4.8	7.7
SP-3300	22.0-30.0	1.3	Cable	4.8	8.3
SP-101	0.3-0.8	1.4	Cable	2.5	0.5
SP-102	0.6-1.5	1.4	Cable	2.5	0.5
SP-103	1.0-2.0	1.4	Cable	2.5	0.5
SP-104	1.5-3.0	1.4	Cable	3.2	0.8
SP-105	3.0-5.0	1.4	Cable	3.2	0.8
SP-111	0.3-0.8	1.4	Nylon	4.0	0.5
SP-112	0.6-1.5	1.4	Nylon	4.0	0.5
SP-113	1.0-2.0	1.4	Nylon	4.0	0.5
SP-212	0.3-1.2	1.4	Nylon	4.0	0.6
SP-213	0.8-2.0	1.4	Nylon	4.0	0.6

AIR HAMMER

AIR HAMMER

SC-211C ● AIR HAMMER ROUND SHANK



• SC-4 chisel kit is provided along with the tool.



SC-221C ◆ AIR HAMMER HEX SHANK



• SC-4 chisel kit is provided along with the tool.



SC-212C ● AIR HAMMER ROUND SHANK



• SC-4 chisel kit is provided along with the tool.



SC-222C ◆ AIR HAMMER HEX SHANK



• SC-4 chisel kit is provided along with the tool.



SC-331C ● AIR HAMMER ROUND SHANK LOW VIBRATION AIR HAMMER



• Extremely low vibration level.
• SC-4 chisel kit is provided along with the tool.



SC-341C ◆ AIR HAMMER HEX SHANK LOW VIBRATION AIR HAMMER



• Extremely low vibration level.
• SC-4 chisel kit is provided along with the tool.



SC-332C ● AIR HAMMER ROUND SHANK LOW VIBRATION AIR HAMMER



• SC-4 chisel kit is provided along with the tool.



SC-342C ◆ AIR HAMMER HEX SHANK LOW VIBRATION AIR HAMMER



• SC-4 chisel kit is provided along with the tool.



SC-371 ● AIR HAMMER



• Do not include the chisel



SC-371C ● AIR HAMMER



• Include the chisel



HAMMER CHISEL



Item No.	Shank	Chunk Size	Stroke Length	Blow Minute	Avg. Air Consumption	Air Pressure	Overall Length	Net Weight		Air Hose	Sound Pressure	Vibration Level	Air Inlet
	● ◆ ■	inch(mm)	mm	b.p.m	CFM (L/min)	PSI (bar)	inch(mm)	LBS	kg	Inch	dBA	m/s ²	Inch
SC-211C	●	3/8"(10.2)	67	3200	4.0(113)	90(6.3)	6-7/8"(175)	3.7	1.7	3/8"	98.0	12.3	1/4"
SC-221C	◆	3/8"(10)	67	3200	4.0(113)	90(6.3)	6-7/8"(175)	3.7	1.7	3/8"	98.0	12.3	1/4"
SC-212C	●	3/8"(10.2)	89	2200	4.0(113)	90(6.3)	8-7/8"(225)	4.4	2.0	3/8"	94.7	13.2	1/4"
SC-222C	◆	3/8"(10)	89	2200	4.0(113)	90(6.3)	8-7/8"(225)	4.4	2.0	3/8"	94.7	13.2	1/4"
SC-331C	●	3/8"(10.2)	71	3000	7.8(220)	90(6.3)	7-31/64"(190)	3.7	1.7	1/4"	92.0	9.5	1/4"
SC-332C	●	3/8"(10.2)	92	2200	8.2(232)	90(6.3)	8-63/64"(228)	4.4	2.0	3/8"	94.0	10.6	1/4"
SC-341C	◆	3/8"(10)	71	3000	7.8(190)	90(6.3)	7-31/64"(190)	3.7	1.7	3/8"	92.0	9.5	1/4"
SC-342C	◆	3/8"(10)	92	2200	8.2(232)	90(6.3)	8-63/64"(228)	4.4	2.0	3/8"	94.0	10.6	1/4"
SC-371	●	3/8"(10.2)	62.5	3000	7.8(180)	90(6.3)	7-1/8"(180)	3.7	1.7	3/8"	95.0	8.8	1/4"



SN-1032

AIR FLUX CHIPPER



12 pieces in one carton

- Include the chisel



SC-05C[SET]

5 pieces in one carton

- 1pc- Air Hammer (Various Selections)
- 5pcs-Chisel Kits
- 1pc- Spring Retainer



Item No.	Shank	Contents
SC-0517C	Round Shank	SC-211C
SC-0527C	Round Shank	SC-212C

SC-06C[SET]

5 pieces in one carton

- 1pc- Air Hammer (Various Selections)
- 5pcs-Chisel Kits
- 1pc- Spring Retainer



Item No.	Shank	Contents
SC-0617C	Hex Shank	SC-221C
SC-0627C	Hex Shank	SC-222C

SC-33C

NEEDLE SCALER ADAPTOR

FOR AIR HAMMER TOOLS USE ROUND/HEX
19pcs Ø 3 mm x 180 mm

20 pieces in one carton

- SC-33C - / Round Shank



SC-34C

NEEDLE SCALER ADAPTOR

FOR AIR HAMMER TOOLS USE ROUND/HEX
19pcs Ø 3 mm x 180 mm

20 pieces in one carton

- SC-34C - / Hex Shank



SN-9101

CHISEL FOR SN-31/SN-32 SERIES

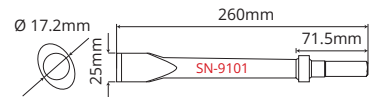

SN-9103

CHISEL FOR SN-31/SN-32 SERIES

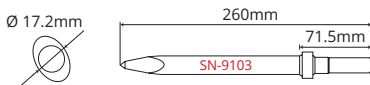

SN-9201

CHISEL FOR SN-31/SN-32 SERIES

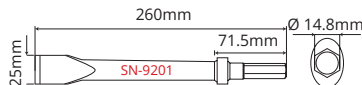

SN-9203

CHISEL FOR SN-31/SN-32 SERIES

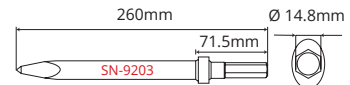

Item No.	Shank	Chunk Size	Stroke Length	Blow Minute	Avg. Air Consumption	Air Pressure	Overall Length	Net Weight		Air Hose	Sound Pressure	Vibration Level	Air Inlet
		inch(mm)	mm	b.p.m	CFM (L/min)	PSI (bar)	inch(mm)	LBS	kg	Inch	dBA	m/s ²	Inch
SN-1032		0.51(13)	33	4000	4.23(120)	90(6.3)	11-1/2"(290)	2.9	1.3	3/8"	91.0	14.5	1/4"

AIR HAMMER

AIR HAMMER

SN-3111C ROUND SHANK



2 pieces in one carton
• include the chisel



SN-3112C ROUND SHANK



2 pieces in one carton
• include the chisel



SN-3113C ROUND SHANK



2 pieces in one carton
• include the chisel



SN-3114C ROUND SHANK



2 pieces in one carton
• include the chisel



SN-3121C HEX SHANK



2 pieces in one carton
• include the chisel



SN-3122C HEX SHANK



2 pieces in one carton
• include the chisel



SN-3123C HEX SHANK



2 pieces in one carton
• include the chisel



SN-3124C HEX SHANK



2 pieces in one carton
• include the chisel



SN-3212C ROUND SHANK



2 pieces in one carton
• include the chisel



SN-3213C ROUND SHANK



2 pieces in one carton
• include the chisel



SN-3214C ROUND SHANK



2 pieces in one carton
• include the chisel



SN-3222C HEX SHANK



2 pieces in one carton
• include the chisel



SN-3223C HEX SHANK



2 pieces in one carton
• include the chisel

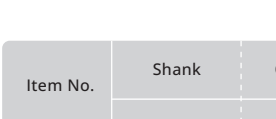

SN-3224C HEX SHANK



2 pieces in one carton
• include the chisel

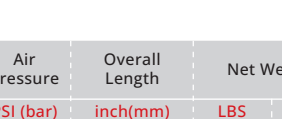

SN-3224C HEX SHANK



2 pieces in one carton
• include the chisel

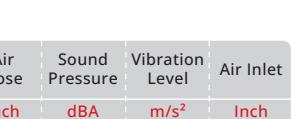

Item No.	Shank	Chunk Size	Stroke Length	Blow Minute	Avg. Air Consumption	Air Pressure	Overall Length	Net Weight		Air Hose	Sound Pressure	Vibration Level	Air Inlet
								LBS	kg				
		inch(mm)	mm	b.p.m	CFM (L/min)	PSI (bar)	inch(mm)	lb	kg	Inch	dBA	m/s ²	Inch
SN-3111C	●	0.68(17.2)	75	2500	10.0(283)	90(6.3)	15-1/2"(395)	15.4	7.0	1/2"	115.3	8.0	1/2"
SN-3121C	●	0.58(14.8)	75	2500	10.0(283)	90(6.3)	15-1/2"(395)	15.4	7.0	1/2"	115.3	8.0	1/2"
SN-3112C	●	0.68(17.2)	90	2300	20.0(566)	90(6.3)	16"(405)	16.1	7.3	1/2"	114.3	9.4	1/2"
SN-3122C	●	0.58(14.8)	90	2300	20.0(566)	90(6.3)	16"(405)	16.1	7.3	1/2"	114.3	9.4	1/2"
SN-3113C	●	0.68(17.2)	127	2000	22.0(622.6)	90(6.3)	17-3/4"(450)	17.6	8.0	1/2"	113.3	4.8	1/2"
SN-3123C	●	0.58(14.8)	127	2000	22.0(622.6)	90(6.3)	17-3/4"(450)	17.6	8.0	1/2"	113.3	4.8	1/2"
SN-3114C	●	0.68(17.2)	154	1600	24.0(679.2)	90(6.3)	18-1/2"(470)	18.3	8.3	1/2"	114.1	6.2	1/2"
SN-3124C	●	0.58(14.8)	154	1600	24.0(679.2)	90(6.3)	18-1/2"(470)	18.3	8.3	1/2"	114.1	6.2	1/2"
SN-3212C	●	0.68(17.2)	78	2300	20.0(566)	90(6.3)	14-5/8"(373)	17.2	7.8	1/2"	114.3	9.4	1/2"
SN-3222C	●	0.58(14.8)	78	2300	20.0(566)	90(6.3)	14-5/8"(373)	17.2	7.8	1/2"	114.3	9.4	1/2"
SN-3213C	●	0.68(17.2)	119	1900	22.0(622.6)	90(6.3)	16-1/2"(419)	18.7	8.5	1/2"	113.3	4.8	1/2"
SN-3223C	●	0.58(14.8)	119	1900	22.0(622.6)	90(6.3)	16-1/2"(419)	18.7	8.5	1/2"	113.3	4.8	1/2"
SN-3214C	●	0.68(17.2)	142	1700	24.0(679.2)	90(6.3)	17-1/2"(445)	19.4	8.8	1/2"	114.1	6.2	1/2"
SN-3224C	●	0.58(14.8)	142	1700	24.0(679.2)	90(6.3)	17-1/2"(445)	19.4	8.8	1/2"	114.1	6.2	1/2"

AIR NEEDLE SCALER



AIR NEEDLE SCALER

SN-1268 AIR NEEDLE SCALER



6 pieces in one carton



SN-1288 ^{TOP} AIR NEEDLE SCALER



10 pieces in one carton



SN-1368 AIR NEEDLE SCALER



6 pieces in one carton



SN-2124 AIR PISTOL GRIP NEEDLE SCALER



6 pieces in one carton



SN-2128 AIR PISTOL GRIP NEEDLE SCALER



6 pieces in one carton



SN-2110 AIR PISTOL GRIP NEEDLE SCALER



6 pieces in one carton



Item No.	Needle Diameter	Numbers of Needle	Stroke Length	Blow Per Minute	Avg. Air Consumption	Air Pressure	Overall Length	Net Weight		Air Hose	Sound Pressure	Vibration Level	Air Inlet
	mm	inch(mm)	mm	b.p.m	CFM (L/min)	PSI (bar)	inch(mm)	LBS	kg	Inch	dBA	m/s ²	Inch
SN-1268	3x180	19	28	4600	15(424)	90(6.3)	18-1/8"(460)	6.2	2.8	3/8"	91.0	13.7	1/4"
SN-1288	3x125	12	32	5500	3(85)	90(6.3)	11-3/8"(290)	2.9	1.3	3/8"	86.0	7.7	1/4"
SN-1368	3x180	19	27	3400	16(453)	90(6.3)	17"(430)	5.9	2.7	3/8"	91.0	13.7	1/4"
SN-2110	3x180	19	33	3700	15(424)	90(6.3)	13"(330)	6.1	2.8	3/8"	97.0	9.7	1/4"
SN-2124	3x180	23	27	4000	7.4(209)	90(6.3)	13-9/16"(350)	7.9	3.6	3/8"	99.0	14.8	3/8"
SN-2128	3x180	28	28	3500	7.4(198)	90(6.3)	13-9/16"(335)	6.2	2.8	3/8"	100.0	8.1	3/8"

AIR HYDRAULIC RIVETER

AIR HYDRAULIC RIVETER

ITEM	MATERIAL		RIVET DIAMETER(ØMM)							
			(2.5) 2.4	(3.0) 3.2	4.0	(5.0) 4.8	6.4	7.2	8.0	
RIVET	RIVET	MANDREL								
PA-111	aluminum	aluminum								
	aluminum	steel								
	steel	steel								
	stainless	stainless								
PA-201	aluminum	aluminum								
	aluminum	steel								
	steel	steel								
	stainless	stainless								
PA-201V	aluminum	aluminum								
	aluminum	steel								
	steel	steel								
	stainless	stainless								
PA-211	aluminum	aluminum								
	aluminum	steel								
	steel	steel								
	stainless	stainless								
PA-211VMC	aluminum	aluminum								
	aluminum	steel								
	steel	steel								
	stainless	stainless								
PA-301	aluminum	aluminum								
	aluminum	steel								
	steel	steel								
	stainless	stainless								
PA-301V	aluminum	aluminum								
	aluminum	steel								
	steel	steel								
	stainless	stainless								
PA-301D	aluminum	aluminum								
	aluminum	steel								
PA-301L	steel	steel								
	stainless	stainless								
PA-321	aluminum	aluminum								
	aluminum	steel								
	steel	steel								
	stainless	stainless								
PA-312V	aluminum	aluminum								
	aluminum	steel								
	steel	steel								
	stainless	stainless								
PA-301VMC	aluminum	aluminum								
	aluminum	steel								
	steel	steel								
	stainless	stainless								
PA-211TS	aluminum	aluminum								
	aluminum	steel								
	steel	steel								
	stainless	stainless								

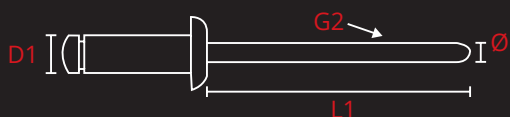

Hydramlic cylinder
Recommended Oil

- SHELL Tellus NO.46
- ESSO Teresso NO.46
- MOBIL D.TE 25 oil
- USM Spec NO.300B Oil
- CPC Circulation Oil R68

	Rivet (D1)	Mandrel (L1)	Rivet Dia. (Ø)
Blind Rivet	2.4mm	above27mm	1.42~1.51(G2)
	3.2mm	above28mm	1.83~1.92(G2)
	4.0mm	above29mm	2.28~2.42(G2)
	4.8mm	above30mm	2.64~2.91(G2)
	6.4mm	above30mm	3.84~4.15(G2)
PA-211TS	6.4mm	above40mm	3.84~4.15(G2)
	8.0mm	above40mm	4.35~4.65(G2)

PA-111



3 pieces in one carton



PA-201



6 pieces in one carton



PA-201V

Vaccum type



6 pieces in one carton



PA-211



6 pieces in one carton



PA-321



6 pieces in one carton



PA-312V

Vaccum type



6 pieces in one carton



PA-301V

Vaccum type



6 pieces in one carton



PA-301^{TOP}



10 pieces in one carton



PA-301D



2 pieces in one carton



PA-301L



Ext. tube



PA-203N



6 pieces in one carton



PA-MC

AUTOMATIC MANDREL COLLECTION

CONTENTS

- 3/32"(2.4mm) 220pcs
- 1/8" (3.2mm) 160pcs
- 5/32"(4.0mm) 110pcs
- 3/16"(4.8mm) 80pcs



PE-MC

AUTOMATIC MANDREL COLLECTION



Item No.	Traction Power	Stroke Length	Capacity	Avg. Air Consumption	Air Pressure	Net Weight		Air Hose	Sound Pressure	Vibration Level	Air Inlet
	lb.-f(kg.-f)	mm	mm	L/cycle	PSI (bar)	LBS	kg	Inch	dB(A)	m/s ²	Inch
PA-111	4100(1860)	26	4.8-6.4	2.88	90(6.3)	6.6	3.0	3/8"	82.0	0.8	1/4"
PA-201	3534(1603)	14	2.4-6.4	2.32	90(6.3)	3.9	1.8	3/8"	79.7	0.5	1/4"
PA-201V	3534(1603)	14	2.4-6.4	2.32	90(6.3)	3.9	1.8	3/8"	79.7	0.5	1/4"
PA-211	3748(1700)	18	2.4-6.4	2.9	90(6.3)	3.8	1.8	3/8"	79.7	0.8	1/4"
PA-321	2612(1185)	22	2.4-4.8	1.48	90(6.3)	3.3	1.5	3/8"	79.7	0.4	1/4"
PA-312V	1983(900)	18	2.4-4.8	1.8	90(6.3)	3.8	1.7	3/8"	75.3	0.4	1/4"
PA-301V	2303(1045)	16	2.4-4.8	1.48	90(6.3)	3.3	1.5	3/8"	79.7	0.3	1/4"
PA-301	2303(1045)	16	2.4-4.8	1.48	90(6.3)	3.3	1.5	3/8"	79.7	0.3	1/4"
PA-301D	2303(1045)	16	2.4-4.8	1.48	90(6.3)	3.3	1.5	3/8"	79.7	0.3	1/4"
PA-301L	2303(1045)	16	2.4-4.8	1.48	90(6.3)	3.3	1.5	3/8"	79.7	0.3	1/4"
PA-203	2640(1200)	16	3.2-6.4	1.48	90(6.3)	3.3	1.5	3/8"	79.7	0.5	1/4"

AIR HYDRAULIC RIVETER

AIR HYDRAULIC RIVETER



PB-2601 AIR HYDRAULIC NUT SETTER



5 pieces in one carton

- Fully automatic rivet gun functionality.



PA-211TS AIR HYDRAULIC RIVETER



6 pieces in one carton



PB-2402 AIR HYDRAULIC RIVET NUT TOOL



6 pieces in one carton



PB-1305 AIR RIVET NUT TOOL



12 pieces in one carton



PB-1308 AIR RIVET NUT TOOL



12 pieces in one carton



PB-1310 AIR RIVET NUT TOOL



12 pieces in one carton



PB-1312 AIR RIVET NUT TOOL



12 pieces in one carton



Item No.	Traction Power	No Load Speed	Stroke Length	Capacity	Avg. Air Consumption	Air Pressure	Net Weight		Air Hose	Sound Pressure	Vibration Level	Air Inlet
	lb.-f.(kg.-f)	R.P.M	mm	mm	L/cycle	PSI (bar)	LBS	kg	Inch	dBa	m/s ²	Inch
PB-2601	4300(594.5)	3500	0-7.0	M3-M12	7.5	90(6.3)	5.4	2.5	3/8"	80	1.2	1/4"
PA-211TS	3748(1700)	---	18	6.4&8.0	2.90	90(6.3)	3.8	1.8	3/8"	79.7	0.8	1/4"
PB-2402	3638(1650)	---	9	Steel M4.M10 Stainless M4.M8	1.50	90(6.3)	3.4	1.6	3/8"	82.0	0.8	1/4"
PB-1305	---	1200	---	M3.M4.M5	7.8	90(6.3)	2.4	1.1	3/8"	86.0	1.6	1/4"
PB-1308	---	600	---	M6.M8	7.8	90(6.3)	2.9	1.3	3/8"	86.0	1.6	1/4"
PB-1310	---	400	---	M8.M10	7.8	90(6.3)	2.8	1.3	3/8"	86.0	1.6	1/4"
PB-1312	---	400	---	M10.M12	7.8	90(6.3)	2.8	1.3	3/8"	86.0	1.6	1/4"

RIVETER ADAPTOR RIVET NUT ADAPTOR

PB-9006
M6 RIVET NUT ADAPTOR

PA-9048
4.8mm (3/16") RIVET ADAPTOR

PB-9010
M10 RIVET NUT ADAPTOR

PA-9064
6.35mm (1/4") RIVET ADAPTOR



PA-9048PT
RIVETER ADAPTOR

PA-48PB06T
RIVETER ADAPTOR + RIVET NUT ADAPTOR

PB-9006PT
RIVET NUT ADAPTOR



PB-9006P
M6 RIVET NUT ADAPTOR

PA-9048P
4.8mm (3/16") RIVET ADAPTOR

PB-9010P
M10 RIVET NUT ADAPTOR

PA-9064P
6.35mm (1/4") RIVET ADAPTOR



Assembling And Using Before First Use

Remove the unit and the accessory out of the packaging. Keep packaging materials out of reach of children. There is risk of suffocation.



TECHNICAL DATA

PA-9064

Dimensions	59mm x 173mm(2-11/16" x 6-3/4")
Net Weight	330g=0.73 lbs
Gross Weight	500g=1.10 lbs
Nosepiece	3.2mm(1/8"), 4.0mm(5/32")
Nosepiece	4.8mm(3/16"), 6.4mm(1/4")
Hex Shank	1/4"(6.35mm)
Cordless Drill	14.4V, 18V
Cordless Drive	14.4V, 18V
Reversible electric	1/2"Drill
Reversible pneumatic	1/2"Drill
Min. Torque Strength	50 Nm = 37 ft/lbs
Max. rpm	1000 rpm

1. Hex Shank	1/4" (6.35mm)
2. Housing	PA+GF
3. Nosepiece	3.2mm, 4.0mm, 4.8mm, 6.4mm
4. Sight Window	Blind Rivet Loading
5. Wrench	1PC
6. Handle	1PC

PB-9006

Dimensions	59mm x 172mm(2-11/32" x 6-25/32")
Net Weight	280g=0.62 lbs
Nosepiece	M3.M4.M5.M6
Hex Shank	1/4"(6.35mm)
Cordless Drill	12V, 14.4V
Cordless Drive	12V, 14.4V
Reversible electric	Drill(Advice 500W)
Reversible pneumatic	Drill(Advice 3/8")
Min. Torque Strength	15 Nm = 11 ft/lbs
Max. rpm	1000 rpm

PA-9048

Dimensions	59mm x 158mm(2-11/32" x 6-1/4")
Net Weight	318g=0.70 lbs
Gross Weight	368g=0.81 lbs
Nosepiece	2.4mm(3/32"), 3.2mm(1/8")
Nosepiece	4.0mm(5/32"), 4.8mm(3/16")
Hex Shank	1/4"(6.35mm)
Cordless Drill	12V, 14.4V, 18V
Cordless Drive	12V, 14.4V, 18V
Reversible electric	3/8"Drill
Reversible pneumatic	3/8"Drill
Min. Torque Strength	11 Nm = 8 ft/lbs
Max. rpm	1000 rpm

1. Hex Shank	1/4" (6.35mm)
2. Housing	PA+GF
3. Nosepiece	2.4mm, 3.2mm, 4.0mm, 4.8mm
4. Sight Window	Blind Rivet Loading
5. Wrench	1PC

PB-9010

Dimensions	59mm x 180mm(2-11/32" x 7-3/32")
Net Weight	350g=0.77 lbs
Nosepiece	M6.M8.M10
Hex Shank	1/4"(6.35mm)
Cordless Drill	14.4V
Cordless Drive	18V
Reversible electric	Drill(Advice 500W)
Reversible pneumatic	Drill(Advice 1/2")
Min. Torque Strength	100 Nm = 73.7 ft/lbs
Max. rpm	800 rpm

RIVETER ADAPTOR / RIVET NUT ADAPTOR

AIR NAILER & AIR STAPLER

AIR NAILER & AIR STAPLER

SJ-FN90E AIR FRAMING NAILER 34°



2 pieces in one carton

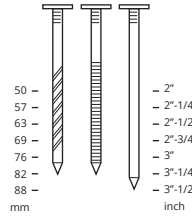

Item No.	Collated	Nail Head	Nail Length		Shank Dia		Load Capacity	Working Pressure	Weight	Air Inlet
			mm(inch)	mm	mm	Nails				
SJ-FN90E	Paper/Wire	Clipped Head	50-90(2"~3-1/2")	2.9	3.3	75-105	90	3.9	1/4"	

SJ-1650T AIR NAILER SAFETY TRIGGER



5 pieces in one carton

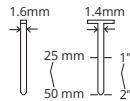

SJ-1830F AIR NAILER SAFETY TRIGGER



10 pieces in one carton

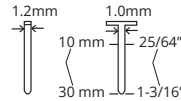

SJ-C1830F AIR NAILER SAFETY TRIGGER



10 pieces in one carton

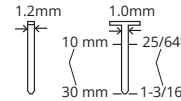

SJ-1850F AIR NAILER SAFETY TRIGGER



10 pieces in one carton

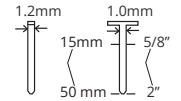

SJ-TN64 AIR CONCRETE NAILER



4 pieces in one carton

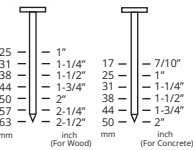

SJ-BNF1664 AIR BRAD NAILER



10 pieces in one carton

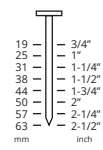

SU-C422J AIR NAILER



10 pieces in one carton

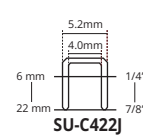

SU-C1022J AIR NAILER



10 pieces in one carton

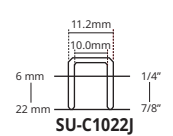

Item No.	Head Dia.	Gauge	Nail Length		Crown		Shank (Thickness/Width)		Load Capacity	Working Pressure	Weight	Air Inlet
	mm		mm(inch)	mm	mm	mm	mm	Nails				
SJ-1650T	2.8	16	20-50(3/4"~2")	---	---	1.4	1.60	100	90	2.4	1/4"	
SJ-1830F	1.9	18	10-30(3/8"~1-2/11")	---	---	1.0	1.2	100	90	1.2	1/4"	
SJ-1850F	---	18	16-50(8/5"~2")	---	---	1.0	1.2	100	90	1.4	1/4"	
SJ-TN64	7.5	13	(18-64)	---	---	2.5	2.50	80	90	2.4	1/4"	
SJ-BNF1664	2.8	16	(20-64)	---	---	1.4	1.60	100	90	2.4	1/4"	
SU-C422J	---	20	6-22(1/4"~7/8")	4	0.6x1.2	---	---	100	90	1.2	1/4"	
SU-C1022J	1.9	20	6-22(1/4"~7/8")	10	0.6x1.2	---	---	100	90	1.2	1/4"	

SU-8016 AIR STAPLER SAFETY TRIGGER



10 pieces in one carton

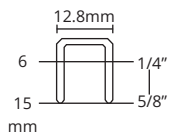

SU-9025 AIR STAPLER SAFETY TRIGGER



10 pieces in one carton

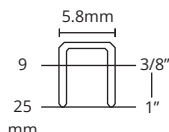

SU-9040 AIR STAPLER SAFETY TRIGGER



4 pieces in one carton

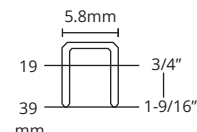

Item No.	Gauge	Nail Length		Crown		Load Capacity	Working Pressure	Weight	Air Inlet
		mm(inch)	mm	mm	mm				
SU-8016	21	6-16(1/4"-5/8")	12.8	0.65x0.95	100	90	0.9	1/4"	
SU-9025	18	10-25(3/8"-1")	5.8	1.0x1.25	100	90	1.1	1/4"	
SU-9040	18	10-40(3/4"-1-9/16")	5.8	1.2x1.25	100	90	2.2	1/4"	

SU-H3218S HAND CARTON STAPLER



5 pieces in one carton



SU-H3222S HAND CARTON STAPLER



5 pieces in one carton



SU-H3518S HAND CARTON STAPLER



5 pieces in one carton



SU-H3522S HAND CARTON STAPLER



5 pieces in one carton



SU-A3218S AIR CARTON STAPLER



5 pieces in one carton

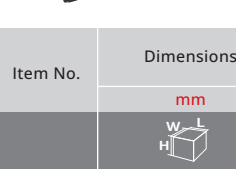

SU-A3222S AIR CARTON STAPLER



5 pieces in one carton



SU-A3518S AIR CARTON STAPLER



5 pieces in one carton

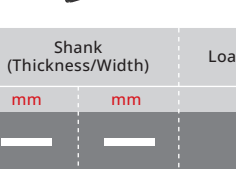

SU-A3522S AIR CARTON STAPLER



5 pieces in one carton

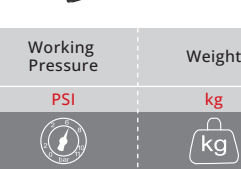

Item No.	Dimensions	Nail Length	Crown	Shank (Thickness/Width)		Load Capacity	Working Pressure	Weight
	mm			mm	mm			
SU-A3518S	200x102x400	15 & 18	34.8	0.9	2.2	100	90	2.5
SU-A3522S	200x102x400	22	34.8	0.9	2.2	100	90	2.5
SU-A3218S	200x102x400	15 & 18	32.1	0.9	1.9	100	90	2.5
SU-A3222S	200x102x400	22	32.1	0.9	1.9	80	90	2.5
SU-H3518S	310x102x460	15 & 18	34.8	0.9	2.2	100	---	2.2
SU-H3522S	310x102x460	22	34.8	0.9	2.2	100	---	2.2
SU-H3218S	310x102x460	15 & 18	32.1	0.9	1.9	100	---	2.2
SU-H3222S	310x102x460	22	32.1	0.9	1.9	100	---	2.2

AIR NAILER & AIR STAPLER

AIR NAILER & AIR STAPLER



SJ-CN55

COIL NAILER SAFETY TRIGGER



4 pieces in one carton

- Ideal for pallet assembly and manufacturing.

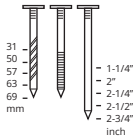

SJ-CN57

57mm AIR COIL NAILER SAFETY TRIGGER



4 pieces in one carton

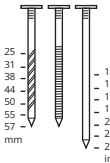

SJ-CN65

65mm AIR COIL NAILER SAFETY TRIGGER



4 pieces in one carton

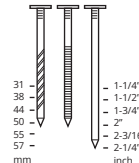

SJ-CN70

COIL NAILER SAFETY TRIGGER



4 pieces in one carton

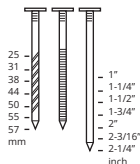

SJ-CN90

AIR COIL NAILER



4 pieces in one carton

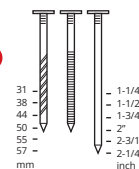

Item No.	Shank Dia.	Head Dia.	Nail Length	Collated	Driving Power	Load Capacity	Dimensions	Working Pressure	Weight	Air Inlet
	mm	mm	mm		(ft-lb)		(HxWxL)mm	PSI	kg	Inch
SJ-CN55	2.1-2.3	5.0-5.7	25-57	Wire	36.54	300-350	283x131x270	90	2.8	1/4"
SJ-CN57	2.1-2.3	5.0-6.0	25-57	Wire/Plastic Sheet	36.40	200-300	310x130x300	90	2.2	1/4"
SJ-CN65	2.3-2.5	5.0-6.0	32-65	Wire/Plastic Sheet	39.70	200-300	330x130x300	90	2.3	1/4"
SJ-CN70	2.3-2.9	5.7-7.0	45-70	Wire	61.07	150-300	303x129x307	90	3.7	1/4"
SJ-CN90	2.5-3.3	6.0-7.2	50-90	Wire	79.43	150-300	375x125x340	90	3.7	1/4"

AIR GREASE GUN

SG-400C COMPOSITE AIR GREASE GUN



SG-400 AIR GREASE GUN



SG-500 AIR GREASE GUN



SG-401 AIR GREASE GUN Continuous type



- Trigger lock allows continuous grease application.

SG-501 AIR GREASE GUN Continuous type



- Trigger lock allows continuous grease application.



SG-405 AIR GREASE GUN



- SG-400 + SG-902 400ml
- Key Spec :
- Single shot type
- 19.6mm & 33.6mm
- Thread Adapter Included



SG-407 AIR GREASE GUN Continuous type



- SG-401 + SG-902 400ml
- Key Spec :
- Single shot type
- 19.6mm & 33.6mm
- Thread Adapter Included



SG-902 GREASE TUBE ADAPTER

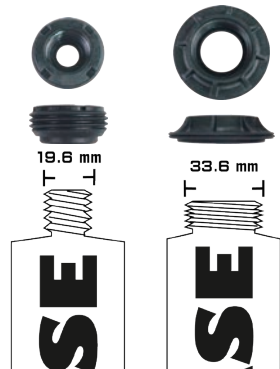

SG-910 90° GREASE COUPLER

- 1/8 x 27 Thread



SG-910S 90° GREASE COUPLER

- 1/8 x 27 Thread



SG-911 360° SWIVEL GREASE COUPLER

- 1/8 x 27 Thread



SG-912 QUICK RELEASE GREASE COUPLER

- 1/8 x 27 Thread



SG-912L QUICK RELEASE GREASE COUPLER

- 1/8 x 27 Thread



Item No.	Working Pressure	Proof Pressure	Capacity	Net Weight		Air Hose	Sound Pressure	Vibration Level	Air Inlet
	kgf/cm ²	kgf/cm ²	C.C	LBS	kg	Inch	dBA	m/s ²	Inch
SG-400	2.8-8.4	10.5	400	3.2	1.5	3/8"	80.2	0.7	1/4"
SG-500	2.8-8.4	10.5	500	3.5	1.6	3/8"	80.2	0.7	1/4"
SG-400C	2.8-8.4	10.5	400	2.2	1.0	3/8"	81.4	0.6	1/4"
SG-401	2.8-8.4	10.5	400	3.5	1.6	3/8"	74.0	2.0	1/4"
SG-501	2.8-8.4	10.5	500	3.7	1.7	3/8"	74.0	2.0	1/4"

AIR GREASE GUN

AIR BLOW GUN

AIR BLOW GUN

JC-202
AIR BLOW GUN
60 pieces in one carton



JC-405
AIR BLOW GUN
100 pieces in one carton



JC-410
AIR BLOW GUN
50 pieces in one carton



JC-412
AIR BLOW GUN
50 pieces in one carton



JC-424
AIR BLOW GUN
50 pieces in one carton



JC-435
AIR BLOW GUN
50 pieces in one carton



JC-491
STANDARD SAFETY TIP
Available with JC-491 for JC-405, JC-410, JC-412, JC-424, JC-435



JC-602
HIGH VOLUME AIR BLOW GUN
20 pieces in one carton



JC-640
SUPER AIR BLOW GUN
30 pieces in one carton



JC-641
SUPER AIR BLOW GUN
30 pieces in one carton



JC-680
SUPER AIR BLOW GUN
30 pieces in one carton



JC-0415[SET]
AIR BLOW GUN
4 set in one carton

Contents
JC-405 15PCS



JC-0424[SET]
AIR BLOW GUN
4 set in one carton

Contents
JC-405 8PCS
JC-410 8PCS
JC-412 8PCS



Item No.	Nozzle Length	Working Pressure	Max Pressure	Avg. Air Consumption	Avg. Air Consumption	Net Weight		Air Hose	Sound Pressure	Air Inlet
	inch	PSI(bar)	PSI(bar)	CFM(L/min)	CFM(L/min)	LBS	kg	Inch	dB(A)	Inch
JC-202	7"-12"	90-120(6.2-8.5)	220(15.1)	---	5.10(144)	0.4	0.2	3/8"	90.0	1/4"
JC-405	5"	75-120(5.3-8.5)	150(10.6)	13.0(368)	15.0(425)	0.2	0.1	3/8"	90.0	1/4"
JC-410	10"	75-120(5.3-8.5)	150(10.6)	13.0(368)	15.0(425)	0.3	0.1	3/8"	90.0	1/4"
JC-412	12"	75-120(5.3-8.5)	150(10.6)	13.0(368)	15.0(425)	0.3	0.1	3/8"	90.0	1/4"
JC-424	24"	75-120(5.3-8.5)	150(10.6)	13.0(368)	15.0(425)	0.3	0.1	3/8"	90.0	1/4"
JC-435	35"	75-120(5.3-8.5)	150(10.6)	13.0(368)	15.0(425)	0.6	0.3	3/8"	90.0	1/4"
JC-602	2"	90-120	230	13.0(368)	15.0(425)	0.4	0.2	3/8"	90.0	1/4"
JC-640	40"	75-120(5.3-8.5)	150(10.6)	13.0(368)	15.0(425)	1.4	0.7	3/8"	90.0	1/4"
JC-641	40"	75-120(5.3-8.5)	150(10.6)	13.0(368)	15.0(425)	0.8	0.3	3/8"	90.0	1/4"
JC-680	80"	75-120(5.3-8.5)	150(10.6)	13.0(368)	15.0(425)	1.4	0.6	3/8"	90.0	1/4"

AUTO REPAIR TOOL

INC-0208[SET]

1/4" DRIVE Twin dog type



10 pieces in one carton

Contents 8 pcs

- 1pc - 1/4" Air Impact Wrench (NC-2710)
- 5pcs - Impact sockets : 8, 9, 10, 11, 12 mm
- 1pc - 1/4" Drive Universal Joint
- 1pc - 1/4" Extension Bar
- 1pc - 1/4" plug



NC-2710



INC-2210N[SET]

1/4" DRIVE Twin dog type



1 carton / 5 set 20 pieces in one carton

Contents 10 pcs

- 1pc - 1/4" Air Impact Wrench (NC-2210)
- 5pcs - Impact sockets : 8, 9, 10, 11, 12 mm
- 1pc - 1/4" Drive Universal Joint
- 2pcs - 1/4" Extension Bar (L : 50, 125mm)
- 1pc - 1/4" plug



NC-2210



Item No.	Square Drive	Bolt Capacity	Torque Range	Max Torque		No Load Speed	Avg. Air Consumption	Air Pressure	Overall Length	Net Weight		Air Hose	Sound Pressure	Vibration Level	Air Inlet
	Inch	Inch (mm)	ft-lb (Nm)	ft-lb	Nm	R.P.M	CFM (L/min)	PSI (bar)	Inch (mm)	LBS	kg	Inch	dBA	m/s ²	Inch
NC-2710	1/4"	M8	7.4-29.5(10-40)	29	40	11000	5.3(150)	90(6.3)	5-3/8"(136)	1.8	0.8	3/8"	91.0	3.4	1/4"
NC-2210	1/4"	M5	4-45(6-61)	50	67.8	11000	1.8(51)	90(6.3)	6-17/32"(166)	1.7	0.8	3/8"	77.0	1.8	1/4"

QA-651N[SET]

AIR DIE GRINDER



1 carton / 5 set 20 pieces in one carton

Contents 16 pcs

- 1pc - Air Die Grinder (QA-651)
- 1pc - Collet : 3mm (or 1/8")
- 5pcs - Grinder Stones 3mm
- 5pcs - Grinder Stones 6mm
- 2pcs - Spanner Wrench
- 1pc - 1/4" plug
- 1pc - Oil Box



QA-651



Item No.	Collet Size	No Load Speed	Avg. Air Consumption	Air Pressure	Overall Length	Motor	Net Weight		Air Hose	Sound Pressure	Vibration Level	Air Inlet
	inch(mm)	R.P.M	CFM (L/min)	PSI (bar)	Inch (mm)	HP	LBS	kg	Inch	dBA	m/s ²	Inch
QA-651	1/4"(6)	18000	2.7(76)	90(6.3)	5"(127)	0.3	1.1	0.5	3/8"	74.0	0.3	1/4"

QB-0618[SET]

90° MINI SANDER 18 PCS SET



10 pieces in one carton

Contents 18 pcs

- 1pc - QB-625
- 1pc - Disc 2" PAD
- 1pc - Disc 3" PAD
- Removal Sandering
- 1pc - 2" #80-YL
- 2pcs - 2" #150-RD
- 2pcs - 2" #300-BL
- 1pc - 2" Stripping Disc
- 1pc - 3" #80-YL
- 2pcs - 3" #150-RD
- 2pcs - 3" #300-BL
- 1pc - 3" Stripping Disc
- 1pc - Adaptor
- 1pc - Spanner
- 1pc - Oil



QB-625



Item No.	Pad Dia / Arbor Size	No Load Speed	Avg. Air Consumption	Air Pressure	Overall Length	Motor	Net Weight		Air Hose	Sound Pressure	Vibration Level	Air Inlet
	inch	R.P.M	CFM	PSI (bar)	Inch (mm)	HP	LBS	kg	Inch	dBA	m/s ²	Inch
QB-625	2" / 3"	15000	17.2	90(6.3)	7-1/8"(180)	0.6	1.3	0.6	3/8"	75	2.5	1/4"

AUTO REPAIR TOOL

AUTO REPAIR TOOL

AUTO REPAIR TOOL

QE-323N[SET]

1/4" AIR REVERSIBLE DRILL



1 carton / 5 set 20 pieces in one carton

Contents 9 pcs

- 1pc - 3.5mm Drill Bits
- 1pc - 4.0mm Drill Bits
- 1pc - 4.5mm Drill Bits
- 1pc - 5.0mm Drill Bits
- 1pc - 5.5mm Drill Bits
- 1pc - Key Wrench
- 1pc - 1/4" Plug
- 1pc - Oil Box
- 1pc - Air Reversible Drill(QE-323)



QE-323



Item No.	Chuck Size	No Load Speed	Motor	Overall Length	Avg. Air Consumption	Air Pressure	Net Weight		Air Hose	Sound Pressure	Vibration Level	Air Inlet
	inch(mm)	R.P.M	HP	inch(mm)	CFM (L/min)	PSI (bar)	LBS	kg	Inch	dB(A)	m/s ²	Inch
QE-323	1/4"(6.35)	1600	0.38	6-15/32"(164)	1.9(54)	90(6.3)	1.7	0.8	3/8"	74.0	1.2	1/4"

QP-212N[SET]

AIR HIGH SPEED SANDER



1 carton / 5 set 20 pieces in one carton

Contents 12 pcs

- 1pc - Air High Speed Sander
- 1pc - 2" Rubber PAD(1/4"-20)
- 1pc - 2" Pad Die#80
- 1pc - 2" Stripping Disc #80-YL(Coarse)
- 1pc - 2" Stripping Disc #150-RD(Med)
- 1pc - 3" Pad Die#80
- 1pc - 3" Stripping Disc #80-YL(Coarse)
- 1pc - 3" Stripping Disc #150-RD(Med)
- 1pc - 1/4" Plug
- 1pc - Oil Box
- 1pc - Spanner Wrench



QP-212



QP-213N[SET]

AIR ORBIT SANDER



1 carton / 5 set 20 pieces in one carton

Contents 67 pcs

- 1pc - Air Sander
- 1pc - 2" PAD(5/16"-24)
- 1pc - 3" PAD (5/16"-24)
- 10pcs - 2" Sandpaper#180
- 10pcs - 2" Sandpaper#220
- 10pcs - 2" Sandpaper#320
- 1pc - 1/4" Plug
- 1pc - Oil Box
- 2pcs - Spanner Wrench
- 10pcs - 3" Sandpaper#180
- 10pcs - 3" Sandpaper#220
- 10pcs - 3" Sandpaper#320



QP-213



QP-223N[SET]

AIR MINI POLISHER



1 carton / 5 set 20 pieces in one carton

Contents 7 pcs

- 1pc - Air Mini Polisher(QP-223)
- 1pc - 3"PAD(5/16"-24)
- 1pc - 3"Sponge (Medium)
- 1pc - 3"Sponge (Rough)
- 1pc - 3"Wool Bonnet
- 1pc - 1/4"Plug
- 1pc - Spanner Wrench



QP-223



QP-415

AIR ANGLE POLISHER



10 pieces in one carton



Stylized grip

Item No.	Pad Dia	Spindle Size	No Load Speed	Avg. Air Consumption	Air Pressure	Overall Length	Motor	Net Weight		Air Hose	Sound Pressure	Vibration Level	Air Inlet
	inch(mm)		R.P.M	CFM (L/min)	PSI (bar)	Inch (mm)	HP	LBS	kg	Inch	dB(A)	m/s ²	Inch
QP-212	2" or 3"	1/4"-20	18000	2.1(59)	90(6.3)	4-1/4"(107)	0.3	1.1	0.5	3/8"	73.0	0.9	1/4"
QP-213	2" or 3"	5/16"-24	18000	2.1(59)	90(6.3)	4-5/8"(117)	0.3	1.1	0.5	3/8"	76.0	1.2	1/4"
QP-223	3"(76)	5/16"-24	5500	2.2(62)	90(6.3)	5-1/8"(130)	0.38	1.3	0.6	3/8"	74.0	0.9	1/4"
QP-415	5"(127)	5/16"-24	2500	5.0(141)	90(6.3)	8-11/32"(211)	0.5	2.5	1.1	3/8"	85.0	1.1	1/4"

RA-505N[SET]

AIR SCREWDRIVER

Twin dog type Screw capacity : M5



1 carton / 5 set 20 pieces in one carton

Contents 8 pcs

- 1pc Air Screwdriver
- 2pcs Bits FD(L:50mm)
- 2pcs Bits PH2(L:65mm)
- 1pcs Bits PH2(L:100mm)
- 1pc 1/4"Plug
- 1pc Oil Box



RA-505



Item No.	Bit Size	Torque Range	No Load Speed	Overall Length	Avg. Air Consumption	Air Pressure	Net Weight		Air Hose	Sound Pressure	Vibration Level	Air Inlet
	inch(mm)	ft-lb (Nm)	R.P.M	inch(mm)	CFM (L/min)	PSI (bar)	LBS	kg	Inch	dBA	m/s ²	Inch
RA-505	1/4"(6.35)	5-45(6-61)	11000	6-5/16"(161)	1.8(51)	90(6.3)	1.5	0.7	3/8"	74.0	3.3	1/4"

QT-102

AIR TYRE BUFFER



20 pieces in one carton



QT-103

AIR TYRE BUFFER



20 pieces in one carton



QT-203

AIR TYRE BUFFER



20 pieces in one carton



QT-113

QUICK CHANGE CHUCK



20 pieces in one carton



QT-112T

AIR TYRE BUFFER



10 pieces in one carton



Stylized grip



2pcs Planet Gear with bearing

QT-203T

AIR TYRE BUFFER



20 pieces in one carton



Stylized grip



2pcs Planet Gear with bearing

QT-303

QUICK CHANGE CHUCK



20 pieces in one carton



Stylized grip



2pcs Planet Gear with bearing

Item No.	Chuck Size	Collet Size	No Load Speed	Avg. Air Consumption	Air Pressure	Overall Length	Motor	Net Weight		Air Hose	Sound Pressure	Vibration Level	Air Inlet
	inch(mm)	inch(mm)	R.P.M	CFM (L/min)	PSI (bar)	Inch (mm)	HP	LBS	kg	Inch	dBA	m/s ²	Inch
QT-102	---	1/4"(6)	7000	3.0(85)	90(6.3)	5-1/2"(140)	0.3	0.9	0.4	3/8"	77.0	1.3	1/4"
QT-103	---	1/4"(6)	7000	3.0(85)	90(6.3)	5-1/2"(140)	0.3	0.9	0.4	3/8"	77.0	1.3	1/4"
QT-203	Hex.7/16"(11.1)	---	4000	10.6(300)	90(6.3)	9-3/4"(250)	0.5	1.8	0.8	3/8"	75.0	0.87	1/4"
QT-113	Hex.7/16"(11.1)	---	2500	10.6(300)	90(6.3)	9-3/4"(250)	0.5	1.8	0.8	3/8"	75.0	0.87	1/4"
QT-112T	---	1/4"(6)	4000	5.0(141)	90(6.3)	8-27/32"(225)	0.5	1.7	0.8	3/8"	85.0	1.2	1/4"
QT-203T	Hex.7/16"(11.1)	---	4000	5.0(141)	90(6.3)	8-27/32"(225)	0.5	2.0	0.9	3/8"	85.0	1.6	1/4"
QT-303	Hex.7/16"(11.1)	---	22000	5.0(141)	90(6.3)	8-9/16"(217)	0.5	1.7	0.8	3/8"	85.0	1.6	1/4"

SK-1010

AIR CAULKING GUN

10 pieces in one carton



SK-1131

AIR CAULKING GUN

6 pieces in one carton

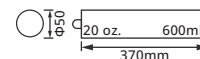

Item No.	Capacity	Overall Length	Avg. Air Consumption	Air Pressure	Net Weight		Air Hose	Air Inlet
	ml(oz)	inch(mm)	CFM (L/min)	PSI (bar)	LBS	kg	Inch	Inch
SK-1010	300(13.5)	12"(305)	4.0(113)	50-70(3.4-4.8)	2.4	1.1	3/8"	1/4"
SK-1131	300(13.5) / 600(20)	24-7/16"(620)	4.0(113)	60-90(4.1-6.2)	2.7	1.2	3/8"	1/4"

AUTO REPAIR TOOL

AUTO REPAIR TOOL

QB-0808

AIR SURFACE-CLEANING TOOL

- ★ ★ ★
- 10 pieces in one carton

Contents

- 1pc - Air Surface-Cleaning Tool (QB-802)
- 1pc - Eraser Wheel
- 1pc - Stripping Wheel
- 1pc - Wire Wheel (Coarse)
- 1pc - Wire Wheel
- 1pc - Allen Key 6mm
- 1pc - Spanner Wrench
- 1pc - 1/4" Plug
- Adapter Male UNF 5/16"-24
- 1pc - Female M6x1.0



QB-9415 QB-9414 QB-9411 QB-9412 QB-9400

QB-0808U For USA

AIR SURFACE-CLEANING TOOL

- ★ ★ ★
- 10 pieces in one carton

Contents

- 1pc - Air Surface-Cleaning Tool (QB-802)
- 1pc - Eraser Wheel
- 1pc - Stripping Wheel
- 1pc - Wire Wheel (Coarse)
- 1pc - Wire Wheel
- 1pc - Allen Key 6mm
- 1pc - Spanner Wrench
- 1pc - 1/4" Plug
- Adapter Male UNF 5/16"-24
- 1pc - Female M6x1.0



QB-9415 QB-9414U QB-9411 QB-9412 QB-9400



QB-802

AIR SURFACE-CLEANING TOOL

- ★ ★ ★
- 10 pieces in one carton



QB-802U For USA

AIR SURFACE-CLEANING TOOL

- ★ ★ ★
- 10 pieces in one carton



QB-802T

AIR ERASER

- ★ ★ ★
- 10 pieces in one carton



QB-802TU For USA

AIR ERASER

- ★ ★ ★
- 10 pieces in one carton



QB-812

AIR ERASER

- ★ ★ ★
- 10 pieces in one carton



QB-812U For USA

AIR ERASER

- ★ ★ ★
- 10 pieces in one carton



QB-812T

AIR ERASER

- ★ ★ ★
- 10 pieces in one carton



QB-812TU For USA

AIR ERASER

- ★ ★ ★
- 10 pieces in one carton



Item No.	Spindle Size	No Load Speed	Avg. Air Consumption	Air Pressure	Overall Length	Motor	Net Weight		Air Hose	Sound Pressure	Vibration Level	Air Inlet
		R.P.M	CFM (L/min)	PSI (bar)	Inch (mm)	HP	LBS	kg	Inch	dBA	m/s ²	Inch
QB-802	3/8"-24	3600	10.6(300)	90(6.3)	7-7/8"(200)	0.7	2.6	1.2	3/8"	86	0.3	1/4"
QB-802T	3/8"-24	4000	5.0(141)	90(6.3)	8-5/32"(212)	0.5	3.1	1.4	3/8"	85.0	1.2	1/4"
QB-812	3/8"-24	4000	10.0(283)	90(6.3)	8-7/8"(225)	0.5	1.7	0.8	3/8"	75	0.87	1/4"
QB-812T	3/8"-24	4000	5.0(141)	90(6.3)	8-15/32"(215)	0.5	1.7	0.8	3/8"	85.0	1.2	1/4"

SB-201
DIGITAL TYRE INFLATOR
20 pieces in one carton



SB-215
DIGITAL TYRE INFLATOR
12 pieces in one carton



SB-3030
DIGITAL TYRE INFLATOR
12 pieces in one carton



SB-3038
DIGITAL TYRE INFLATOR
20 pieces in one carton



SB-3130
DIGITAL TYRE INFLATOR
20 pieces in one carton



SB-422
TYRE INFLATOR
20 pieces in one carton



SB-423
TYRE INFLATOR
12 pieces in one carton



SB-710
TYRE INFLATOR
12 pieces in one carton



SB-2031
TYRE INFLATOR
20 pieces in one carton

- Dial face size : Ø3.5"
- Short piping



SB-2131
TYRE INFLATOR
20 pieces in one carton

- Dial face size : Ø3.5"
- Long piping 100cm



SB-4031
TYRE INFLATOR
20 pieces in one carton

- Dial face size : Ø3.5"
- Short piping



SB-4151
TYRE INFLATOR
20 pieces in one carton

- Dial face size : Ø3.5"
- Long piping 150cm



SB-501
TYRE INFLATOR
12 pieces in one carton



Item No.	Max Pressure	Nozzle Length	Air Consumption at 100PSI	Air Pressure	Net Weight		Air Hose	Air Inlet	Nozzle
	PSI (bar)	cm	CFM	PSI (bar)	LBS	kg	Inch	Inch	
SB-201	160(11.0)	30	1.41	90(6.3)	0.7	0.3	3/8"	1/4"	Tyre valve clip
SB-215	160(11.0)	150	1.41	90(6.3)	0.9	0.4	3/8"	1/4"	Tyre valve clip
SB-3030	200(14.0)	30	1.41	90(6.3)	1.1	0.5	3/8"	1/4"	Tyre valve clip
SB-3038	200(14.0)	85	1.41	90(6.3)	1.5	0.7	3/8"	1/4"	Tyre valve clip
SB-3130	200(14.0)	100	1.41	90(6.3)	1.3	0.6	3/8"	1/4"	Tyre valve clip
SB-422	160(11.0)	45	1.41	90(6.3)	1.2	0.6	3/8"	1/4"	Tyre valve clip
SB-423	220(15.0)	100	1.41	90(6.3)	2.9	1.3	3/8"	1/4"	Tyre valve clip
SB-710	200(13.8)	100	1.41	90(6.3)	1.0	0.5	3/8"	1/4"	Tyre valve clip
SB-2031	160(11.0)	30	1.41	90(6.3)	1.3	0.6	3/8"	1/4"	One touch clip
SB-2131	160(11.0)	100	1.41	90(6.3)	1.4	0.7	3/8"	1/4"	One touch clip
SB-4031	160(11.0)	30	1.41	90(6.3)	1.3	0.6	3/8"	1/4"	One touch clip
SB-4151	160(11.0)	150	1.41	90(6.3)	1.4	0.7	3/8"	1/4"	One touch clip
SB-501	160(11.0)	30	1.41	90(6.3)	2.9	1.3	3/8"	1/4"	Dual chuck

AUTO REPAIR TOOL

QM-1125 PNEUMATIC CV JOINT BOOTS FITTING TOOL



4 pieces in one carton



FEATURES

- This air powered tool is designed and constructed to be used for installing CV boots of cars, small vans, and light duty commercial vehicles. Any other not intended use is forbidden.

Item No.	Capacity	Overall Length	Max Air Pressure	Air Pressure	Net Weight		Air Hose	Air Inlet
	inch(mm)	inch(mm)	PSI (bar)	PSI (bar)	LBS	kg	Inch	Inch
QM-1125	1"~4-3/8"(25-110)	17-3/8"(442)	125(8.6)	90(6.3)	7.2	3.3	3/8"	1/4"

SM-111R AIR DENT PULLER



4 pieces in one carton



FEATURES

- Large area and slight depression of the sheet metal can be quickly repaired.
- Three sizes of suction cups can be used in different areas of depression.
- Simple structure and long product life.

Item No.	Pad Dia	Exhaust Direction	Maximum Pulling Force	Air Pressure	Overall Length	Avg. Air Consumption	Net Weight		Slide Hammer Weight		Air Inlet
	inch(mm)		kg	PSI (bar)	Inch (mm)	CFM (L/min)	LBS	kg	LBS	kg	Inch
SM-111R	3", 4.5", 6"(78, 115, 155)	Rear	90-100	90(6.3)	44-1/8"(1120)	8.5(240)	6.0	2.8	3.5	1.6	1/4"

SC-0320 AIR VIBRATION INJECTOR PULLER

3 pieces in one carton



FEATURES

- Design to replace the sliding hammer without hand using.
- Save the power and time to pull out the injector from engine.
- High torque and two speeds design for pull out the injector quickly.

Item No.	Piston Stroke	Stroke Speed	Max Torque	Spindle Thread	Working Pressure	Max. air Pressure	Overall Length	Air Hose	Weight	Air Inlet
	mm	bpm	Nm		PSI (bar)	PSI (bar)	mm	mm	kg	Inch
SC-0320	38	300/900	600	M18 x 1.5	87-130.5(6-9)	140.5(10)	500	12	2.7	1/4"

SM-0503 PNEUMATIC BRAKE EXTRACTOR & REFILLED KIT

1 pieces in one carton



SM-0813 MANUAL & FLUID EXTRACTOR

4 pieces in one carton



Item No.	Air Pressure	Net Weight		Capacity	Air Inlet
	PSI	LBS	kg	L	Inch
SM-0503	70-170	4.1	1.9	3.0	1/4"
SM-0813	70-170	6.8	2.7	8.0	1/4"

WG-202N[SET]

AIR SUCTION & BLOW GUN KIT

Air inlet 1/4"

10 pieces in one carton

Contents 8 pcs

- 1pc - Extension Tube
- 1pc - Small Diameter Vacuum Tube
- 1pc - Flat Tube
- 1pc - Brush
- 1pc - Flexible tube
- 1pc - Deflector
- 1pc - Clamping Ring
- 1pc - Dust Bag



WG-202

20 pieces in one carton

SR-2001 KIT

AIR BRUSH KIT

40 pieces in one carton

Contents 9 pcs

- 1pc - Airbrush
- 1pc - 22c.c. Glass Jar
- 1pc - 50c.c. Glass Jar
- 1pc - 55FT(M5 x 0.45) Air Hose
- 1pc - Adaptor
- 1pc - Holder
- 1pc - 2c.c. Cup
- 1pc - 8c.c. Cup
- 1pc - Spanner



SR-2101

AIR BRUSH SET

40 pieces in one carton

Contents 4 pcs

- 1pc - Air Brush
- 1pc - Pipette
- 1pc - Spanner
- 1pc - Air Adaptor



SC-005

BALL JOINT & TIE-ROD SPLITTER SET

10 pieces in one carton

Contents 5 pcs

- 1pc - Air Hammer Adapter
- 1pc - 1-1/8"(28.57mm) Pitman Arm
- 1pc - Striking Handle
- 1pc - 11/16"(17.46mm) Tie Rod
- 1pc - 15/16"(23.81mm) Ball Joint



SE-1025

FLEXIBLE LED LIGHT

20 pieces in one carton



SE-2012

LED WORK LIGHT

24 pieces in one carton



SE-3001

LED HEADLAMP

50 pieces in one carton



SQ-0217

AIR POWERED BRAKE CALIIPER WIND BACK TOOL-SET 17PCS



5 pieces in one carton

Air inlet 1/4"

- Not available in north America

Contents 17 pcs

- 1pc - Air Powered Brake Caliper Wind Back Tool
- 16pcs - Disk



SANDBLASTING GUN

SANDBLASTING GUN

SX-1201 AIR UNDERSEAL GUN



20 pieces in one carton



SX-1615 AIR CLEANING GUN



8 pieces in one carton



SX-1618 AIR CLEANING GUN KIT



8 pieces in one carton



SX-2101 AIR TWISTER GUN



Not available in north America



SX-3101 AIR SANDBLASTING GUN



20 pieces in one carton



SX-3102 AIR SANDBLASTING GUN



20 pieces in one carton



SX-3103 AIR SANDBLASTING GUN



10 pieces in one carton



SX-3111 AIR UNDERSEAL GUN



20 pieces in one carton



SX-3112 AIR UNDERSEAL GUN



50 pieces in one carton



SX-3202 SOLVENT / CLEANER SPRAY GUN



20 pieces in one carton



SX-3203 1L CLEANING GUN



10 pieces in one carton



SX-3301 AIR SOLVENT CLEANER SPRAY GUN



20 pieces in one carton



SX-4101 SODA BLASTER



10 pieces in one carton



Item No.	Cup Capacity	No Load Speed	Overall Length	Avg. Air Consumption	Air Pressure	Net Weight		Air Hose	Sound Pressure	Air Inlet
	L	R.P.M	inch(mm)	CFM (L/min)	PSI (bar)	LBS	kg	Inch	dBA	Inch
SX-1201	---	---	9-9/16"(245)	6.2	90(6.3)	1.4	0.7	3/8"	---	1/4"
SX-1615	1.0	---	11-7/16"(290)	5.0(141.5)	90(6.3)	0.9	0.4	3/8"	85.0	1/4"
SX-1618	---	---	14-15/16"(380)	5	90(6.3)	0.4	0.2	3/8"	---	1/4"
SX-2101	1.0	5500	8-7/32"x4-5/16"(210x110)	2.0(56.6)	90(6.3)	1.7	0.8	3/8"	85.0	1/4"
SX-3101	1.0	---	11"(280)	4.3(121.8)	90(6.3)	1.3	0.6	3/8"	85.0	1/4"
SX-3102	0.7	---	10-1/8"(260)	4.0(113.3)	90(6.3)	0.8	0.4	3/8"	85.0	1/4"
SX-3103	---	---	122"(3100)	3.5(99.1)	90(6.3)	2.3	1.1	3/8"	80.0	1/4"
SX-3111	1.0	---	10-1/8"(260)	3.0(84.9)	90(6.3)	1.0	0.4	3/8"	85.0	1/4"
SX-3112	---	---	10-1/8"(260)	3.0(84.9)	90(6.3)	0.5	0.2	3/8"	85.0	1/4"
SX-3202	1.0	---	20-13/16"(530)	1.0(56.6)	90(6.3)	1.0	0.5	3/8"	65.0	1/4"
SX-3203	1.0	---	18-1/2"(470)	1.0(56.6)	90(6.3)	1.2	0.5	3/8"	65.0	1/4"
SX-3301	1.0	---	11-13/16"(300)	10(300)	90(6.3)	1.5	0.7	1/4"	85.0	1/4"
SX-4101	0.6	---	7-3/4"(197)	8.0(226.5)	90(6.3)	0.8	0.4	3/8"	82.0	1/4"

FILTER REGULATOR LUBRICTOR

SV-1240
FILTER, REGULATOR



SV-1260
FILTER, REGULATOR



SV-1360
FILTER, REGULATOR



SV-1460
FILTER, REGULATOR



SV-1660
FILTER, REGULATOR



SV-1860
FILTER, REGULATOR



SV-2220
FILTER, REGULATOR,
LUBRICATOR



SV-2260
FILTER, REGULATOR,
LUBRICATOR



SV-2280
FILTER, REGULATOR,
LUBRICATOR



SV-2360
FILTER, REGULATOR,
LUBRICATOR



SV-2380
FILTER, REGULATOR,
LUBRICATOR



SV-2431
FILTER, REGULATOR,
LUBRICATOR



Item No.	Air in / outlet	Max Input Pressure	Max Output Pressure	Max.Flow	Working Temperature	Drain Capacity	Oil Capacity	Filter Element
	inch	PSI	PSI	L/min	°C	ml	ml	μ(micro)
SV-1240	1/4"	150	145	1100	5-60°	15	---	5μ
SV-1260	1/4"	215	145	1750	5-60°	80	---	5μ
SV-1360	3/8"	215	145	2500	5-60°	80	---	5μ
SV-1460	1/2"	215	145	3000	5-60°	80	---	5μ
SV-1660	3/4"	250	225	4600	5-60°	300	---	5μ
SV-1860	1"	250	225	5200	5-60°	300	---	5μ
SV-2220	1/4"	150	70-140	1100	5-60°	15	30	5μ
SV-2260	1/4"	215	70-150	1750	5-60°	80	150	5μ
SV-2280	1/4"	250	70-140	1750	5-60°	80	150	5μ
SV-2360	3/8"	215	7-150	2500	5-60°	80	150	5μ
SV-2380	3/8"	250	70-140	2500	5-60°	80	150	5μ
SV-2431	1/2"	285	70-140	3400	5-60°	80	200	5μ

FILTER REGULATOR LUBRICATOR

FILTER REGULATOR LUBRICTOR

FILTER REGULATOR LUBRICTOR

SV-2460
FILTER, REGULATOR,
LUBRICTOR



SV-2660
FILTER, REGULATOR,
LUBRICTOR



SV-2860
FILTER, REGULATOR,
LUBRICTOR



SV-3260
FILTER, REGULATOR,
LUBRICTOR



SV-3360
FILTER, REGULATOR,
LUBRICTOR



SV-3460
FILTER, REGULATOR,
LUBRICTOR



SV-3660
FILTER, REGULATOR,
LUBRICTOR



SV-3860
FILTER, REGULATOR,
LUBRICTOR



SW-12(1/4")
MINI LUBRICATOR



SW-13(3/8")
MINI LUBRICATOR



Item No.	Air in / outlet	Max Input Pressure	Max Output Pressure	Max.Flow	Working Temperature	Drain Capacity	Oil Capacity	Filter Element
	inch	PSI	PSI	L/min	°C	ml	ml	μ(micro)
SV-2460	1/2"	250	7-215	4000	5-60°	80	150	5μ
SV-2660	3/4"	250	225	4600	5-60°	300	300	5μ
SV-2860	1"	250	225	5200	5-60°	300	300	5μ
SV-3260	1/4"	215	70-150	1750	5-60°	80	150	5μ
SV-3360	3/8"	215	70-150	2500	5-60°	80	150	5μ
SV-3460	1/2"	250	7-215	4000	5-60°	80	150	5μ
SV-3660	3/4"	250	225	4600	5-60°	300	350	5μ
SV-3860	1"	250	225	5200	5-60°	300	350	5μ

AIR HOSE REEL

SA-2015

AIR HOSE REEL
Case Material : Steel

2 pieces in one carton



SA-3215

AIR HOSE REEL
Case Material : Shock-Proof Plastic

2 pieces in one carton



SA-3315

AIR HOSE REEL
Case Material : Shock-Proof Plastic

2 pieces in one carton



SD-22

8 x 12 AIR HOSE



SD-23

POLYURETHANE RECOIL AIR-HOSE

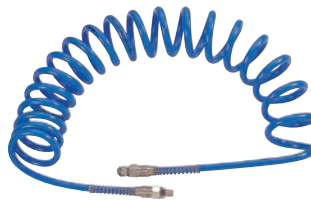

SD-24

POLYURETHANE RECOIL AIR-HOSE

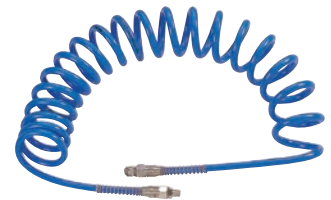

Item No.	Hose Inside Diameter	Hose Outside Diameter	Hose Length	Working Pressure	Maximum Pressure	Male PT Fitting	Weight
	mm	mm	M	PSI(bar)	PSI(bar)	inch	kg
SA-2015	8.0	12.0	15	101.5(7.0)	284.4(17.8)	1/4"	6.2
SA-3215	8.0	12.0	15	90(6.3)	300(20.7)	1/4"	5.0
SA-3315	10.0	15.0	15	90(6.3)	300(20.7)	3/8"	6.0
SD-22107	8.0	12.0	7.5	101.5(7.0)	284.4(17.8)	1/4"	0.8
SD-22115	8.0	12.0	15	101.5(7.0)	284.4(17.8)	1/4"	1.4
SD-22130	8.0	12.0	30	101.5(7.0)	284.4(17.8)	1/4"	2.6
SD-23110	8.0	12.0	10	101.5(7.0)	284.4(17.8)	1/4"	0.8
SD-23115	8.0	12.0	15	101.5(7.0)	284.4(17.8)	1/4"	1.2
SD-23210	5.0	8.0	10	101.5(7.0)	284.4(17.8)	1/4"	0.4
SD-23215	5.0	8.0	15	101.5(7.0)	284.4(17.8)	1/4"	0.6
SD-23315	10	15.0	15	101.5(7.0)	284.4(17.8)	3/8"	1.9
SD-24415	13	18.0	15	101.5(7.0)	284.4(17.8)	1/2"	2.1

TORQUE WRENCH

★★ TE-81N/TE-82N TE-83N/TE-84N/TE-85N 1" TORQUE WRENCH, ENGRAVE. NM / FT-LB SCALE



2 pieces in one carton
TE-81N/TE-82N

1 pieces in one carton
TE-83N/TE-84N/TE-85N

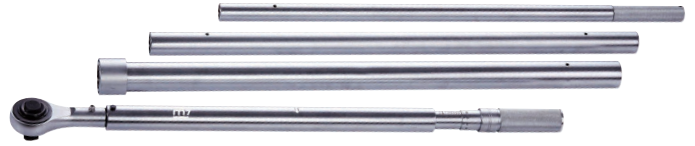

Item No.	Drive	Gear	Torque Range	Indicator	Torque Adjusting	D	H	L	Weight
	Inch	T	ft-lb(Nm)			mm	mm	mm	kg
TE-815080N	1"	24	129-572(150-180)	Engraved	Rotating	---	---	1240	6.1
TE-820100N	1"	24	166-719(200-1000)	Engraved	Rotating	70.2	72.1	1240	6.4
TE-830150N	1"	24	258-1070(300-1500)	Engraved	Rotating	---	---	1850	10.6
TE-840200N	1"	36	369-1402(400-2000)	Engraved	Rotating	---	---	2300	18.3
TE-850250N	1"	36	443-1771(500-2500)	Engraved	Rotating	74.5	66.1	2755	19.6

★★ TM-0416 TM-0418 TORQUE MULTIPLIER

2 pieces in one carton

- Works with high transmission efficiency by planet gears
- 5:1 torque multiplication
- Multiplication accuracy ±5%
- Supplied with 2 reaction bar styles



★★ TM-0428-1 TM-0428-2 TORQUE MULTIPLIER

1 pieces in one carton

- Multiplication deviation less than ±5%
- Mechanism with high ratio gearbox 26:1
- High ratios offer benefits without using long lever arms or heavy wrenches
- Supplied with 2 different reaction bar
- Durable construction without maintenance necessary and long lifetime



★★ TM-0618 TORQUE MULTIPLIER

2 pieces in one carton

- Planetary gear carrier mechanism makes high transmission efficiency and load capacity.
- 5:1 torque multiplication.
- Multiplication accuracy ±5%.
- Supplied with 2 reaction bars.



Item No.	Input Square	Output Square	Max Rated Output	Ratio	Net Weight	
	Inch	Inch	ft-lb(Nm)		LBS	kg
TM-0416	1/2"	3/4"	1100(1500)	5:1	14.2	6.5
TM-0418	1/2"	1"	1100(1500)	5:1	14.2	6.5
TM-0428-1	1/2"	1"	2200(3000)	15.5:1	25.4	11.5
TM-0428-2	1/2"	1"	3300(4500)	26:1	28.7	13
TM-0618	3/4"	1"	2000(2700)	5:1	14.2	6.5

★★ PROFESSIONAL SERISE TORQUE WRENCH WINDOW DISPLAY. Nm / ft-lb scale, Back Turning TW-210222/TW-310552/TW-411102/TW-412202

24 pieces in one carton

24 pieces in one carton

12 pieces in one carton

12 pieces in one carton



★★ CLASSIC SERIES TORQUE WRENCH TE-205025N/TE-225250N/TE-305025N/TE-320110N/TE-442210N TE-428210N/TE-450350N

1/2" TORQUE WRENCH, 42-210 Nm, Engraved Nm / ft-lb scale



24 pieces in one carton
TE-205025N/TE-225250N
TE-305025N

12 pieces in one carton
TE-320110N/TE-442210N
TE-428210N/TE-450350N



TORQUE WRENCH

☆☆ MICRO-ADJUSTABLE TORQUE WRENCH SERIES

TB-205025N/TB-305025N/TB-320110N/TB-420210N/TB-450350N TB-610060N/TB-615080N/TB-620100N

24 pieces in one carton
TB-205025N/TB-305025N

12 pieces in one carton
TB-320110N

10 pieces in one carton
TB-450350N

2 pieces in one carton
TB-610060N/TB-615080N/TB-620100N



☆☆ PROFESSIONAL REVERSIBLE SERIES TORQUE WRENCH

TD-202025/TD-305050/TD-410100/TD-420200/TD-610060

24 pieces in one carton
TD-202025/TD-305050

12 pieces in one carton
TD-410100/TD-420200

2 pieces in one carton
TD-610060



☆☆ PROFESSIONAL SERIES TORQUE WRENCH

TW-611602/TW-611802/TW-612102

3/4" TORQUE WRENCH, WINDOW DISPLAY. Nm / ft-lb scale, Back Turning

2 pieces in one carton



Item No.	Drive	Gear	Torque Range			Indicator	Torque Adjusting	D	H	L	Weight
	Inch	T	Nm	ft-lb	in-lb			mm	mm	mm	kg
TW-210222	1/4"	24	2-25	1.5-18	---	Magnifying glass	Back Turning	28.0	23	296	0.4
TW-310552	3/8"	24	5-50	3.5-37	---	Magnifying glass	Back Turning	28.0	28	333	0.5
TW-411102	1/2"	32	10-100	8-75	---	Magnifying glass	Back Turning	40.5	40	400	0.8
TW-412202	1/2"	32	20-200	10-150	---	Magnifying glass	Back Turning	40.5	40	500	1.3
TE-205025N	1/2"	24	5-25	---	53.1-212.4	Engraved	Rotating	32	31.8	275	0.6
TE-225250N	1/4"	24	2.8-28.2	---	25-250	Engraved	Rotating	32	31.8	275	0.6
TE-305025N	3/8"	24	5-25	---	53.1-212.4	Engraved	Rotating	32	31.8	370	0.8
TE-320110N	3/8"	24	20-110	14.8-81.1	---	Engraved	Rotating	32	31.8	370	0.8
TE-442210N	1/2"	24	42-210	30.6-155	---	Engraved	Rotating	46.3	33	450	1.3
TE-428210N	1/2"	24	28-210	20.7-154.9	---	Engraved	Rotating	46.3	33	570	1.7
TE-450350N	1/2"	24	50-350	36.9-258.1	---	Engraved	Rotating	46.3	33	450	1.3
TB-205025N	1/4"	24	5-25	---	53.1-212.4	Engraved	Rotating	32	31.8	281	0.5
TB-305025N	3/8"	24	5-25	---	53.1-212.4	Engraved	Rotating	32	31.8	361	0.8
TB-320110N	3/8"	24	20-110	18.5-77.5	---	Engraved	Rotating	32	31.8	361	0.8
TB-420210N	1/2"	24	20-210	18.4-151.2	---	Engraved	Rotating	40.5	40	461	1.3
TB-450350N	1/2"	24	50-350	48.0-247.2	---	Engraved	Rotating	40.5	40	553	1.6
TB-610060N	3/4"	24	100-600	92.0-424	---	Engraved	Back Turning	63	58	1010	4.7
TB-615080N	3/4"	24	150-800	129-572	---	Engraved	Rotating	63	58	1010	2.4
TB-620100N	3/4"	24	200-1000	166-719	---	Engraved	Back Turning	63	58	1200	6.0
TD-202025	1/4"	72	2-25	1.5-1.8	---	Magnifying glass	Back Turning	40.5	40	298	0.4
TD-305050	3/8"	72	5-50	3.5-37	---	Magnifying glass	Back Turning	40.5	40	363	0.5
TD-410100	1/2"	72	10-100	8-75	---	Magnifying glass	Back Turning	40.5	40	445	1.1
TD-420200	1/2"	72	20-200	10-150	---	Magnifying glass	Back Turning	40.5	40	513	1.3
TD-610060	3/4"	72	100-600	75-440	---	Magnifying glass	Back Turning	40.5	40	1040	4.7
TW-611602	3/4"	24	100-600	75-440	---	Magnifying glass	Back Turning	63	58.5	1040	4.7
TW-611802	3/4"	24	150-800	110-590	---	Magnifying glass	Back Turning	63	58.5	1240	5.5
TW-612102	3/4"	24	200-1000	150-740	---	Magnifying glass	Back Turning	63	58.5	1240	5.5

TORQUE WRENCH

CLASSIC SERIES TORQUE WRENCH

TF-310080N/TF-430250N

3/8" & 1/2" DRIVE FLEX-HEAD TORQUE WRENCH

12 pieces in one carton



SPLIT-BEAM SERIES TORQUE WRENCH

TS-320100N/TS-440250N

3/8" & 1/2" DRIVE FLEXIBLE SPLIT-BEAM TORQUE WRENCH

12 pieces in one carton 10 pieces in one carton



TI-2105025 KIT NEW

Interchangeable Torque Wrench Tool

1 pieces in one carton

- 1pc - Torque Wrench 5~25Nm / 53.1~212.4 IN-LB
- 1pc - Open ended Insert tool: 10mm,13mm,17mm
- 1pc - Ring Insert tool: 10mm,13mm,17mm
- 1pc - 1/4"DR. 72T ratchet Insert tool



TI-4204020 KIT NEW

Interchangeable Torque Wrench Tool

1 pieces in one carton

- 1pc - Torque Wrench 40~200Nm
- 1pc - Open ended Insert tool: 13mm,14mm,15mm,17mm,19mm,22mm,24mm,27mm,30mm
- 1pc - 1/2"DR. 72T ratchet Insert tool



Item No.	Drive	Gear	Torque Range	Indicator	Torque Adjusting	D	H	L	Weight
	Inch	T	ft-lb			mm	mm	mm	kg
TF-310080N	3/8"	32	10-80	Engraved	Rotating	36.8	30.4	465	11.1
TF-430250N	1/2"	32	30-250	Engraved	Rotating	43.3	40.5	640	1.9
TS-320100N	3/8"	32	20-100	Engraved	Flexible	35.2	27.8	476	1.0
TS-440250N	1/2"	32	40-250	Engraved	Flexible	44.1	36.1	590	1.7

DIGITAL TORQUE WRENCH

★★ **GTA-201030**

1/4" DIGITAL ANGLE TORQUE WRENCH Accuracy : clockwise +/- 1.5% counterclockwise +/- 2.5%

8 pieces in one carton



★★ **GTA-306135**

3/8" DIGITAL ANGLE TORQUE WRENCH Accuracy : clockwise +/- 1.5% counterclockwise +/- 2.5%

6 pieces in one carton



★★ **GTA-406135**

1/2" DIGITAL ANGLE TORQUE WRENCH Accuracy : clockwise +/- 1.5% counterclockwise +/- 2.5%

6 pieces in one carton



★★ **GTA-410200**

1/2" DIGITAL ANGLE TORQUE WRENCH Accuracy : clockwise +/- 1.5% counterclockwise +/- 2.5%

4 pieces in one carton



★★ **GTA-417340**

1/2" DIGITAL ANGLE TORQUE WRENCH Accuracy : clockwise +/- 1.5% counterclockwise +/- 2.5%

4 pieces in one carton



★★ **GTA-606060**

3/4" DIGITAL ANGLE TORQUE WRENCH Accuracy : clockwise +/- 1.5% counterclockwise +/- 2.5%

1 pieces in one carton



★★ **GTA-610100**

3/4" DIGITAL ANGLE TORQUE WRENCH Accuracy : clockwise +/- 1.5% counterclockwise +/- 2.5%

1 pieces in one carton













★★ **GTA-810100**

1" DIGITAL ANGLE TORQUE WRENCH Accuracy : clockwise +/- 1.5% counterclockwise +/- 2.5%

1 pieces in one carton



Item No.	Drive	Gear	Torque Range		Indicator	Torque Adjusting	D	H	L	Weight
	Inch	T	Nm	ft-lb	LCD		mm	mm	mm	kg
GTA-201030					LCD					
GTA-306135	1/4"	72	1.5-30	1.11-22.13	LCD	Digital	38	40	410	0.7
GTA-306135	3/8"	72	6.8-135	5.0-99.6	LCD	Digital	38	40	432	0.8
GTA-406135	1/2"	72	6.8-135	5.0-99.6	LCD	Digital	38	40	454	1.1
GTA-410200	1/2"	72	10-200	7.4-147.5	LCD	Digital	38	40	566	1.2
GTA-417340	1/2"	72	17-340	12.5-250.8	LCD	Digital	38	40	666	1.4
GTA-606060	3/4"	24	60-600	44.3-442.5	LCD	Digital	63	60	943	3.8
GTA-610100	3/4"	24	100-1000	73.8-737.6	LCD	Digital	63	60	1235	4.8
GTA-810100	1"	24	100-1000	73.8-737.6	LCD	Digital	70	70	1235	5.1

DIGITAL TORQUE WRENCH

DIGITAL TORQUE WRENCH

DIGITAL TORQUE WRENCH

★★ **GTB-201030**

1/4" DIGITAL FLEXIBLE & ANGLE TORQUE WRENCH

8 pieces in one carton

Accuracy : clockwise +/- 2% counterclockwise +/- 3%



★★ **GTB-306135**

3/8" DIGITAL FLEXIBLE & ANGLE TORQUE WRENCH

6 pieces in one carton

Accuracy : clockwise +/- 2% counterclockwise +/- 3%



★★ **GTB-410200**

1/2" DIGITAL FLEXIBLE & ANGLE TORQUE WRENCH

4 pieces in one carton

Accuracy : clockwise +/- 2% counterclockwise +/- 3%



★★ **GTB-417340**

1/2" DIGITAL FLEXIBLE & ANGLE TORQUE WRENCH

4 pieces in one carton

Accuracy : clockwise +/- 2% counterclockwise +/- 3%



★★ **GTF-203030**

1/4" DIGITAL FLEXIBLE TORQUE WRENCH

8 pieces in one carton

Accuracy : clockwise +/- 2% counterclockwise +/- 3%



★★ **GTF-313135**

3/8" DIGITAL FLEXIBLE TORQUE WRENCH

6 pieces in one carton

Accuracy : clockwise +/- 2% counterclockwise +/- 3%



★★ **GTF-420200**

1/2" DIGITAL FLEXIBLE TORQUE WRENCH

4 pieces in one carton

Accuracy : clockwise +/- 2% counterclockwise +/- 3%



★★ **GTF-434340**

1/2" DIGITAL FLEXIBLE TORQUE WRENCH

4 pieces in one carton

Accuracy : clockwise +/- 2% counterclockwise +/- 3%



Item No.	Drive	Gear	Torque Range		Indicator	Torque Adjusting	D	H	L	Weight
	Inch	T	Nm	ft-lb	LCD		mm	mm	mm	kg
GTB-201030	1/4"	72	3-30	2.22-22.13	LCD	Digital	38	38	413	0.7
GTB-306135	3/8"	72	13.5-135	10-99.6	LCD	Digital	38	38	446	0.9
GTB-410200	1/2"	72	20-200	14.8-147.5	LCD	Digital	38	41	572	1.3
GTB-417340	1/2"	72	34-340	25-250	LCD	Digital	38	41	670	1.4
GTF-203030	1/4"	72	3-30	2.22-22.13	LCD	Digital	38	38	446	0.7
GTF-313135	3/8"	72	13.5-135	10-99.6	LCD	Digital	38	38	446	0.9
GTF-420200	1/2"	72	20-200	14.8-147.5	LCD	Digital	38	41	572	1.3
GTF-434340	1/2"	72	34-340	25-250	LCD	Digital	38	41	670	1.4

★★  **GMS-203006/GMS-207015/GMS-212025**

1/4" MINI DIGITAL TORQUE WRENCH (SQUARE) Accuracy : clockwise +/- 3% counterclockwise +/- 4%

10 pieces in one carton



★★  **GMD-205050/GMD-210200/GMD-220400**

1/4" MINI DIGITAL TORQUE SCREWDRIVER (BIT) Accuracy : clockwise +/- 3% counterclockwise +/- 4%



★★  **GMI-206006/GMI-215015/GMI-225025**

1/4" MINI DIGITAL INTERCHANGEABLE TORQUE WRENCH Accuracy : clockwise +/- 3% counterclockwise +/- 4%



★★  **GTW-930/GTW-940/GTW-941**

3/8" / 1/2" / 1/2" DIGITAL TORQUE ADAPTER

Accuracy : clockwise +/- 1.5% counterclockwise +/- 2.5%

10 pieces in one carton













★★  **GTA-930/GTA-940/GTA-941**

3/8" / 1/2" / 1/2" DIGITAL ANGLE TORQUE ADAPTER

Accuracy : clockwise +/- 1.5% counterclockwise +/- 2.5%

10 pieces in one carton



Item No.	Drive	Gear	Torque Range		Indicator	Torque Adjusting	D	H	L	Weight
	Inch	T	Nm	ft-lb			mm	mm	mm	kg
										
GMS-203006	1/4"	72	0.3-6	0.221-4.424	LCD	Digital	27	27	244	0.2
GMS-207015	1/4"	72	0.75-15	0.554-11.07	LCD	Digital	27	27	244	0.2
GMS-212025	1/4"	72	1.25-25	0.923-18.45	LCD	Digital	27	27	244	0.2
GMD-205050	1/4"(BIT)	---	0.05-0.5	0.036-0.368	LCD	Digital	28	28	234	0.2
GMD-210200	1/4"(BIT)	---	0.1-2	0.0737-1.47	LCD	Digital	28	28	234	0.2
GMD-220400	1/4"(BIT)	---	0.2-4	0.147-2.95	LCD	Digital	28	28	234	0.2
GMI-206006	1/4"	72	0.6-6	0.442-4.424	LCD	Digital	27	27	255	2.5
GMI-215015	1/4"	72	1.5-15	1.108-11.07	LCD	Digital	27	27	255	2.5
GMI-225025	1/4"	72	2.5-25	1.846-18.45	LCD	Digital	27	27	255	2.5
GTW-930	3/8"	---	6.8-135	5.0-99.6	LCD	Digital	42	39	75	0.2
GTW-940	1/2"	---	10-200	7.4-147.5	LCD	Digital	42	39	75	0.2
GTW-941	1/2"	---	17-340	12.5-250.8	LCD	Digital	42	39	75	0.2
GTA-930	3/8"	---	6.8-135	5.0-99.6	LCD	Digital	50	39	75	0.2
GTA-940	1/2"	---	10-200	7.4-147.5	LCD	Digital	50	39	75	0.2
GTA-941	1/2"	---	17-340	12.5-250.8	LCD	Digital	50	39	75	0.2

DIGITAL TORQUE WRENCH

DIGITAL TORQUE WRENCH

★★ **GTW-201030**
1/4" DIGITAL TORQUE WRENCH Accuracy : clockwise +/- 1.5% counterclockwise +/- 2.5%
 8 pieces in one carton



★★ **GTW-306135**
3/8" DIGITAL TORQUE WRENCH Accuracy : clockwise +/- 1.5% counterclockwise +/- 2.5%
 6 pieces in one carton



★★ **GTW-406135**
1/2" DIGITAL TORQUE WRENCH Accuracy : clockwise +/- 1.5% counterclockwise +/- 2.5%
 6 pieces in one carton



★★ **GTW-410200**
1/2" DIGITAL TORQUE WRENCH Accuracy : clockwise +/- 1.5% counterclockwise +/- 2.5%
 4 pieces in one carton



★★ **GTW-417340**
1/2" DIGITAL TORQUE WRENCH Accuracy : clockwise +/- 1.5% counterclockwise +/- 2.5%
 4 pieces in one carton



★★ **GTW-606060**
3/4" DIGITAL TORQUE WRENCH Accuracy : clockwise +/- 1.5% counterclockwise +/- 2.5%
 1 pieces in one carton



★★ **GTW-610100**
3/4" DIGITAL TORQUE WRENCH Accuracy : clockwise +/- 1.5% counterclockwise +/- 2.5%
 1 pieces in one carton



★★ **GTW-810100**
1" DIGITAL TORQUE WRENCH Accuracy : clockwise +/- 1.5% counterclockwise +/- 2.5%
 1 pieces in one carton



Item No.	Drive	Gear	Torque Range		Indicator	Torque Adjusting	D	H	L	Weight
	Inch	T	Nm	ft-lb	LCD	Digital	mm	mm	mm	kg
GTW-201030	1/4"	72	1.5-30	1.11-22.13	LCD	Digital	38	40	410	0.7
GTW-306135	3/8"	72	6.8-135	5.0-99.6	LCD	Digital	38	40	432	0.8
GTW-406135	1/2"	72	6.8-135	5.0-99.6	LCD	Digital	38	40	455	1.1
GTW-410200	1/2"	72	10-200	20.7-154.9	LCD	Digital	38	40	566	1.2
GTW-417340	1/2"	72	17-340	12.5-250.8	LCD	Digital	38	40	662	1.4
GTW-606060	3/4"	24	60-600	44.3-442.5	LCD	Digital	63	60	943	3.8
GTW-610100	3/4"	24	100-1000	73.8-737.6	LCD	Digital	63	60	1235	4.6
GTW-810100	1"	24	100-1000	73.8-737.6	LCD	Digital	70	70	1235	4.9

★★★  **GBI-403030 NEW**

1/2" Bluetooth Rechargeable Digital Torque Wrench

6 pieces in one carton Accuracy : clockwise +/- 1.5% counterclockwise +/- 2.5%

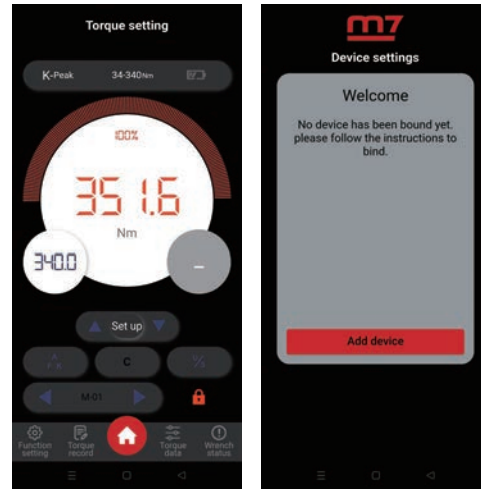

▲ Mobile app mockup

★★★  **GBI-406060 NEW**

1/2" Bluetooth Rechargeable Digital Torque Wrench

6 pieces in one carton Accuracy : clockwise +/- 2% counterclockwise +/- 3%

★★★  **GBI-434340 NEW**

1/2" Bluetooth Rechargeable Digital Torque Wrench

4 pieces in one carton Accuracy : clockwise +/- 2% counterclockwise +/- 3%

- Bluetooth app allows the transmission and assessment of torque values to be faster and more immediate.
- Interchangeable torque head for different workstations.
- Adjustable torque values for 4 types.



Apple Store



Google Play



LED operation display panel.

USB charging (Type C).

★★★  **GDI-403030 NEW**

1/2" Interchangeable Digital Torque Wrench

6 pieces in one carton Accuracy : clockwise +/- 2% counterclockwise +/- 3%



★★★  **GDI-406060 NEW**

1/2" Interchangeable Digital Torque Wrench

6 pieces in one carton Accuracy : clockwise +/- 2% counterclockwise +/- 3%



★★★  **GDI-434340 NEW**

1/2" Interchangeable Digital Torque Wrench

4 pieces in one carton Accuracy : clockwise +/- 2% counterclockwise +/- 3%



Item No.	Drive	Gear	Torque Range		Indicator	Torque Adjusting	D	H	L	Weight
	Inch	T	Nm	ft-lb	LCD		mm	mm	mm	kg
GBI-403030	1/2"	72	3-30	2.22-22.13	LCD	Digital	38	40	435	1.1
GBI-406060	1/2"	72	6-60	4.4-44.3	LCD	Digital	38	40	435	1.1
GBI-434340	1/2"	72	34-340	25-250	LCD	Digital	38	40	644	1.4
GDI-403030	1/2"	72	3-30	2.22-22.13	LCD	Digital	38	40	435	1.1
GDI-406060	1/2"	72	6-60	4.4-44.3	LCD	Digital	38	40	435	1.1
GDI-434340	1/2"	72	34-340	25-250	LCD	Digital	38	40	644	1.4

IMPACT SOCKET

MB34012S

IMPACT SOCKET SET

12pcs 3/8" Drive Inch Size

12 pieces in one carton

- Contents : 5/16", 3/8", 7/16", 1/2", 9/16", 5/8", 11/16", 3/4", 13/16", 7/8", 15/16", 1"



MB34013M

IMPACT SOCKET SET

13pcs 3/8" Drive Metric Size

12 pieces in one carton

- Contents : 6mm, 8mm, 9mm, 10mm, 11mm, 12mm, 13mm, 14mm, 15mm, 16mm, 17mm, 18mm, 19mm



MB42011M

STD IMPACT SOCKET SET

11pcs 1/2" Drive Metric size

6 pieces in one carton

- Contents : 10mm, 11mm, 13mm, 17mm, 19mm, 22mm, 24mm, 27mm, 29mm, 30mm, 32mm



MB44013S

IMPACT SOCKET SET

13pcs 1/2" Drive Inch Size

6 pieces in one carton

- Contents : 7/16", 1/2", 9/16", 5/8", 11/16", 3/4", 13/16", 7/8", 15/16", 1", 1-1/16", 1-1/8", 1-1/4"



MB44014M

IMPACT SOCKET SET

14pcs 1/2" Drive Metric Size

8 pieces in one carton

- Contents : 10mm, 11mm, 12mm, 13mm, 14mm, 15mm, 16mm, 17mm, 18mm, 19mm, 21mm, 22mm, 26mm, 27mm



MB61008M

IMPACT SOCKET SET

8pcs 3/4" Drive

4 pieces in one carton

- Contents : M21, M22, M23, M24, M27, M30, M32, M36, M41



MB61016M

STD IMPACT SOCKET SET

16pcs 3/4" Drive

2 pieces in one carton

- Contents : M19, M21, M22, M24, M27, M28, M29, M30, M32, M33, M35, M36, M38, M41, M46, M50



MB62010M

IMPACT SOCKET SET

10pcs 3/4" Drive

4 pieces in one carton

- Contents : 19mm, 22mm, 24mm, 27mm, 30mm, 32mm, 36mm, 38mm, 40mm, 42mm



MB64008M

IMPACT SOCKET SET

8pcs 3/4" Drive Metric Size

4 pieces in one carton

- Contents : 26mm, 27mm, 29mm, 30mm, 32mm, 33mm, 35mm, 36mm



MB64008M1

IMPACT SOCKET SET

8PCS 3/4" Drive

6 pieces in one carton

- Contents : 21mm, 23mm, 24mm, 27mm, 30mm, 32mm, 36mm, 41mm



MB64008S

IMPACT SOCKET SET

8pcs 3/4" Drive Inch Size

4 pieces in one carton

- Contents : 1", 1-5/16", 1-1/16", 1-3/8", 1-1/8", 1-7/16", 1-1/4", 1-1/2"



MB64008SP

IMPACT SOCKET SET

8pcs 3/4" Drive Inch Size

4 pieces in one carton

- Contents : 3/4", 7/8", 15/16", 1-1/16", 1-3/16", 1-1/4", 1-7/16", 1-1/2"



MB35012S

IMPACT SOCKET SET

12pcs 3/8" Drive Inch Size Deep

8 pieces in one carton

- Contents : 5/16", 3/8", 7/16", 1/2", 9/16", 5/8", 11/16", 3/4", 13/16", 7/8", 15/16", 1"



MB35013M

DEEP IMPACT SOCKET SET

13pcs 3/8" Drive Metric Size

8 pieces in one carton

- Contents : 6mm, 8mm, 9mm, 10mm, 11mm, 12mm, 13mm, 14mm, 15mm, 16mm, 17mm, 18mm, 19mm



MB43015M

DEEP IMPACT SOCKET SET

15pcs 1/2" Drive Metric Size

6 pieces in one carton

- Contents : 10mm, 11mm, 12mm, 13mm, 14mm, 15mm, 16mm, 17mm, 19mm, 21mm, 22mm, 24mm, 27mm, 30mm, 32mm



MB45010M

DEEP IMPACT SOCKET SET

10pcs 1/2" Drive Metric Size

6 pieces in one carton

- Contents : 10mm, 12mm, 13mm, 14mm, 15mm, 17mm, 19mm, 21mm, 24mm, 27mm



MB45013S

DEEP IMPACT SOCKET SET

13pcs 1/2" Drive Inch Size

4 pieces in one carton

- Contents : 7/16", 1/2", 9/16", 5/8", 11/16", 3/4", 13/16", 7/8", 15/16", 1", 1-1/16", 1-1/8", 1-1/4"



MB45014M

DEEP IMPACT SOCKET SET

14pcs 1/2" Drive Metric Size

4 pieces in one carton

- Contents : 10mm, 11mm, 12mm, 13mm, 14mm, 15mm, 16mm, 17mm, 18mm, 19mm, 21mm, 22mm, 26mm, 27mm



MB63008M

DEEP IMPACT SOCKET SET

8pcs 3/4" Drive

3 pieces in one carton

- Contents : M21, M22, M24, M27, M30, M32, M36, M41



MB63008S

IMPACT SOCKET SET

8pcs 3/4" Drive Inch Size

3 pieces in one carton

- Contents : 1-1/16", 1-1/8", 1-1/4", 1-5/16", 1-3/8", 1-7/16", 1-1/2"



MB65008M

DEEP IMPACT SOCKET SET

8pcs 3/4" Drive Metric Size

4 pieces in one carton

- Contents : 26mm, 27mm, 29mm, 30mm, 32mm, 33mm, 35mm, 36mm



MB65008M1

DEEP IMPACT SOCKET SET

8pcs 3/4" Drive Metric Size

4 pieces in one carton

- Contents : 21mm, 23mm, 24mm, 27mm, 30mm, 32mm, 36mm, 41mm



MB65008S

DEEP IMPACT SOCKET SET

8pcs 3/4" Drive Inch Size

2 pieces in one carton

- Contents : 1", 1-1/16", 1-1/8", 1-1/4", 1-5/16", 1-3/8", 1-7/16", 1-1/2"



MB65008S1

DEEP IMPACT SOCKET SET

8pcs 3/4" Drive Inch Size

2 pieces in one carton

- Contents : 3/4", 7/8", 15/16", 1", 1-1/16", 1-1/8", 1-3/16", 1-1/4"



IMPACT SOCKET

MB85008M

DEEP SOCKET SET

8pcs 1" Drive

2 pieces in one carton

- Contents : 27mm, 30mm, 32mm, 36mm, 38mm, 41mm, 46mm, 50mm



MB81009M/S

STD SOCKET SET

9pcs 1" Drive

2 pieces in one carton

- Contents : 27mm, 30mm, 32mm, 35mm, 36mm, 38mm, 41mm, 46mm, 50mm



MB46008R

STAR BIT SOCKET SET

8pcs 1/2" Drive

10 pieces in one carton

- Contents : T30, T40, T45, T47, T50, T55, T60, T70



MB46010R

STAR BIT SOCKET SET

10pcs 1/2" Drive

8 pieces in one carton

- Contents : T20, T25, T27, T30, T40, T45, T50, T55, T60, T70



MB47010M

IMPACT HEX BALL BIT SOCKET SET

10pcs 1/2" Drive

8 pieces in one carton

- Note : Not suitable for use with high power impact wrenches.
- Contents : H6, H7, H8, H10, H12, H14, H15, H17, H18, H19



MB67006M

IMPACT HEX BALL BIT SOCKET SET

6pcs 3/4" Drive

6 pieces in one carton

- Note : Not suitable for use with high power impact wrenches.
- Contents : H14, H17, H19, H21, H24, H27



MB44008M

IMPACT HEX DRIVE SET

8pcs 1/2" Drive Metric Size SAE (Length 78mm)

12 pieces in one carton

- Contents : H6, H7, H8, H10, H12, H14, H17, H19



MB44008S

IMPACT HEX DRIVE SET

8pcs 1/2" Drive Inch Size SAE (Length 78mm)

12 pieces in one carton

- Contents : 1/4", 5/16", 3/8", 7/16", 1/2", 9/16", 5/8", 3/4"



MB66006M

IMPACT HEX DRIVE SET

6pcs 3/4" SAE 100mm Length

5 pieces in one carton

- Contents : H12, H14, H17, H19, H22, H24



MB66006S

IMPACT HEX DRIVE SET

6pcs 3/4" SAE 100mm Length

5 pieces in one carton

- Contents : 1/2", 9/16", 5/8", 3/4", 7/8", 1"



ME011N

IMPACT ADAPTER IMPACT UNIVERSAL JOINT

6 pieces in one carton

- IMPACT ADAPTER
- Contents : 1/4"Fx3/8"M, 3/8"Fx1/4"M, 3/8"Fx1/2"M, 1/2"Fx3/8"M, 1/2"Fx3/4"M, 3/4"Fx1/2"M, 3/4"Fx1"M, 1"Fx3/4"M
- IMPACT UNIVERSAL JOINT
- Contents : 1/4"Dr, 3/8"Dr, 1/2"Dr



MA4550M50

TWIST SOCKET SET

5PCS 1/2" Drive (50mm Length)

20 pieces in one carton

- Contents : 17mm, 19mm, 21mm, 22mm
Punch Bar / 12-80L



MA42011S

STD IMPACT SOCKET SET

11pcs 1/2" Drive

10 pieces in one carton

- Contents : 5/16", 3/8", 7/16", 1/2", 9/16", 5/8", 11/16", 3/4", 13/16", 7/8", 15/16"



MA42026

STUBBY METRIC IMPACT SOCKET SET

26pcs 1/2" Drive

10 pieces in one carton

- Contents :
- S : 5/16", 3/8", 7/16", 1/2", 9/16", 5/8", 11/16", 3/4", 13/16", 7/8", 15/16"
- M : 10mm, 11mm, 12mm, 13mm, 14mm, 15mm, 16mm, 17mm, 18mm, 19mm, 20mm, 21mm, 22mm, 23mm, 24mm



MA4030

DEEP IMPACT SOCKET SET

3pcs 1/2" Drive

24 pieces in one carton

- Contents : 17mm, 19mm, 21mm By identifying the different color coated, the operator can easily pick up the size needed.
- With the external sheath, the working object can be well protected from being rubbed, scratched, impacted...etc. With the 85mm extra long socket, to loosen or tighten bolt or nut in deeper hole become easier and convenient.
- Note : Impact socket for aluminum rim wheel nuts, with polymeric material insets.



MA4031M85

DEEP THIN WALL IMPACT SOCKET SET

3pcs 1/2" Drive

20 pieces in one carton

- 17mm, 19mm, 21mm



**STRENGTHEN!
STEEL
SLEEVE!**

MA42006M

IMPACT SOCKET SET

1/2" Drive Stubby Metric Size

24 pieces in one carton



M7 NO.	⊘	D1	D2	ℓ	L	⚖
	mm	mm	mm	mm	mm	g
MA401M13	13	20	25	5	28	54
MA401M17	17	26	26	8	28	70
MA401M19	19	28	28	9	28	80
MA401M21	21	30	30	9	28	90
MA401M22	22	32	30	9	28	100
MA401M24	24	34	30	9	28	110

MA42006S

IMPACT SOCKET SET

1/2" Drive Stubby Metric Size

24 pieces in one carton



M7 NO.	⊘	D1	D2	ℓ	L	⚖
	mm	mm	mm	mm	mm	g
MA401S16	1/2"	20	25	5	28	51
MA401S18	9/16"	22	25	5	28	54
MA401S20	5/8"	25	25	8	28	61
MA401S22	11/16"	26	25	8	28	90
MA401S24	3/4"	28	30	9	28	100
MA401S28	7/8"	32	30	9	28	95

MA42015M

IMPACT SOCKET SET

15pcs 1/2" Drive Stubby Metric Size

12 pieces in one carton



M7 NO.	⊘	D1	D2	T	L	⚖
	mm	mm	mm	mm	mm	g
MA401M10	10	18	25	5	28	50
MA401M11	11	18	25	5	28	50
MA401M12	12	19	25	5	28	50
MA401M13	13	20	25	5	28	52
MA401M14	14	22	25	5	28	53
MA401M15	15	23	25	5	28	55
MA401M16	16	25	25	8	28	62
MA401M17	17	26	26	8	28	67
MA401M18	18	28	28	8	28	82
MA401M19	19	28	28	9	28	75
MA401M20	20	30	30	9	28	90
MA401M21	21	30	30	9	28	86
MA401M22	22	32	30	9	28	94
MA401M23	23	34	30	9	28	102
MA401M24	24	34	30	9	28	98

MA8050

WHEEL IMPACT SOCKET SET

5pcs 1" Drive Combination Budd

4 pieces in one carton

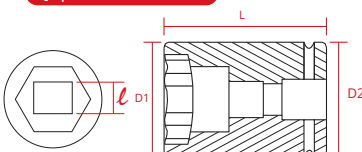

M7 NO.	⊘	D1	D2	ℓ	L	⚖
	mm	mm	mm	mm	mm	g
MA812S4826	1-1/2"	57	57	13/16"	99	1.34
MA812M3517	35	52	54	17	94	1.10
MA812M3820	38	54	56	20	96	1.18
MA812M4121	41	54	58	21	99	1.19
MA831M33L	33	52	52	---	90	1.01
MA8050	---	---	---	---	---	6.20

IMPACT SOCKET

**PROVIDE FULL RANGE
ALL SERIES HANG TAG.**



IMPACT SOCKET



MALE ADAPTER



IMPACT DEEP SOCKET



UNIVERSAL JOINT



IMPACT HEX BIT



EXTENSION BAR

IMPACT SOCKET

1/4" MA211M IMPACT STANDARD SOCKET SET

- 1/4" Drive Standard Length
- 6 Points
- Metric Size



M7 NO.	⊙	D1	D2	l	L	⚖	📦
	mm	mm	mm	mm	mm	g	
MA211M04	4	7.5	13.0	5	23	16	50
MA211M05	5	8.7	13.0	6	23	16	50
MA211M06	6	9.9	13.0	8	23	15	50
MA211M07	7	11.1	13.0	8	23	14	50
MA211M08	8	12.3	13.0	8	23	14	50
MA211M09	9	13.8	13.0	8	23	14	50
MA211M10	10	14.5	13.0	8	23	15	50
MA211M11	11	16.0	13.0	8	23	17	50
MA211M12	12	17.0	13.0	8	23	17	50
MA211M13	13	18.8	13.0	8	23	20	50
MA211M14	14	20.0	13.0	8	23	21	50

1/4" MA211S IMPACT STANDARD SOCKET

- 1/4" Drive Standard Length
- 6 Points
- Inch Size



M7 NO.	⊙	D1	D2	l	L	⚖	📦
	inch	mm	mm	mm	mm	g	
MA211S06	3/16"	8.4	13.0	6	23	15	50
MA211S07	7/32"	9.4	13.0	6	23	16	50
MA211S08	1/4"	10.3	13.0	8	23	15	50
MA211S09	9/32"	11.3	13.0	8	23	15	50
MA211S10	5/16"	12.3	13.0	8	23	14	50
MA211S11	11/32"	13.8	13.0	8	23	14	50
MA211S12	3/8"	14.5	13.0	8	23	15	50
MA211S14	7/16"	16.0	13.0	8	23	16	50
MA211S16	1/2"	18.8	13.0	8	23	19	50
MA211S18	9/16"	19.8	13.0	8	23	21	50

1/4" MA231M

IMPACT DEEP SOCKET

- 1/4" Drive Deep Length
- 6 Points
- Metric Size

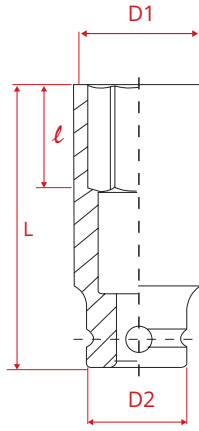

M7 NO.	⊘	D1	D2	l	L	⚖	📦
	mm	mm	mm	mm	mm	g	
MA231M04	4	7.5	13.0	7	50	28	50
MA231M05	5	8.7	13.0	9	50	29	50
MA231M06	6	9.9	13.0	11	50	31	50
MA231M07	7	11.1	13.0	11	50	31	50
MA231M08	8	12.3	13.0	13	50	31	50
MA231M09	9	13.8	13.0	13	50	37	50
MA231M10	10	14.5	13.0	13	50	37	50
MA231M11	11	16.0	13.0	13	50	41	50
MA231M12	12	17.0	13.0	13	50	43	50
MA231M13	13	18.8	13.0	13	50	58	50
MA231M14	14	20.0	13.0	13	50	60	50

1/4" MA231S

IMPACT DEEP SOCKET

- 1/4" Drive Deep Length
- 6 Points
- Inch Size

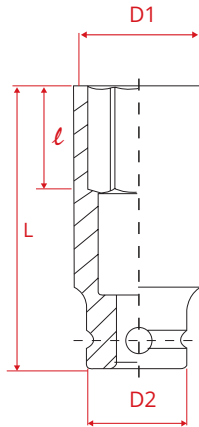

M7 NO.	⊘	D1	D2	l	L	⚖	📦
	inch	mm	mm	mm	mm	g	
MA231S06	3/16"	8.4	13.0	9	50	29	50
MA231S07	7/32"	9.4	13.0	9	50	30	50
MA231S08	1/4"	10.3	13.0	11	50	31	50
MA231S09	9/32"	11.3	13.0	11	50	32	50
MA231S10	5/16"	12.3	13.0	13	50	32	50
MA231S11	11/32"	13.8	13.0	13	50	37	50
MA231S12	3/8"	14.5	13.0	13	50	41	50
MA231S14	7/16"	16.0	13.0	13	50	41	50
MA231S16	1/2"	18.8	13.0	13	50	56	50
MA231S18	9/16"	19.8	13.0	13	50	61	50

3/8" MA311M

IMPACT STANDARD SOCKET

- 3/8" Drive Standard Length
- 6 Points
- Metric Size

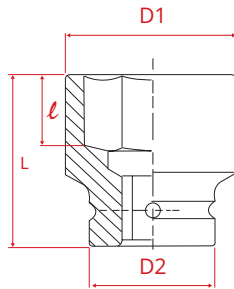

M7 NO.	⊘	D1	D2	l	L	⚖	📦
	mm	mm	mm	mm	mm	g	
MA311M06	6	10.0	19.0	9	29.5	31	50
MA311M07	7	11.4	19.0	9	29.5	31	50
MA311M08	8	12.7	19.0	9	29.5	31	50
MA311M09	9	14.0	19.0	10	29.5	33	50
MA311M10	10	15.2	19.0	10	29.5	33	50
MA311M11	11	17.0	19.0	11	29.5	34	50
MA311M12	12	18.0	19.0	11	29.5	35	50
MA311M13	13	19.0	19.0	11	29.5	36	50
MA311M14	14	20.0	19.0	11	29.5	37	50
MA311M15	15	21.9	19.0	13	29.5	42	50
MA311M16	16	23.5	22.0	13	30.0	57	50
MA311M17	17	25.0	22.0	13	30.0	59	50
MA311M18	18	26.0	22.0	13	30.0	61	50
MA311M19	19	27.0	22.0	15	30.0	63	50
MA311M20	20	28.0	22.0	15	30.0	79	50
MA311M21	21	30.0	22.0	15	30.0	79	50
MA311M22	22	32.0	22.0	15	30.0	98	50
MA311M23	23	33.0	22.0	15	30.0	98	50
MA311M24	24	34.0	22.0	15	30.0	98	50

3/8" MA311S

IMPACT STANDARD SOCKET

- 3/8" Drive Standard Length
- 6 Points
- Inch Size

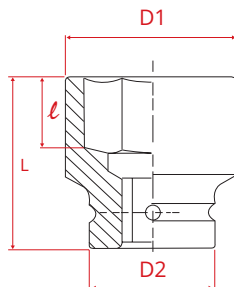

M7 NO.	⊘	D1	D2	l	L	⚖	📦
	inch	mm	mm	mm	mm	g	
MA311S10	5/16"	12.6	19.0	9.0	29.5	31	50
MA311S12	3/8"	14.6	19.0	10.0	29.5	33	50
MA311S14	7/16"	17.1	19.0	11.0	29.5	33	50
MA311S16	1/2"	19.0	19.0	11.0	29.5	37	50
MA311S18	9/16"	20.0	19.0	11.0	29.5	39	50
MA311S20	5/8"	23.5	22.0	13.0	30.0	54	50
MA311S22	11/16"	25.0	22.0	13.0	30.0	56	50
MA311S24	3/4"	27.0	22.0	15.0	30.0	63	50
MA311S26	13/16"	30.0	22.0	15.0	30.0	79	50
MA311S28	7/8"	32.0	22.0	15.0	30.0	87	50
MA311S30	15/16"	34.0	22.0	15.0	30.0	98	50
MA311S32	1"	36.0	22.0	15.0	30.0	100	50

IMPACT SOCKET

IMPACT SOCKET

3/8" MA331M

IMPACT DEEP SOCKET

- 3/8" Drive Deep Length
- 6 Points
- Metric Size

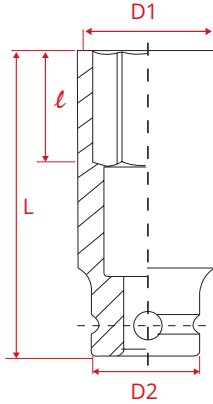

M7 NO.	⊘	D1	D2	l	L	⚖	📦
	mm	mm	mm	mm	mm	g	
MA331M06	6	10.1	19.0	14	63	73	50
MA331M07	7	11.4	19.0	14	63	73	50
MA331M08	8	12.7	19.0	14	63	73	50
MA331M09	9	14.0	19.0	14	63	75	50
MA331M10	10	15.2	19.0	20	63	76	50
MA331M11	11	17.0	19.0	20	63	81	50
MA331M12	12	18.0	19.0	22	63	78	50
MA331M13	13	19.0	19.0	24	63	86	50
MA331M14	14	20.0	19.0	26	63	93	50
MA331M15	15	22.2	19.0	27	63	102	50
MA331M16	16	23.5	22.0	26	63	115	50
MA331M17	17	25.0	22.0	26	63	127	50
MA331M18	18	26.0	22.0	26	63	137	50
MA331M19	19	27.0	22.0	26	63	143	50
MA331M20	20	28.0	22.0	26	63	143	50
MA331M21	21	30.0	22.0	26	63	194	50
MA331M22	22	32.0	22.0	26	63	206	50
MA331M23	23	33.0	22.0	26	63	206	50

3/8" MA331S

IMPACT DEEP SOCKET

- 3/8" Drive Deep Length
- 6 Points
- Inch Size

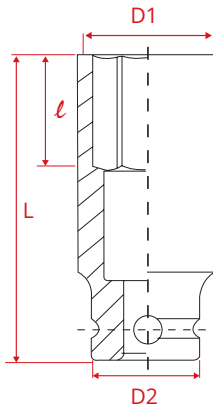

M7 NO.	⊘	D1	D2	l	L	⚖	📦
	inch	mm	mm	mm	mm	g	
MA331S08	1/4"	10.5	19.0	4.0	28.5	35	50
MA331S10	5/16"	12.6	19.0	14	63	73	50
MA331S12	3/8"	14.6	19.0	20	63	76	50
MA331S14	7/16"	17.1	19.0	20	63	81	50
MA331S16	1/2"	19.0	19.0	24	63	83	50
MA331S18	9/16"	20.0	19.0	26	63	87	50
MA331S20	5/8"	23.5	22.0	26	63	111	50
MA331S22	11/16"	25.0	22.0	26	63	125	50
MA331S24	3/4"	27.0	22.0	26	63	142	50
MA331S26	13/16"	30.0	22.0	26	63	178	50
MA331S28	7/8"	32.0	22.0	26	63	188	50
MA331S30	15/16"	34.0	22.0	26	63	232	50
MA331S32	1"	36.0	22.0	26	63	249	50

MA401M

IMPACT SOCKET

- 1/2" Drive Stubby Metric Size

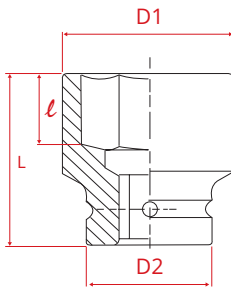

M7 NO.	⊘	D1	D2	l	L	⚖	📦
	mm	mm	mm	mm	mm	g	
MA401M09	9	18	25	5	28	48	100
MA401M10	10	18	25	5	28	50	100
MA401M11	11	18	25	5	28	50	100
MA401M12	12	19	25	5	28	50	100
MA401M13	13	20	25	5	28	52	100
MA401M14	14	22	25	5	28	53	100
MA401M15	15	23	25	5	28	55	100
MA401M16	16	25	25	8	28	62	100
MA401M17	17	26	26	8	28	67	100
MA401M18	18	28	28	8	28	82	100
MA401M19	19	28	28	9	28	80	100
MA401M20	20	30	30	9	28	90	100
MA401M21	21	30	30	9	28	86	100
MA401M22	22	32	30	9	28	94	100
MA401M23	23	34	30	9	28	102	100
MA401M24	24	34	30	9	28	98	100

MA401S

IMPACT SOCKET

- 1/2" Drive Stubby Inch Size

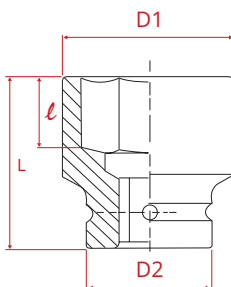

M7 NO.	⊘	D1	D2	l	L	⚖	📦
	inch	mm	mm	mm	mm	g	
MA401S10	5/16"	14.5	25	5	28	46	100
MA401S12	3/8"	16	25	5	28	47	100
MA401S14	7/16"	18	25	5	28	50	100
MA401S16	1/2"	20	25	5	28	51	100
MA401S18	9/16"	22	25	5	28	54	100
MA401S20	5/8"	25	25	8	28	61	100
MA401S26	13/16"	30	30	9	28	88	100
MA401S28	7/8"	32	30	9	28	95	100
MA401S30	15/16"	34	30	9	28	98	100

1/2" MA411M

IMPACT STANDARD SOCKET

- 1/2" Drive Standard Length
- 6 Points
- Metric Size

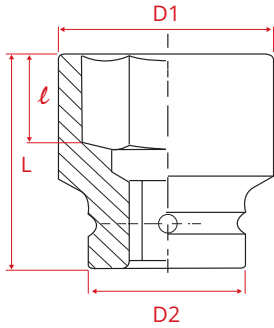

M7 NO.	⊙	D1	D2	ℓ	L	⚖	📦
	mm	mm	mm	mm	mm	g	
MA411M08	8	14.5	25.0	9	38	80	75
MA411M09	9	15.6	25.0	10	38	80	75
MA411M10	10	16.7	25.0	10	38	71	75
MA411M11	11	18.0	25.0	10	38	72	75
MA411M12	12	19.0	25.0	11	38	72	75
MA411M13	13	20.2	25.0	11	38	74	75
MA411M14	14	21.5	25.0	11	38	77	75
MA411M15	15	23.0	25.0	12	38	78	75
MA411M16	16	24.9	25.0	12	38	82	75
MA411M17	17	25.9	25.0	13	38	84	75
MA411M18	18	26.9	25.0	13	38	88	75
MA411M19	19	29.9	25.0	13	38	88	50
MA411M20	20	29.9	25.0	13	38	90	50
MA411M21	21	32.0	30.0	14.5	38	93	50
MA411M22	22	32.0	30.0	14.5	38	134	50
MA411M23	23	34.0	30.0	16	42	138	20
MA411M24	24	36.0	30.0	17	42	138	20
MA411M25	25	36.0	30.0	17	42	150	20
MA411M26	26	38.0	30.0	17	42	158	20
MA411M27	27	38.0	30.0	19	46	159	20
MA411M28	28	38.0	30.0	16	46	270	20
MA411M29	29	38.0	30.0	16	46	270	20
MA411M30	30	41.9	30.0	19	46	222	20
MA411M31	31	43.9	30.0	20.5	46	244	20
MA411M32	32	43.9	30.0	20.5	46	238	20
MA411M33	33	45.9	30.0	22	46	290	20
MA411M34	34	45.9	30.0	22	46	330	20
MA411M35	35	49.9	30.0	22	50	357	20
MA411M36	36	49.9	30.0	22	50	376	20
MA411M37	37	50.9	30.0	25	50	380	20
MA411M38	38	51.9	30.0	25	50	390	20

1/2" MA411S

IMPACT STANDARD SOCKET

- 1/2" Drive Standard Length
- 6 Points
- Inch Size

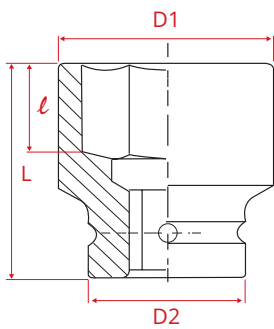

M7 NO.	⊙	D1	D2	ℓ	L	⚖	📦
	inch	mm	mm	mm	mm	g	
MA411S08	1/4"	12.5	25.0	8	38	70	40
MA411S10	5/16"	14.5	25.0	8	38	70	40
MA411S12	3/8"	16.0	25.0	8	38	70	40
MA411S14	7/16"	18.0	25.0	9	38	72	40
MA411S16	1/2"	20.0	25.0	11	38	74	40
MA411S18	9/16"	22.0	25.0	11	38	76	40
MA411S20	5/8"	24.9	25.0	12	38	81	40
MA411S22	11/16"	26.0	25.0	12	38	83	40
MA411S24	3/4"	28.0	25.0	12	38	85	40
MA411S26	13/16"	30.0	25.0	13	38	94	40
MA411S28	7/8"	32.0	30.0	13	38	134	40
MA411S30	15/16"	34.0	30.0	15	38	135	40
MA411S32	1"	36.0	30.0	15	38	144	40
MA411S34	1-1/16"	38.0	30.0	17	40	203	20
MA411S36	1-1/8"	40.0	30.0	18.5	40	260	20
MA411S38	1-3/16"	42.0	30.0	18.5	40	280	20
MA411S40	1-1/4"	44.0	30.0	18.5	40	290	20
MA411S42	1-5/16"	46.0	30.0	21	43	301	20
MA411S44	1-3/8"	48.0	30.0	21	43	338	20
MA411S46	1-7/16"	50.0	30.0	21	43	357	20
MA411S48	1-1/2"	52.0	30.0	23.5	43	376	20

IMPACT SOCKET

1/2" MA431M

IMPACT DEEP SOCKET

- 1/2" Drive Deep Length
- 6 Points
- Metric Size

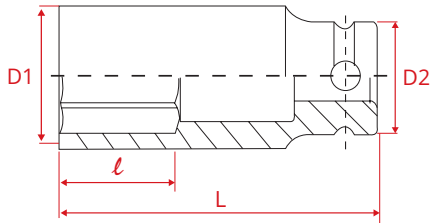

1/2" MA431S

IMPACT DEEP SOCKET

- 1/2" Drive Deep Length
- 6 Points
- Inch Size

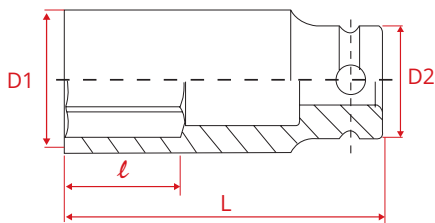

M7 NO.	⊘	D1	D2	ℓ	L	⚖	📦
	mm	mm	mm	mm	mm	g	
MA431M06	6	12.0	25.0	10	82	168	50
MA431M07	7	13.0	25.0	10	82	168	50
MA431M08	8	14.5	25.0	13	82	168	50
MA431M09	9	15.6	25.0	15	82	168	50
MA431M10	10	16.7	25.0	15	82	168	50
MA431M11	11	18.0	25.0	15	82	169	50
MA431M12	12	19.0	25.0	15	82	170	50
MA431M13	13	20.2	25.0	15	82	176	50
MA431M14	14	21.5	25.0	18	82	180	50
MA431M15	15	23.0	25.0	18	82	184	50
MA431M16	16	24.9	25.0	18	82	190	50
MA431M17	17	25.9	25.0	19	82	196	50
MA431M18	18	26.9	25.0	19	82	214	50
MA431M19	19	29.9	30.0	19	82	216	50
MA431M20	20	29.9	30.0	26	82	220	50
MA431M21	21	31.9	30.0	26	82	222	50
MA431M22	22	31.9	30.0	26	82	288	50
MA431M23	23	33.9	30.0	26	82	338	20
MA431M24	24	35.9	30.0	26	82	377	20
MA431M25	25	35.9	30.0	26	82	369	20
MA431M26	26	37.9	30.0	26	82	321	20
MA431M27	27	39.9	30.0	26	82	454	20
MA431M28	28	39.9	30.0	26	82	442	20
MA431M29	29	41.9	30.0	26	82	451	20
MA431M30	30	41.9	30.0	26	82	431	20
MA431M31	31	43.9	30.0	26	90	480	20
MA431M32	32	43.9	30.0	26	90	497	20
MA431M33	33	45.9	30.0	38	90	590	20
MA431M34	34	45.9	30.0	38	90	554	20
MA431M35	35	49.9	30.0	38	93	690	20
MA431M36	36	49.9	30.0	38	93	670	20

M7 NO.	⊘	D1	D2	ℓ	L	⚖	📦
	inch	mm	mm	mm	mm	g	
MA431S08	1/4"	12.5	25.0	10	82	160	40
MA431S10	5/16"	14.5	25.0	13	82	160	40
MA431S12	3/8"	16.0	25.0	15	82	167	40
MA431S14	7/16"	18.0	25.0	15	82	171	40
MA431S16	1/2"	20.0	25.0	15	82	176	40
MA431S18	9/16"	22.0	25.0	17	82	181	40
MA431S20	5/8"	24.9	25.0	18	82	187	40
MA431S22	11/16"	25.9	25.0	18	82	194	40
MA431S24	3/4"	27.9	25.0	18	82	217	20
MA431S26	13/16"	29.9	25.0	26	82	227	20
MA431S28	7/8"	31.9	30.0	26	82	290	20
MA431S30	15/16"	33.9	30.0	26	82	319	20
MA431S32	1"	35.9	30.0	26	82	346	20
MA431S34	1-1/16"	37.9	30.0	26	82	450	20
MA431S36	1-1/8"	39.9	30.0	26	82	450	20
MA431S38	1-3/16"	41.9	30.0	26	82	480	20
MA431S40	1-1/4"	43.9	30.0	26	82	500	20
MA431S42	1-5/16"	45.9	30.0	34	90	565	20
MA431S44	1-3/8"	47.9	30.0	34	90	595	20
MA431S46	1-7/16"	49.9	30.0	34	90	699	20
MA431S48	1-1/2"	51.8	30.0	34	90	744	20

IMPACT SOCKET

3/4" MA611S

IMPACT STANDARD SOCKET

- 3/4" Drive Standard Length
- 6 Points
- Inch Size

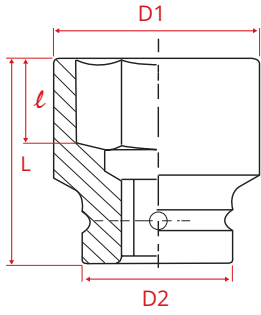

M7 NO.	⊙	D1	D2	l	L	⚖	📦
	inch						
MA611S16	1/2"	22	38	6.3	50	380	50
MA611S18	9/16"	25.5	38	6.3	50	380	50
MA611S20	5/8"	27.5	38	7.1	50	380	50
MA611S22	11/16"	29	38	8.1	50	390	50
MA611S24	3/4"	30.2	38	9	52	390	50
MA611S26	13/16"	32	38	10.6	52	400	50
MA611S28	7/8"	34	38	12.2	52	440	50
MA611S30	15/16"	36	38	12.4	52	440	50
MA611S32	1"	38	38	12.4	52	450	50
MA611S34	1-1/16"	40	40	12.4	52	510	50
MA611S36	1-1/8"	42	42	16.1	52	570	50
MA611S38	1-3/16"	44	44	16.1	52	610	35
MA611S40	1-1/4"	46	44	16.1	52	630	35
MA611S42	1-5/16"	50	44	18.8	56	660	35
MA611S44	1-3/8"	52	44	18.8	56	770	35
MA611S46	1-7/16"	54	44	18.8	56	770	35
MA611S48	1-1/2"	56	44	21.5	56	830	25
MA611S50	1-9/16"	58	44	21.5	58	860	25
MA611S52	1-5/8"	60	44	21.5	58	870	25
MA611S54	1-11/16"	63.5	44	24.6	62	1050	25
MA611S56	1-3/4"	65	44	24.9	62	1090	25
MA611S58	1-13/16"	67	44	25.1	63	1150	25
MA611S60	1-7/8"	68	44	27	68	1200	25
MA611S62	1-15/16"	70	44	27	70	1250	25
MA611S64	2"	71	44	27	72	1310	25
MA611S66	2-1/16"	74	54	29.2	72	1380	25
MA611S68	2-1/8"	77	54	30.3	72	1650	20
MA611S70	2-3/16"	77	54	30.3	74	1700	20
MA611S72	2-1/4"	80	54	32.4	74	1720	20
MA611S74	2-5/16"	82	54	32.8	75	1810	20
MA611S76	2-3/8"	84	54	33.1	80	2050	20
MA611S78	2-7/16"	85	54	34.4	80	2080	10
MA611S80	2-1/2"	86	54	34.4	80	2250	10
MA611S82	2-9/16"	88	54	35.1	80	2300	5
MA611S84	2-5/8"	88	54	35.1	80	2300	5
MA611S86	2-11/16"	88	54	36.4	80	2300	5
MA611S88	2-3/4"	96	54	37.8	85	2450	5
MA611S90	2-13/16"	96	60	38.1	88	2550	5
MA611S92	2-7/8"	98	60	39.4	90	2600	5
MA611S94	2-15/16"	100	60	46	92	2700	5
MA611S96	3"	100	60	46	92	2800	5

3/4" MA611M

IMPACT STANDARD SOCKET

- 3/4" Drive Standard Length
- 6 Points
- Metric Size

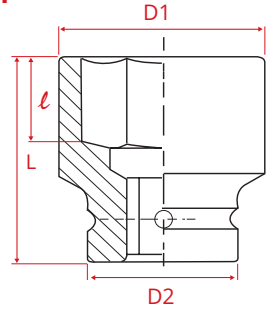

M7 NO.	⊙	D1	D2	l	L	⚖	📦
	mm						
MA611M13	13	22	38	7	50	210	50
MA611M14	14	25.5	38	7	50	210	50
MA611M15	15	26	38	7	50	220	50
MA611M16	16	27.5	38	7	50	220	50
MA611M17	17	28.5	38	9.6	50	230	50
MA611M18	18	29.5	38	10.2	52	230	50
MA611M19	19	30	38	11.1	52	230	50
MA611M20	20	31	38	11.5	52	240	50
MA611M21	21	32	38	11.7	52	240	50
MA611M22	22	34	38	12.5	52	250	50
MA611M23	23	35	38	12.7	52	250	50
MA611M24	24	36	38	14	52	250	50
MA611M25	25	38	38	14	52	270	50
MA611M26	26	38	38	14.6	52	270	50
MA611M27	27	40	40	15.8	52	280	50
MA611M28	28	42	42	16.3	52	320	50
MA611M29	29	42	42	16.7	52	320	50
MA611M30	30	46	44	16.7	52	370	50
MA611M31	31	46	44	16.7	52	370	50
MA611M32	32	48	44	18.3	52	380	30
MA611M33	33	50	44	19.1	56	410	30
MA611M34	34	51	44	20	56	410	30
MA611M35	35	52	44	20.1	56	470	25
MA611M36	36	53.5	44	21.5	56	470	25
MA611M37	37	54	44	21.5	56	470	25
MA611M38	38	56	44	22.3	56	470	25
MA611M39	39	56	44	22.3	58	480	25
MA611M40	40	58	44	22.8	58	540	25
MA611M41	41	60	44	23	58	590	25
MA611M42	42	61	44	23	58	660	25
MA611M43	43	63	44	23	62	700	25
MA611M44	44	65	44	23	62	720	25
MA611M45	45	66	44	23	63	740	25
MA611M46	46	67	44	23	63	770	25
MA611M47	47	68	44	27	68	820	20
MA611M48	48	69	44	27	68	830	20
MA611M49	49	70	44	29	70	830	20
MA611M50	50	71	54	29.8	72	970	20
MA611M51	51	71	54	29.8	72	1150	20
MA611M52	52	74	54	29.8	72	1250	20
MA611M54	54	77	54	29.8	72	1250	20
MA611M55	55	77	54	29.8	74	1250	20
MA611M56	56	77	54	31	74	1450	20
MA611M57	57	80	54	31	74	1550	20
MA611M58	58	82	54	31	74	1580	20
MA611M59	59	82	54	33	75	1600	20
MA611M60	60	84	54	33	80	1620	20
MA611M62	62	85	54	33	80	1650	10
MA611M63	63	86	54	33	80	1720	10
MA611M65	65	88	54	33	80	1790	10
MA611M67	67	90	54	35	80	1850	10
MA611M70	70	96	54	35	85	1920	10
MA611M73	73	98	54	42	88	1920	5
MA611M75	75	100	60	44	90	2340	5

IMPACT SOCKET

3/4" MA631S IMPACT DEEP SOCKET

- 3/4" Drive Deep Length
- 6 Points
- Inch Size

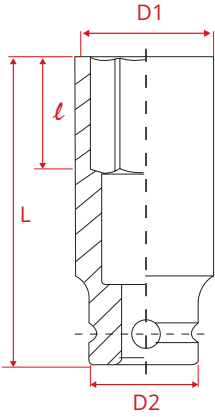

M7 NO.	⊙	D1	D2	ℓ	L	⚖	📦
	inch	mm	mm	mm	mm	g	
MA631S16	1/2"	22	38	12	90	380	25
MA631S18	9/16"	25.5	38	12	90	380	25
MA631S20	5/8"	27.5	38	12	90	380	25
MA631S22	11/16"	29	38	12	90	380	25
MA631S24	3/4"	30	38	12	90	390	25
MA631S26	13/16"	32	38	12	90	390	25
MA631S28	7/8"	34	38	19	90	400	25
MA631S30	15/16"	36	38	19	90	440	25
MA631S32	1"	38	38	19	90	440	25
MA631S34	1-1/16"	40	40	19	90	450	25
MA631S36	1-1/8"	42	42	19	90	510	25
MA631S38	1-3/16"	44	44	19	90	570	20
MA631S40	1-1/4"	46	44	19	90	610	20
MA631S42	1-5/16"	50	44	19	90	630	20
MA631S44	1-3/8"	52	44	19	90	660	20
MA631S46	1-7/16"	54	44	19	90	770	20
MA631S48	1-1/2"	56	44	22	92	770	20
MA631S50	1-9/16"	58	44	40	92	830	20
MA631S52	1-5/8"	60	44	40	92	860	20
MA631S54	1-11/16"	63.5	44	40	92	870	10
MA631S56	1-3/4"	65	44	40	92	1050	10
MA631S58	1-13/16"	67	44	40	92	1090	10
MA631S60	1-7/8"	68	44	40	92	1150	10
MA631S62	1-15/16"	70	44	40	92	1200	10
MA631S64	2"	71	54	40	95	1250	10
MA631S66	2-1/16"	74	54	40	95	1310	10
MA631S68	2-1/8"	77	54	40	100	1380	10
MA631S70	2-3/16"	77	54	40	100	1650	10
MA631S72	2-1/4"	80	54	40	100	1700	10
MA631S74	2-5/16"	82	54	40	105	1720	10
MA631S76	2-3/8"	84	54	40	105	1810	6
MA631S78	2-7/16"	85	54	40	105	2050	6
MA631S80	2-1/2"	86	54	40	105	2080	6
MA631S82	2-9/16"	88	54	40	105	2250	1
MA631S84	2-5/8"	90	54	40	105	2300	1
MA631S86	2-11/16"	92	54	40	105	2350	1
MA631S88	2-3/4"	96	54	40	105	2400	1
MA631S90	2-13/16"	98	54	40	105	2450	1
MA631S92	2-7/8"	100	54	40	105	2650	1
MA631S94	2-15/16"	102	54	40	105	2850	1
MA631S96	3"	104	54	40	105	3050	1

3/4" MA631M IMPACT DEEP SOCKET

- 3/4" Drive Deep Length
- 6 Points
- Metric Size

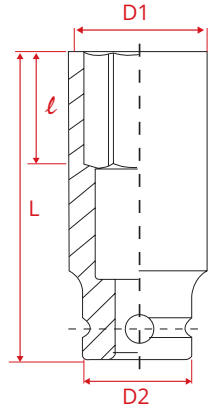

M7 NO.	⊙	D1	D2	ℓ	L	⚖	📦
	mm	mm	mm	mm	mm	g	
MA631M13	13	22	38	12	90	380	25
MA631M14	14	25.5	38	12	90	380	25
MA631M15	15	26	38	12	90	380	25
MA631M16	16	27.5	38	12	90	380	25
MA631M17	17	28.5	38	12	90	390	25
MA631M18	18	29.5	38	12	90	390	25
MA631M19	19	30	38	12	90	390	25
MA631M20	20	31	38	19	90	390	25
MA631M21	21	32	38	19	90	400	25
MA631M22	22	34	38	19	90	430	25
MA631M23	23	35	38	19	90	430	25
MA631M24	24	36	38	19	90	440	25
MA631M25	25	38	38	19	90	460	25
MA631M26	26	40	40	19	90	460	25
MA631M27	27	40	40	19	90	500	25
MA631M28	28	42	42	19	90	550	25
MA631M29	29	42	42	19	90	560	25
MA631M30	30	46	44	19	90	620	25
MA631M31	31	47	44	19	90	620	25
MA631M32	32	48	44	19	90	630	25
MA631M33	33	50	44	19	90	670	25
MA631M34	34	51	44	19	90	670	25
MA631M35	35	52	44	19	90	770	25
MA631M36	36	54	44	19	90	790	20
MA631M37	37	54	44	19	90	800	20
MA631M38	38	56	44	19	92	830	20
MA631M39	39	56	44	40	92	850	20
MA631M40	40	58	44	40	92	880	20
MA631M41	41	60	44	40	92	880	20
MA631M42	42	61	44	40	92	1050	20
MA631M43	43	63	44	40	92	1050	10
MA631M44	44	64	44	40	92	1060	10
MA631M45	45	66	44	40	92	1100	10
MA631M46	46	67	44	40	92	1150	10
MA631M47	47	68	44	40	92	1160	10
MA631M48	48	69	44	40	92	1200	10
MA631M49	49	70	44	40	92	1240	10
MA631M50	50	71	54	40	95	1320	10
MA631M51	51	72	54	40	95	1420	10
MA631M52	52	54	74	40	95	1530	10
MA631M54	54	76	54	40	100	1650	10
MA631M55	55	77	54	40	100	1670	10
MA631M56	56	78	54	40	100	1720	6
MA631M57	57	80	54	40	100	1820	6
MA631M58	58	82	54	40	105	1920	6
MA631M59	59	82	54	40	105	1920	6
MA631M60	60	84	54	40	105	2020	6
MA631M62	62	85	54	40	105	2080	6
MA631M65	65	88	54	40	105	2300	6
MA631M67	67	92	54	40	105	2350	6
MA631M70	70	96	54	40	105	2450	6
MA631M73	73	98	54	56	105	2280	5
MA631M75	75	100	60	60	110	2780	5

1" MA811S

IMPACT STANDARD SOCKET

- 1" Drive Standard Length
- 6 Points
- Inch Size



M7 NO.	Ø	D1	D2	l	L	⚖	📦
	inch	mm	mm	mm	mm	g	
MA811S20	5/8"	32	51	8	58	483	30
MA811S22	11/16"	34	51	8.1	58	480	24
MA811S24	3/4"	36	51	9.5	58	500	24
MA811S26	13/16"	38	51	11	58	510	24
MA811S28	7/8"	39	51	12.5	58	510	24
MA811S30	15/16"	40	51	12.5	58	510	24
MA811S32	1"	42	51	12.5	58	520	24
MA811S34	1-1/16"	44	51	12.5	58	520	24
MA811S36	1-1/8"	46	51	12.5	58	530	24
MA811S38	1-3/16"	48	51	16.5	60	550	24
MA811S40	1-1/4"	51	51	16.5	60	610	24
MA811S42	1-5/16"	52	52	19	62	620	24
MA811S44	1-3/8"	54	54	19	62	630	24
MA811S46	1-7/16"	56	54	19	62	640	24
MA811S48	1-1/2"	58	54	22	62	670	24
MA811S50	1-9/16"	60	54	22	62	870	24
MA811S52	1-5/8"	61.5	54	22	62	920	24
MA811S54	1-11/16"	65	54	25	64	920	20
MA811S56	1-3/4"	66	58	25	64	1000	20
MA811S58	1-13/16"	68	58	25.6	64	1000	20
MA811S60	1-7/8"	70	58	27	66	1080	10
MA811S62	1-15/16"	72	58	27	68	1080	10
MA811S64	2"	74	58	27	70	1100	10
MA811S66	2-1/16"	75	58	30	70	1200	10
MA811S68	2-1/8"	78	58	30	70	1250	10
MA811S70	2-3/16"	80	62	30	72	1450	10
MA811S72	2-1/4"	84	62	32.5	75	1520	10
MA811S74	2-5/16"	86	62	32.5	75	1520	10
MA811S76	2-3/8"	87	62	33.5	78	1720	10
MA811S78	2-7/16"	89	62	34	78	1890	10
MA811S80	2-1/2"	91	62	34	80	1900	10
MA811S82	2-9/16"	93	62	35	80	1900	10
MA811S84	2-5/8"	95	62	37.5	82	2000	10
MA811S86	2-11/16"	97	62	37.5	82	2200	10
MA811S88	2-3/4"	98	62	38	85	2250	5
MA811S90	2-13/16"	100	62	40	87	2380	5
MA811S92	2-7/8"	102	62	40	87	2400	5
MA811S94	2-15/16"	104	86	41	95	3190	5
MA811S96	3"	106	86	43	98	3450	5
MA811S98	3-1/16"	107	86	43.5	100	3550	5
MA811S100	3-1/8"	109	86	43.5	100	3620	5
MA811S104	3-1/4"	113	86	43.5	100	3800	5
MA811S108	3-3/8"	115	86	47.5	100	4050	5
MA811S112	3-1/2"	125	86	49	105	5170	2
MA811S116	3-5/8"	127	86	51	105	5200	2
MA811S120	3-3/4"	130	86	51	105	5250	2
MA811S124	3-7/8"	136	95	55	105	5990	2
MA811S126	3-15/16"	137	95	55	105	6000	2
MA811S128	4"	140	95	56	105	6000	2
MA811S132	4-1/8"	143	95	57.5	105	6500	2
MA811S136	4-1/4"	147	95	58.5	105	7200	2
MA811S144	4-1/2"	152	95	61	105	10000	2

1" MA811M

IMPACT STANDARD SOCKET

- 1" Drive Standard Length
- 6 Points
- Metric Size



M7 NO.	Ø	D1	D2	l	L	⚖	📦
	mm	mm	mm	mm	mm	g	
MA811M17	17	34	51	11.5	58	490	25
MA811M18	18	35	51	11.5	58	500	25
MA811M19	19	36	51	11.5	58	500	25
MA811M20	20	37	51	11.5	58	500	25
MA811M21	21	38	51	11.5	58	500	25
MA811M22	22	39	51	12.5	58	510	25
MA811M23	23	40	51	13	58	510	25
MA811M24	24	40.5	51	14	58	510	25
MA811M25	25	41	51	14.5	58	510	25
MA811M26	26	42.5	51	15	58	520	25
MA811M27	27	44	51	16	58	520	25
MA811M28	28	45	51	16	58	530	25
MA811M29	29	46	51	16.5	60	530	25
MA811M30	30	48	51	17	60	530	25
MA811M31	31	49	49	17	60	545	20
MA811M32	32	51	51	18.5	62	590	25
MA811M33	33	52	52	19.5	62	620	25
MA811M34	34	54	54	19.5	62	640	20
MA811M35	35	54	54	20.5	62	650	20
MA811M36	36	56	54	21.5	62	670	20
MA811M37	37	57	54	22	62	670	20
MA811M38	38	58	54	22.5	62	680	20
MA811M39	39	58.7	54	23	62	770	20
MA811M40	40	60	54	23	62	870	20
MA811M41	41	61.5	54	23	62	920	15
MA811M42	42	63	54	23	64	980	15
MA811M43	43	65	54	23	64	1000	15
MA811M44	44	65	54	23	64	1000	15
MA811M45	45	66	54	23	64	1000	15
MA811M46	46	68	54	23	64	1000	15
MA811M47	47	69	54	24	66	1000	10
MA811M48	48	70	54	27	66	1050	10
MA811M49	49	72	58	27	68	1050	10
MA811M50	50	73	54	26	70	1070	10
MA811M51	51	74	58	27	70	1070	10
MA811M52	52	75	58	30	70	1200	10
MA811M53	53	75	54	27	70	1200	10
MA811M54	54	78	58	31	70	1200	10
MA811M55	55	79	54	28	72	1440	10
MA811M56	56	80	62	31	72	1350	10
MA811M57	57	84	62	32.5	75	1350	10
MA811M58	58	85	54	30	75	1620	10
MA811M59	59	86	62	32.5	75	1620	10
MA811M60	60	87	54	31	78	1730	10
MA811M61	61	87	54	36	78	1730	10
MA811M62	62	89	62	35.5	78	1900	10
MA811M63	63	91	54	36	80	1730	10
MA811M65	65	93	54	35	80	1900	7
MA811M70	70	98	54	35	85	2190	7
MA811M73	73	102	62	40	87	2800	7
MA811M75	75	104	86	40	95	3200	5
MA811M76	76	106	86	43	98	3480	5
MA811M80	80	109	86	47	100	3650	5
MA811M85	85	115	86	47	100	4100	5
MA811M90	90	125	86	47	105	5200	5
MA811M95	95	130	86	50	105	5250	2
MA811M100	100	137	95	55	105	6050	2
MA811M105	105	143	95	55	105	6550	2
MA811M110	110	147	95	55	105	7250	2
MA811M115	115	152	95	55	105	10000	2
MA811M120	120	160	95	60	110	14000	2
MA811M125	125	165	95	63	115	19000	2

IMPACT SOCKET

IMPACT SOCKET

1" MA831S IMPACT DEEP SOCKET

- 1" Drive Deep Length
- 6 Points
- Inch Size

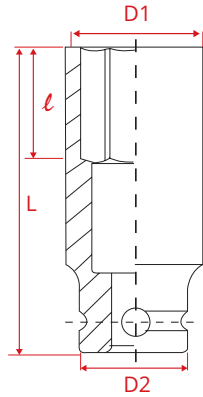

M7 NO.	Ø	D1	D2	ℓ	L	⚖	📦
	inch	mm	mm	mm	mm	g	
MA831S22	11/16"	34	51	16	90	620	20
MA831S24	3/4"	36	51	16	90	700	20
MA831S26	13/16"	38	51	16	90	700	20
MA831S28	7/8"	39	51	16	90	710	20
MA831S30	15/16"	40	51	16	90	720	20
MA831S32	1"	42	51	19	90	760	20
MA831S34	1-1/16"	44	51	19	90	800	20
MA831S36	1-1/8"	46	51	19	90	800	20
MA831S38	1-3/16"	48	51	19	90	820	20
MA831S40	1-1/4"	51	51	19	90	910	20
MA831S42	1-5/16"	52	52	23	90	910	20
MA831S44	1-3/8"	54	54	23	90	910	20
MA831S46	1-7/16"	56	54	23	90	950	20
MA831S48	1-1/2"	58	54	23	92	1000	20
MA831S50	1-9/16"	60	54	40	92	1200	5
MA831S52	1-5/8"	61.5	54	40	92	1200	5
MA831S54	1-11/16"	65	54	40	92	1200	5
MA831S56	1-3/4"	66	58	40	92	1350	5
MA831S58	1-13/16"	68	58	40	92	1350	5
MA831S60	1-7/8"	70	58	40	92	1500	5
MA831S62	1-15/16"	72	58	40	92	1560	5
MA831S64	2"	74	58	40	95	1560	5
MA831S66	2-1/16"	75	58	52	95	1600	5
MA831S68	2-1/8"	78	58	52	100	1750	5
MA831S70	2-3/16"	80	62	52	100	2000	5
MA831S72	2-1/4"	84	62	52	100	2200	5
MA831S74	2-5/16"	86	62	52	105	2260	5
MA831S76	2-3/8"	87	62	52	105	2350	5
MA831S78	2-7/16"	89	62	60	110	2500	5
MA831S80	2-1/2"	91	62	60	110	2580	5
MA831S82	2-9/16"	93	62	60	120	3000	5
MA831S84	2-5/8"	95	62	60	120	3220	5
MA831S86	2-11/16"	97	62	60	124	3250	5
MA831S88	2-3/4"	98	62	60	124	3280	5
MA831S90	2-13/16"	100	62	60	128	3700	5
MA831S92	2-7/8"	102	62	60	128	4150	5
MA831S94	2-15/16"	104	86	60	135	4550	5
MA831S96	3"	106	86	60	135	4550	4
MA831S98	3-1/16"	107	86	60	135	4850	4
MA831S100	3-1/8"	109	86	75	135	4850	4
MA831S104	3-1/4"	113	86	75	135	5150	4
MA831S108	3-3/8"	115	86	75	140	5250	2
MA831S112	3-1/2"	125	86	75	140	5750	2
MA831S116	3-5/8"	127	86	75	140	6050	2
MA831S120	3-3/4"	130	86	75	140	6320	2
MA831S124	3-7/8"	136	95	75	140	7400	2
MA831S126	3-15/16"	137	95	75	140	7500	2
MA831S128	4"	140	95	75	155	7500	2
MA831S132	4-1/8"	143	95	75	155	9800	2
MA831S136	4-1/4"	147	95	75	155	10000	2
MA831S144	4-1/2"	152	95	75	155	10000	2

1" MA831M IMPACT DEEP SOCKET

- 1" Drive Deep Length
- 6 Points
- Metric Size

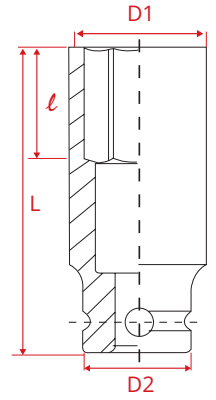

M7 NO.	Ø	D1	D2	ℓ	L	⚖	📦
	mm	mm	mm	mm	mm	g	
MA831M17	17	34	51	16	90	620	20
MA831M18	18	35	51	16	90	630	20
MA831M19	19	36	51	16	90	700	20
MA831M20	20	37	51	16	90	700	20
MA831M21	21	38	51	16	90	710	20
MA831M22	22	39	51	16	90	710	20
MA831M23	23	40	51	16	90	710	20
MA831M24	24	40.5	51	16	90	720	20
MA831M25	25	41	51	19	90	720	20
MA831M26	26	42.5	51	19	90	750	20
MA831M27	27	44	51	19	90	800	20
MA831M28	28	45	51	19	90	800	20
MA831M29	29	46	51	19	90	800	20
MA831M30	30	48	51	19	90	800	20
MA831M32	32	51	51	19	90	910	20
MA831M33	33	52	52	30	90	910	20
MA831M34	34	54	54	30	90	950	10
MA831M35	35	54	54	30	90	950	10
MA831M36	36	56	54	30	90	950	10
MA831M37	37	57	54	30	90	960	10
MA831M38	38	58	54	30	92	990	10
MA831M39	39	58.7	54	40	92	1060	10
MA831M40	40	60	54	40	92	1200	10
MA831M41	41	61.5	54	40	92	1200	10
MA831M42	42	63	54	40	92	1200	10
MA831M43	43	65	54	40	92	1200	10
MA831M44	44	65	54	40	92	1380	10
MA831M45	45	66	54	40	92	1390	10
MA831M46	46	68	54	40	92	1400	10
MA831M47	47	69	54	40	92	1410	10
MA831M48	48	70	54	40	92	1450	10
MA831M49	49	72	58	40	92	1430	10
MA831M50	50	73	54	40	95	1570	10
MA831M51	51	74	58	40	95	1570	10
MA831M52	52	75	58	52	95	1600	10
MA831M54	54	78	58	52	100	1750	10
MA831M55	55	79	54	52	100	1950	10
MA831M56	56	80	62	52	100	2150	10
MA831M57	57	84	62	52	100	2200	10
MA831M58	58	85	54	52	100	2100	10
MA831M59	59	86	62	52	105	2350	10
MA831M60	60	87	54	52	105	2350	10
MA831M62	62	89	62	60	110	2450	10
MA831M63	63	91	54	60	110	2550	10
MA831M65	65	93	54	60	120	2950	10
MA831M70	70	98	54	60	124	3300	5
MA831M73	73	102	62	60	128	4150	5
MA831M75	75	104	86	60	135	4650	5
MA831M76	76	106	86	60	135	4950	5
MA831M78	78	107	86	60	135	5450	5
MA831M80	80	109	86	75	135	6000	5
MA831M85	85	115	86	75	140	7500	5
MA831M90	90	125	86	75	140	9000	5
MA831M95	95	130	86	75	140	10500	2
MA831M100	100	137	95	75	140	12000	2
MA831M105	105	143	95	75	155	13500	2
MA831M110	110	147	95	75	155	15000	2
MA831M115	115	152	95	75	155	16500	2

IMPACT SOCKET

1-1/2" MA911S

IMPACT STANDARD SOCKET

- 1-1/2" Drive Standard Length
- 6 Points
- Inch Size

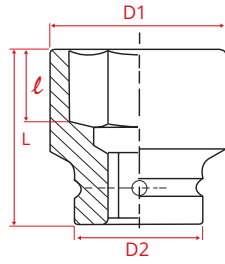

M7 NO.	⊙	D1	D2	l	L	⚖	📦
	inch	mm	mm	mm	mm	g	
MA911S38	1-3/16"	56	86	16.5	78	2200	1
MA911S40	1-1/4"	58	86	16.5	78	2200	1
MA911S42	1-5/16"	60	86	19	78	2200	1
MA911S44	1-3/8"	62	86	19.5	78	2200	1
MA911S46	1-7/16"	64	86	22.5	78	2000	1
MA911S48	1-1/2"	66	86	24	78	2200	1
MA911S50	1-9/16"	68	86	25.5	78	2200	1
MA911S52	1-5/8"	70	86	27	80	2200	1
MA911S54	1-11/16"	71	86	27	80	2200	1
MA911S56	1-3/4"	75	86	28.5	84	2300	1
MA911S58	1-13/16"	76	86	29	84	2300	1
MA911S60	1-7/8"	78	86	30	84	2300	1
MA911S62	1-15/16"	80	86	31	87	2400	1
MA911S64	2"	82	86	32	87	2400	1
MA911S66	2-1/16"	83	86	33	87	2400	1
MA911S68	2-1/8"	86	86	34.5	90	2500	1
MA911S70	2-3/16"	86	86	35	90	2500	1
MA911S72	2-1/4"	86	86	36	92	2800	1
MA911S74	2-5/16"	92	86	37	92	3100	1
MA911S76	2-3/8"	93	86	38.5	92	3100	1
MA911S78	2-7/16"	96	86	39.5	95	3400	1
MA911S80	2-1/2"	97	86	40.5	95	3400	1
MA911S82	2-9/16"	97	86	41	95	3400	1
MA911S84	2-5/8"	103	86	42.5	100	3600	1
MA911S86	2-11/16"	104	86	43	100	3800	1
MA911S88	2-3/4"	105	86	44.5	100	3800	1
MA911S90	2-13/16"	108	86	45.3	103	4000	1
MA911S92	2-7/8"	108	86	46.5	103	4100	1
MA911S94	2-15/16"	110	86	47	103	4200	1
MA911S96	3"	110	86	48	103	4300	1
MA911S98	3-1/16"	115	86	49.5	110	4400	1
MA911S100	3-1/8"	116	86	51	110	4500	1
MA911S102	3-3/16"	125	86	51	110	4800	1
MA911S104	3-1/4"	125	86	52	110	5500	1
MA911S106	3-5/16"	125	86	53.5	118	5500	1
MA911S108	3-3/8"	125	86	54	118	5500	1
MA911S110	3-7/16"	128	86	55	118	5700	1
MA911S112	3-1/2"	130	86	57.5	118	5800	1
MA911S114	3-9/16"	132	86	57.5	118	6000	1
MA911S116	3-5/8"	134	86	58	118	6200	1
MA911S118	3-11/16"	136	86	59.5	118	6400	1
MA911S120	3-3/4"	137	95	60.5	118	6600	1
MA911S122	3-13/16"	140	95	61.5	125	8600	1
MA911S124	3-7/8"	142	95	63.5	125	8900	1
MA911S126	3-15/16"	144	95	63.5	125	9300	1
MA911S128	4"	145	95	63.5	125	9450	1
MA911S130	4-1/16"	146	95	66	125	9450	1
MA911S132	4-1/8"	150	95	66	125	9500	1
MA911S134	4-3/16"	151	95	67	125	9500	1
MA911S136	4-1/4"	153	95	70	125	10300	1
MA911S138	4-5/16"	156	95	70	125	10700	1
MA911S140	4-3/8"	160	95	70	125	11500	1
MA911S142	4-7/16"	162	95	71.5	125	11800	1
MA911S144	4-1/2"	163	95	72	135	12000	1
MA911S148	4-5/8"	165	95	76.5	135	12600	1
MA911S152	4-3/4"	168	95	76.5	135	13500	1
MA911S160	5"	179	127	77	140	14500	1

1-1/2" MA911M

IMPACT STANDARD SOCKET

- 1-1/2" Drive Standard Length
- 6 Points
- Metric Size

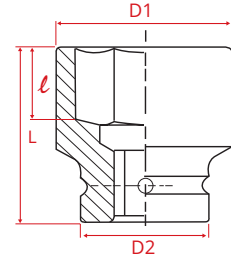

M7 NO.	⊙	D1	D2	l	L	⚖	📦
	mm	mm	mm	mm	mm	g	
MA911M30	30	56	86	17	78	2200	1
MA911M32	32	58	86	19	78	2200	1
MA911M34	34	61	86	20	78	2200	1
MA911M35	35	61	86	20	78	2200	1
MA911M36	36	64	86	22	78	2200	1
MA911M38	38	66	86	23	78	2200	1
MA911M40	40	68	86	23	78	2200	1
MA911M41	41	70	86	25	80	2200	1
MA911M42	42	70	86	25	80	2200	1
MA911M46	46	76	86	29	84	2200	1
MA911M50	50	81	86	30	87	2400	1
MA911M51	51	81	86	30	87	2400	1
MA911M52	52	87	86	30	88	2400	1
MA911M53	53	87	86	30	88	2400	1
MA911M54	54	87	86	30	88	2400	1
MA911M55	55	87	86	34	90	2500	1
MA911M57	57	87	86	34	90	2500	1
MA911M58	58	87	86	34	90	2500	1
MA911M60	60	93	86	35	92	3100	1
MA911M62	62	93	86	35	92	3100	1
MA911M63	63	93	86	35	92	3100	1
MA911M65	65	97	86	35	95	3400	1
MA911M66	66	97	86	35	95	3400	1
MA911M67	67	97	86	35	95	3400	1
MA911M68	68	104	86	35	100	3800	1
MA911M70	70	105	86	35	100	3800	1
MA911M72	72	105	86	35	100	3800	1
MA911M73	73	108	86	35	103	4100	1
MA911M75	75	110	86	35	103	4200	1
MA911M76	76	110	86	35	103	4300	1
MA911M78	78	115	86	38	110	4400	1
MA911M80	80	116	86	38	110	4650	1
MA911M85	85	125	86	41	118	5500	1
MA911M90	90	130	86	44	118	5800	1
MA911M95	95	137	95	46	118	6600	1
MA911M100	100	144	95	48	125	9300	1
MA911M105	105	150	95	51	125	9500	1
MA911M110	110	156	95	54	125	10500	1
MA911M115	115	160	95	56	135	12100	1
MA911M120	120	168	95	58	135	13200	1
MA911M125	125	175	95	61	135	14000	1
MA911M130	130	180	127	64	145	18000	1
MA911M135	135	186	127	68	150	19000	1
MA911M140	140	192	127	70	150	20000	1
MA911M145	145	198	127	74	150	21000	1
MA911M150	150	203	127	78	150	22000	1
MA911M155	155	209	127	78	150	24500	1
MA911M160	160	222	127	82	175	29800	1
MA911M165	165	228	127	90	175	32000	1
MA911M175	175	235	127	94	175	34500	1

IMPACT SOCKET

IMPACT SOCKET

1-1/2" MA931S

IMPACT DEEP SOCKET

- 1-1/2" Drive Deep Length
- 6 Points
- Inch Size

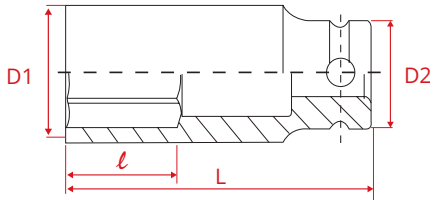

1-1/2" MA931M

IMPACT DEEP SOCKET

- 1-1/2" Drive Deep Length
- 6 Points
- Metric Size

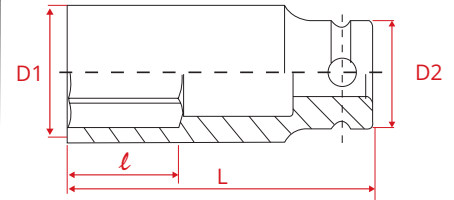

IMPACT SOCKET

M7 NO.	Ø	D1	D2	l	L	⚖	📦
	inch	mm	mm	mm	mm	g	
MA931S48	1-1/2"	68	86	27	115	3200	1
MA931S52	1-5/8"	70	86	27	115	3200	1
MA931S54	1-11/16"	73	86	27	115	3200	1
MA931S56	1-3/4"	75	86	28.5	115	3200	1
MA931S58	1-13/16"	76	86	29	115	3200	1
MA931S60	1-7/8"	78	86	30	115	3200	1
MA931S62	1-15/16"	80	86	31	115	3600	1
MA931S64	2"	82	86	32	135	3800	1
MA931S66	2-1/16"	83	86	33	140	3900	1
MA931S68	2-1/8"	86	86	35	140	3900	1
MA931S70	2-3/16"	86	86	35	140	3900	1
MA931S72	2-1/4"	86	86	36	150	4700	1
MA931S74	2-5/16"	92	86	37	150	4700	1
MA931S76	2-3/8"	93	86	38.5	150	5200	1
MA931S78	2-7/16"	96	86	39.5	150	5200	1
MA931S80	2-1/2"	97	86	40.5	150	5200	1
MA931S82	2-9/16"	97	86	41	150	5700	1
MA931S84	2-5/8"	103	86	42.5	150	5700	1
MA931S86	2-11/16"	104	86	43	150	6300	1
MA931S88	2-3/4"	105	86	45	160	6700	1
MA931S90	2-13/16"	108	86	45.5	160	6700	1
MA931S92	2-7/8"	108	86	46.5	160	7320	1
MA931S94	2-15/16"	110	86	47	170	7800	1
MA931S96	3"	110	86	48	170	8500	1
MA931S98	3-1/16"	115	86	49.5	170	8500	1
MA931S100	3-1/8"	116	86	51	170	8500	1
MA931S102	3-3/16"	125	86	51	170	9900	1
MA931S104	3-1/4"	125	86	52	170	9900	1
MA931S106	3-5/16"	125	86	53.5	170	9900	1
MA931S108	3-3/8"	125	86	54	170	9900	1
MA931S110	3-7/16"	128	86	55	170	10300	1
MA931S112	3-1/2"	130	86	57.5	170	10700	1
MA931S114	3-9/16"	132	86	57.5	170	10700	1
MA931S116	3-5/8"	134	86	58	170	11000	1
MA931S118	3-11/16"	136	86	59.5	170	11200	1
MA931S120	3-3/4"	137	95	60.5	180	12200	1
MA931S122	3-13/16"	140	95	61.5	180	12500	1
MA931S124	3-7/8"	142	95	63.5	180	13100	1
MA931S126	3-15/16"	144	95	63.5	190	14100	1
MA931S128	4"	145	95	63.5	190	14900	1
MA931S130	4-1/16"	146	95	66	190	15200	1
MA931S132	4-1/8"	150	95	66	190	15800	1
MA931S134	4-3/16"	151	95	67	190	16500	1
MA931S136	4-1/4"	153	95	70	190	16800	1
MA931S138	4-5/16"	156	95	70	200	17000	1
MA931S140	4-3/8"	160	95	70	200	18200	1
MA931S142	4-7/16"	162	95	71.5	200	19100	1
MA931S144	4-1/2"	163	95	72	210	20100	1
MA931S148	4-5/8"	165	95	76.5	210	20900	1
MA931S152	4-3/4"	168	95	76.5	210	21500	1

M7 NO.	Ø	D1	D2	l	L	⚖	📦
	mm	mm	mm	mm	mm	g	
MA931M38	38	66	86	23.6	110	2760	5
MA931M41	41	70	86	25	115	3200	1
MA931M42	42	73	86	27	115	3200	1
MA931M46	46	76	86	29	115	3200	1
MA931M49	49	80	86	30	115	3200	1
MA931M50	50	81	86	30	135	3200	1
MA931M54	54	86	86	34	140	3900	1
MA931M55	55	87	86	34	140	3900	1
MA931M57	57	86	86	35	150	4300	1
MA931M58	58	93	86	35	150	4600	1
MA931M60	60	96	86	35	150	5150	1
MA931M62	62	97	86	35	150	5150	1
MA931M65	65	105	86	35	150	5700	1
MA931M70	70	108	86	35	160	6700	1
MA931M73	73	110	86	35	170	7800	1
MA931M75	75	110	86	35	170	7800	1
MA931M76	76	115	86	35	170	8200	1
MA931M78	78	116	86	38	170	8200	1
MA931M80	80	125	86	41	170	8600	1
MA931M85	85	130	86	44	170	9900	1
MA931M90	90	130	86	44	170	8400	1
MA931M95	95	137	95	46	180	12200	1
MA931M100	100	144	95	48	190	14100	1
MA931M105	105	150	95	51	190	15800	1
MA931M110	110	156	95	54	200	17000	1
MA931M115	115	160	95	56	200	20400	1
MA931M120	120	168	95	58	210	21500	1
MA931M125	125	168	95	80	210	13200	1

AD-22/23/24

MAGNETIC ALUMINUM RAIL

48 pieces in one carton



M7 NO.	Drive	Total Length	⚖	📦	
	inch	inch	mm	g	
AD-2212	1/4"	12"	300	25	10
AD-2312	3/8"	12"	300	25	10
AD-2412	1/2"	12"	300	25	10
AD-2218	1/4"	18"	457	26	10
AD-2318	3/8"	18"	457	26	10
AD-2418	1/2"	18"	457	26	10

3/4" MA641M

4 POINT SQUARE IMPACT SOCKET

- 3/4" Drive Deep Length
- 4 Points
- Metric Size



M7 NO.	Ø	D1	D2	L	⚖
	mm	mm	mm	mm	g
MA641M17	17	37	44	52	320
MA641M19	19	39	44	52	320
MA641M20	20	41	44	52	350
MA641M21	21	42	44	52	350

3/4" MA641S

4 POINT SQUARE IMPACT SOCKET

- 3/4" Drive Deep Length
- 4 Points
- Inch Size



M7 NO.	Ø	D1	D2	L	⚖
	inch	mm	mm	mm	g
MA641S24	3/4"	37	44	52	320
MA641S26	13/16"	39	44	52	320

3/4" MA643M

4 POINT SQUARE IMPACT SOCKET

- 3/4" Drive Deep Length
- 4 Points
- Metric Size



M7 NO.	Ø	D1	D2	L	⚖
	mm	mm	mm	mm	g
MA643M17	17	37	44	90	600
MA643M19	19	39	44	90	620
MA643M20	20	41	44	90	660
MA643M21	21	42	44	90	670
MA643M22	22	42	44	90	670

1" MA841M

4 POINT SQUARE IMPACT SOCKET

- 1" Drive Deep Length
- 4 Points
- Metric Size



M7 NO.	Ø	D1	D2	L	⚖
	mm	mm	mm	mm	g
MA841M17	17	40	54	57	360
MA841M19	19	43	54	57	360
MA841M20	20	45	54	57	390
MA841M21	21	47	54	57	390
MA841M22	22	47	54	57	390

1" MA841S

4 POINT SQUARE IMPACT SOCKET

- 1" Drive Deep Length
- 4 Points
- Inch Size



M7 NO.	Ø	D1	D2	L	⚖
	inch	mm	mm	mm	g
MA841S24	3/4"	43	54	57	380
MA841S26	13/16"	47	54	57	390
MA841S30	15/16"	48	54	57	430

1" MA843M

4 POINT SQUARE IMPACT SOCKET

- 1" Drive Deep Length
- 4 Points
- Metric Size



M7 NO.	Ø	D1	D2	L	⚖
	mm	mm	mm	mm	g
MA843M17	17	40	54	76	680
MA843M19	19	43	54	76	700
MA843M20	20	45	54	76	720
MA843M21	21	47	54	76	740
MA843M22	22	47	54	76	740

IMPACT SOCKET

MA412M1719 DOUBLE SIDED SOCKET



2" Extended Anvil matching special double sided socket 17mm & 19mm specifically for automotive tyres.

MA412M2122 DOUBLE SIDED SOCKET



2" Extended Anvil matching special double sided socket 21mm & 22mm specifically for automotive tyres.

MA412S2426 DOUBLE SIDED SOCKET



2" Extended Anvil matching special double sided socket 24mm & 26mm specifically for automotive tyres.

ME271M08-7 EXTENSION BIT SOCKET

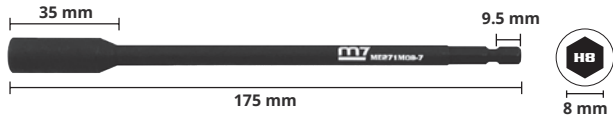

ME271M10-7 EXTENSION BIT SOCKET

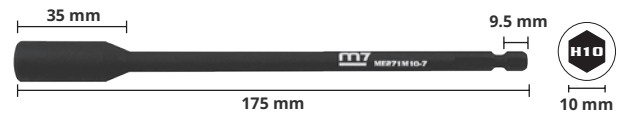

SOCKET PACK

100 pieces in one carton

M7 NO.	Drive
	inch
8702-1	1/4"
8703-1	3/8"
8704-1	1/2"
8706-1	3/4"
8708-1	1"



SOCKET STICKERS PACK

100 pieces in one carton

M7 NO.	Drive
	inch
8702	1/4"
8703	3/8"
8704	1/2"
8706	3/4"
8708	1"



MALE ADAPTER

Without Ball : ME486H, ME688H, ME684H, ME886H

M7 NO.	Spec	D	L		
	inch	mm	mm	g	
ME382	3/8" F x 1/4" M	22	32	12	50
ME384	3/8" F x 1/2" M	22	32	50	50
ME483	1/2" F x 3/8" M	25	38	65	50
ME486	1/2" F x 3/4" M	30	48	161	50
ME486H	1/2" F x 3/4" M	30	48	161	50
ME684	3/4" F x 1/2" M	44	60	343	50
ME684H	3/4" F x 1/2" M	44	60	343	50
ME688	3/4" F x 1" M	46	68	437	50
ME688H	3/4" F x 1" M	46	68	437	50
ME886	1" F x 3/4" M	56	80	653	25
ME886H	1" F x 3/4" M	56	80	653	25
ME889	1" F x 1-1/2" M	54	90	1078	25



UNIVERSAL JOINT

Without Ball : ME6711H, ME8711H

M7 NO.	Size	D	Total Length			
			inch	mm		
ME2711	1/4"	20	1-3/4"	65	42	10
ME3711	3/8"	27	2"	51	102	10
ME4711	1/2"	34	2-7/16"	61	208	10
ME6711	3/4"	49	3-1/2"	90.4	641	10
ME6711H	3/4"	49	3-1/2"	90.4	641	10
ME8711	1"	59	4-1/2"	114	1199	10
ME8711H	1"	59	4-1/2"	114	1199	10
ME9711	1-1/2"	90	6-11/16"	170	1312	10



1/4" ME221 EXTENSION BAR

M7 NO.	Total Length			
	inch	mm		
ME221-02	2"	50	26	10
ME221-04	4"	100	46	10
ME221-06	6"	150	67	10



3/8" ME321 EXTENSION BAR

M7 NO.	Total Length			
	inch	mm		
ME321-03	3"	75	79	10
ME321-05	5"	125	124	10
ME321-06	6"	150	140	10
ME321-10	10"	250	242	10
ME321-12	12"	300	288	10
ME321-15	15"	375	354	10



1/2" ME421

EXTENSION BAR

Without Ball : ME421-05H, ME421-10H

M7 NO.	Total Length		⚖	📦
	inch	mm		
ME421-03	3"	75	142	10
ME421-05	5"	125	228	10
ME421-05H	5"	125	228	10
ME421-06	6"	150	269	10
ME421-07	7"	175	310	10
ME421-08	8"	200	345	10
ME421-10	10"	250	653	10
ME421-10H	10"	250	653	10
ME421-15	15"	375	1041	10



3/4" ME621

EXTENSION BAR

Without Ball : ME621-04H, ME621-06H, ME621-07H, ME621-10H, ME621-13H

M7 NO.	Total Length		⚖	📦
	inch	mm		
ME621-04	4"	100	609	10
ME621-04H	4"	100	609	10
ME621-06	6"	150	813	10
ME621-06H	6"	150	813	10
ME621-07	7"	175	911	10
ME621-07H	7"	175	911	10
ME621-08	8"	200	929	10
ME621-10	10"	250	1200	10
ME621-10H	10"	250	1200	10
ME621-13	13"	330	1480	10
ME621-13H	13"	330	1480	10



1" ME821

EXTENSION BAR

Without Ball : ME821-07H, ME821-10H, ME821-13H

M7 NO.	Total Length		⚖	📦
	inch	mm		
ME821-03	3"	75	727	10
ME821-06	6"	150	1330	10
ME821-07	7"	175	1520	10
ME821-07H	7"	175	1520	10
ME821-08	8"	200	1705	10
ME821-10	10"	250	2050	10
ME821-10H	10"	250	2050	10
ME821-12	12"	300	2382	10
ME821-13	13"	330	2550	10
ME821-13H	13"	330	2550	10



ME4050

EXTENSION BAR

Contents : ME422-090, ME422-110, ME422-122, ME422-137, ME422-151



ME422

EXTENSION BAR

1/2" Drive torque



M7 NO.	Color	Total Length		D	Torque	⚖	📦
		mm	mm				
ME422-090	Yellow	194	9	65/90	236	10	
ME422-110	Blue	194	11	80/110	231	10	
ME422-122	Gray	194	12.2	100/135	258	10	
ME422-137	White	194	13.7	120/160	300	10	
ME422-151	Sky nature	194	15.1	140/190	306	10	
ME422-103	Black	194	10.3	75/100	224	10	
ME422-114	Beige	194	11.4	90/120	242	10	
ME422-128	Orange	194	12.8	110/150	269	10	

1/2" ME904

1/2" DRIVE LOCKING RING

1/2" DRIVE LOCKING PIN



M7 NO.	Desp.	Ø	d2	ℓ	Applied to socket sizes
ME90424	Ring	3.5	19		8~19mm
ME90424	Pin	3	20		(3/16"~9/16")
ME90436	Ring	3.5	23		15~46mm
ME90436	Pin	3	25		(5/8"~1-1/4")

3/4" ME906

3/4" DRIVE LOCKING RING

3/4" DRIVE LOCKING PIN



M7 NO.	Desp.	Ø	d2	ℓ	Applied to socket sizes
ME90627	Ring	3.5	33		17~30mm
ME90627	Pin	3	30		(11/16"~1-3/16")
ME90646	Ring	5.5	37		17~46mm
ME90646	Pin	4	35		(1-1/16"~1-13/16")
ME90650	Ring	5.5	44		48mm~65mm
ME90650	Pin	4	45		(1-7/8"~2-3/8")

1" ME908

1" DRIVE LOCKING RING

1" DRIVE LOCKING PIN



M7 NO.	Desp.	Ø	d2	ℓ	Applied to socket sizes
ME90836	Ring	5.5	48		19~70mm
ME90836	Pin	5	45		(3/4"~2-3/4")
ME90860	Ring	10	75		71~90mm
ME90860	Pin	5	75		(2-13/16"~3-1/2")

IMPACT SOCKET

IMPACT SOCKET

3/8" ME371S

IMPACT HEX BITS

M7 NO.	Hex	D2	L	Weight		Box
				g	lb	
	inch	mm	mm	g	lb	
ME371S06	3/16"	19	60	50	300	
ME371S07	7/32"	19	60	52	300	
ME371S08	1/4"	19	60	70	300	
ME371S09	9/32"	19	60	75	300	
ME371S10	5/16"	19	60	80	300	
ME371S12	3/8"	19	60	90	300	
ME371S14	7/16"	19	60	90	300	
ME371S16	1/2"	19	60	100	300	
ME371S18	9/16"	19	60	115	300	
ME371S20	5/8"	19	60	120	300	



3/8" ME371M

IMPACT HEX BITS

M7 NO.	Hex	D2	L	Weight		Box
				g	lb	
	mm	mm	mm	g	lb	
ME371M04	4	19	60	50	300	
ME371M05	5	19	60	50	300	
ME371M06	6	19	60	65	300	
ME371M07	7	19	60	75	300	
ME371M08	8	19	60	80	300	
ME371M09	9	19	60	85	300	
ME371M10	10	19	60	90	300	
ME371M11	11	19	60	90	300	
ME371M12	12	19	60	95	300	
ME371M13	13	19	60	100	300	
ME371M14	14	19	60	110	300	
ME371M15	15	19	60	115	300	
ME371M16	16	19	60	120	300	
ME371M17	17	19	60	150	300	
ME371M19	19	19	60	170	300	



1/2" ME471S

IMPACT HEX BIT 1/2" Drive inch size SAE

M7 NO.	Hex	Total Length	Weight		Box
			g	lb	
	inch	mm	g	lb	
ME471S06	3/16"	78	90	10	
ME471S07	7/32"	78	90	10	
ME471S08	1/4"	78	69	10	
ME471S09	9/32"	78	95	10	
ME471S10	5/16"	78	94	10	
ME471S11	11/32"	78	100	10	
ME471S12	3/8"	78	105	10	
ME471S14	7/16"	78	119	10	
ME471S16	1/2"	78	134	10	
ME471S18	9/16"	78	151	10	
ME471S20	5/8"	78	173	10	
ME471S22	11/16"	78	194	10	
ME471S24	3/4"	78	215	10	
ME471S26	13/16"	78	229	10	



1/2" ME471M

IMPACT HEX BIT 1/2" Drive metric size

M7 NO.	Hex	Total Length	Weight		Box
			g	lb	
	mm	mm	g	lb	
ME471M04	4	78	71	100	
ME471M05	5	78	77	100	
ME471M06	6	78	81	100	
ME471M07	7	78	87	100	
ME471M08	8	78	95	100	
ME471M09	9	78	102	100	
ME471M10	10	78	108	100	
ME471M11	11	78	118	100	
ME471M12	12	78	128	100	
ME471M13	13	78	140	100	
ME471M14	14	78	149	100	
ME471M15	15	78	166	100	
ME471M16	16	78	177	100	
ME471M17	17	78	188	100	
ME471M18	18	78	202	100	
ME471M19	19	78	215	100	
ME471M20	20	78	173	100	
ME471M21	21	78	233	100	
ME471M22	22	78	194	50	



3/4" ME671S

IMPACT HEX BITS SOCKET

3/4" Drive inch size

M7 NO.	Hex	Total Length	Weight		Box
			g	lb	
	inch	mm	g	lb	
ME671S12	3/8"	480	480	35	
ME671S14	7/16"	500	500	35	
ME671S16	1/2"	510	510	35	
ME671S18	9/16"	520	520	35	
ME671S20	5/8"	530	530	35	
ME671S22	11/16"	540	540	35	
ME671S24	3/4"	600	600	30	
ME671S26	13/16"	610	610	30	
ME671S28	7/8"	620	620	30	
ME671S30	15/16"	690	690	30	
ME671S32	1"	680	680	25	
ME671S34	1-1/16"	720	720	15	
ME671S36	1-1/8"	740	740	15	
ME671S38	1-3/16"	830	830	10	
ME671S40	1-1/4"	850	850	10	



3/4" ME671M

IMPACT HEX BITS SOCKET

3/4" Drive metric size

M7 NO.	Hex	Total Length	Weight		Box
			g	lb	
	mm	mm	g	lb	
ME671M10	10	100	490	35	
ME671M12	12	100	510	35	
ME671M14	14	100	520	35	
ME671M17	17	100	540	35	
ME671M19	19	100	600	35	
ME671M21	21	100	610	25	
ME671M22	22	100	620	25	
ME671M24	24	100	690	25	
ME671M27	27	100	720	20	
ME671M30	30	100	830	20	
ME671M32	32	100	850	20	



1" ME871M

IMPACT HEX BITS SOCKET

M7 NO.	mm	Total Length		g	10
		mm	g		
ME871M14	14	78	81	10	10
ME871M17	17	78	87	10	10
ME871M19	19	78	95	10	10
ME871M22	22	78	102	10	10
ME871M24	24	78	108	10	10
ME871M27	27	78	118	10	10
ME871M30	30	78	128	10	10
ME871M32	32	78	140	10	10
ME871M36	36	78	1100	10	10
ME871M41	41	78	---	---	10



1/2" ME473M

HEX BALL DRIVE IMPACT SOCKET **NEW**

M7 NO.	mm	D2	L	g	
				g	10
ME473M04	H4	25	78	78	---
ME473M05	H5	25	78	82	---
ME473M06	H6	25	78	86	---
ME473M07	H7	25	78	90	---
ME473M08	H8	25	78	93	---
ME473M10	H10	25	78	105	---
ME473M12	H12	25	78	118	---
ME473M14	H14	25	78	131	---
ME473M15	H15	25	78	140	---
ME473M16	H16	25	78	151	---
ME473M17	H17	25	78	161	---
ME473M18	H18	25	78	171	---
ME473M19	H19	25	78	182	---



3/4" ME673M

IMPACT HEX BALL BIT SOCKET **NEW**

M7 NO.	mm	D2	L	g	
				g	---
ME673M14	H14	44	100	463	---
ME673M17	H17	44	100	489	---
ME673M19	H19	44	100	508	---
ME673M21	H21	44	100	540	---
ME673M22	H22	44	100	554	---
ME673M24	H24	44	100	588	---
ME673M27	H27	44	100	643	---
ME673M30	H30	44	100	701	---
ME673M32	H32	44	100	741	---



3/8" ME371T

STAR BIT SOCKET

M7 NO.	T	mm	L	g	
				g	---
ME371T10	T10	19	60	71	300
ME371T15	T15	19	60	71	300
ME371T20	T20	19	60	68	300
ME371T25	T25	19	60	74	300
ME371T27	T27	19	60	76	300
ME371T30	T30	19	60	76	300
ME371T40	T40	19	60	81	300
ME371T45	T45	19	60	85	300
ME371T47	T47	19	60	85	300
ME371T50	T50	19	60	87	300
ME371T55	T55	19	60	106	300
ME371T60	T60	19	60	118	300
ME371T70	T70	19	60	135	300



1/2" ME471T

STAR BIT SOCKET

1/2" Drive Deep Length
6 Points
Inch Size

M7 NO.	T	mm	L	g	
				g	1
ME471T10	T10	25	78	71	1
ME471T15	T15	25	78	71	1
ME471T20	T20	25	78	68	1
ME471T25	T25	25	78	74	1
ME471T27	T27	25	78	76	1
ME471T30	T30	25	78	76	1
ME471T40	T40	25	78	81	1
ME471T45	T45	25	78	85	1
ME471T47	T47	25	78	85	1
ME471T50	T50	25	78	87	1
ME471T55	T55	25	78	106	1
ME471T60	T60	25	78	118	1
ME471T70	T70	25	78	135	1
ME471T80	T80	25	78	155	1
ME471T90	T90	25	78	155	1
ME471T100	T100	25	78	155	1



DRIVE BIT HOLDER

M7 NO.	Drive	Hex	g	
			g	10
MB371S08	3/8"	1/4"	43	10
MB471S08	1/2"	1/4"	76	10
MB471S10	1/2"	5/16"	78	10
MB471M10	1/2"	10 mm	80	10



1/2" ME472S

1/2" DRIVE BIT HOLDER
QUICK CHANGE

M7 NO.	Drive	Hex	g	
			g	50
ME472S08	1/2"	1/4"	118	50



AFTER MARKET SUPPORT

AFTER MARKET SUPPORT

AD-3511P Display security steel wire rope AD-3511T Hook type base

HOOK TYPE BASE WITH CARD DISPLAY & DISPLAY SECURITY STEEL WIRE ROPE















Contents :

- AD-3511P :
1 x Display security steel wire rope
2 x L Hex wrench
1 x Hex socket screws
- AD-3511T :
1 x Acrylic card case hook type base

















Item No.	Adaptor Type	Contents			
 AD-3511	Europe	 SY-211M	 AD-3521		 AD-3511T
 AD-3512	Japan	 SY-221M	 AD-3522		 AD-3511T
 AD-3513	U.S.A	 SY-231M	 AD-3523		 AD-3511T

AD-35 COMPLETE SET OF TOOL BASE

Item No.	Adaptor Type	Contents			
 AD-3501	Europe	 SY-211M	 AD-3521		 AD-351
 AD-3502	Japan	 SY-221M	 AD-3522		 AD-351
 AD-3501	U.S.A	 SY-231M	 AD-3521		 AD-351

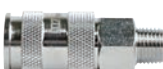
AD-36 COMPLETE SET OF TOOL BASE

Item No.	Adaptor Type	Contents			
 AD-3601	Europe	 SY-211M	 AD-3521		 AD-305-41
 AD-3602	Japan	 SY-221M	 AD-3522		 AD-305-41
 AD-3601	U.S.A	 SY-231M	 AD-3521		 AD-305-41

AD-309 DISPLAY BOARD

1 pieces in one carton

Nice m7 brand image is conducive to small space display hanging tools.
Can also be used as a gift to the user to hang the tools.

Overall Size(mm)
Width x Depth x Height

725 x 14 x 900
weight : 11.5 kg



AD-307 WALL TYPE DISPLAY STAND

Powder Coating
Attachment
1pc Brand Plate
2pcs Angled Steel Frame
2pcs Shelf
1pc Bottom Shelf
4pcs Steel Plate With Hole

Overall Size(mm)
Width x Depth x Height

900 x 500 x 2230

AD-303-41 Hooks



AD-351 OPTIONAL ITEM



AD-361 OPTIONAL ITEM

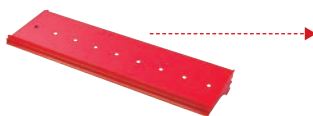

Overall Size(mm)
Width x Depth

280 x 910

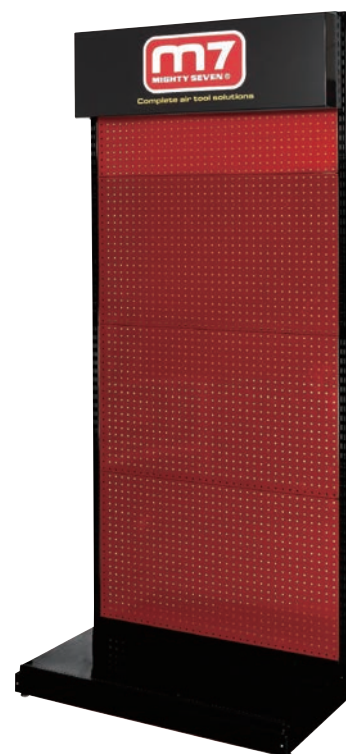

AD-308 TOWER TYPE DISPLAY STAND

1pc Transparent DM Shelf
2pcs Support Frame
1pc Bottom Shelf



AD-305-41 OPTIONAL ITEM

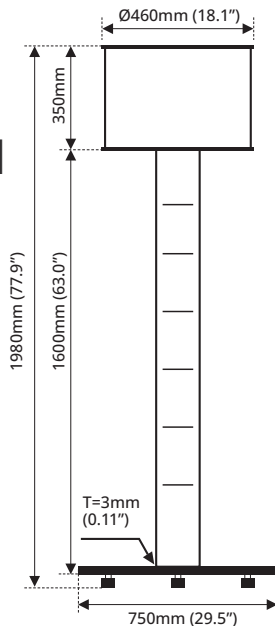

ST-10C521 ST-10C522S

USER DIY ASSEMBLED MOBILE WORKING CHAIR

Color : red/black anti scratch paint
Seat cushion materials : high graded artificial PVC leather with sponge
Product sizes : long 350mm width 260mm height 240mm, excl.
Wheels drawer height : 70mm
Product feature : storage daily needed tools reduce squatting fatigue, movable willingly.



ST-10C521



ST-10C522
1 Drawer Design

Contains	Package			
	Net Weight	Gross Weight	Length	Width
Lamp Case Set	kg	kg	mm	mm
Display Pillar	10.6	11.6	760 750	20
Display Stand Bottom Plate	16.5	17.5	860 310	150
	5.6	6.2	500 460	90

DISPLAY CASE

SF-306/SF-604/SF-605

SPARE PARTS BOX

greasy-resisting
wearproof

	Overall Size(mm) Width x Depth x Height
SF-306	303 x 106 x 253 (11.8"x4.1"x11")
SF-604	603 x 167 x 203 (23.7"x6.5"x8")
SF-605	603 x 123 x 153 (23.7"x4.8"x6")



SF-306



SF-604



SF-605

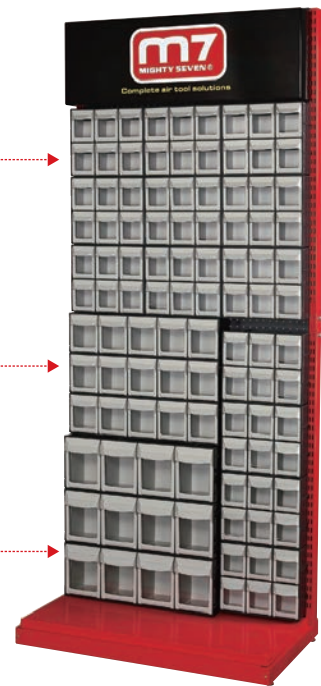

AD-101

CORDLESS TOOLS DISPLAY



AD-306

TABLE TYPE DISPLAY STAND

1 pc Transparent DM shelf
2 pcs support frame
1 pc Bottom shelf
3 set (AD-3521/3522/3523)

Overall Size(mm)
Width x Depth x Height

300 x 140 x 340



AD-306DB

TABLE DISPLAY FOR CORDLESS TOOL



AD-316

NEW

TABLE DISPLAY FOR CORDLESS TOOL (2 Sets)



AD-431

1/2" DR. SOCKET SHELF SET



AD-201

1/2" DR. SOCKET SHELF SET



SH-1001

AIR TOOL HOLDER



ACCESSORIES

MC-REPAIR KIT

Replacement Parts



NE-REPAIR KIT

Replacement Parts



PA-MC

Automatic Mandrel Collection

3/32"(2.4mm) 220pcs
1/8" (3.2mm) 160pcs
5/32"(4.0mm) 110pcs
3/16"(4.8mm) 80pcs



PE-MC

Standard Safety Tip



PC-901

Adjustable Toeque Air Tapping Adapter

HEX:8mm

For : Air Drill / Electricity Drill / Cordless Drill / Drill Machine

Blister+Card



NON-VACCUM VELCRO

Backing Face : velcro



ITEM NO.	SIZE	Max R.P.M
QB-9302	2"	15000
QB-9303	3"	15000
QB-9305	5"	12000
QB-9306	6"	12000

Blister+Card



SIX HOLE

Backing Face : velcro
velcro & vinyl are both available

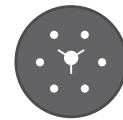

ITEM NO.	SIZE	Max R.P.M
QB-9315 (velcro)	5"	12000
QB-9355 (vinyl)	5"	10000
QB-9316 (velcro)	6"	12000
QB-9356 (vinyl)	6"	12000

Blister+Card



NON-VACCUM VINYL

Backing Face : vinyl



ITEM NO.	SIZE	Max R.P.M
QB-9345	5"	12000
QB-9346	6"	12000

Blister+Card



FIFTEEN HOLE

Backing Face : velcro
velcro & vinyl are both available

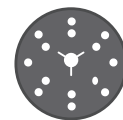

ITEM NO.	SIZE	Max R.P.M
QB-9327 (velcro)	6"	12000
QB-9366 (vinyl)	6"	12000

Blister+Card



ACCESSORIES

ACCESSORIES

QB-9303

3" Sanding Pad



QB-9320

PAD
FOR QK-111 QK-121



QB-9337M

7" Sanding Pad



QB-9337S

7" Sanding Pad



ITEM NO.	Size	Max R.P.M	Thread Size	For M7 Item No.
QB-9337M	7"	15,000	M14 x 2.0	QP-307 QP-327
QB-9337S	7"	15,000	5/8" x 11	QP-317

QB-922

2" Roll On Holder



QB-923

3" Roll On Holder



QB-9802 QB-9803

Stripping Disc



QB-9712K QB-9713K

Stripping Disc
Use on QB-922 & QB-923
Roll-on holder



5 pcs / 1 SET

Bag+Card

ITEM NO.	Size	Max R.P.M	For M7 Item No.
QB-922	2"	30,000	QP-212 QP-213
QB-923	3"	20,000	QP-223 QB-625

ITEM NO.	SIZE	R.P.M
QB-9802	2"	15,000
QB-9803	3"	15,000

ITEM NO.	SIZE	R.P.M
QB-9712K	2"	15,000
QB-9713K	3"	15,000

QB-801

Eraser Wheel



QB-9401

Wire Wheel



QB-9434 FOR GLOBAL QB-9434U FOR USA ONLY

Eraser Wheel
Available with QB-812T



QB-9444 FOR GLOBAL QB-9444U FOR USA ONLY

Eraser Wheel
Available with QB-802 & QB-812



QB-904/QB-905/QB-907

Grinding Wheel Materials: Aluminum Oxide



ITEM NO.	Specification		
0QB-904	100 x 6 x 16 4" x 1/4" x 5/8" 102mm	25	200
0QB-905	125 x 6 x 22 5" x 1/4" x 7/8" 127mm	25	200
0QB-907	180 x 6 x 22 7" x 1/4" x 7/8" 128mm	25	200

QB-913/QB-914

Cut-off Wheel



ITEM NO.	Specification		
0QB-913	75 x 1.5 x 10 3" x 1/16" x 3/8" 76mm	50	200
0QB-914	100 x 1.5 x 10 4" x 1/16" x 3/8" 102mm	50	200

QB-95 SERIES

Wool Bonnet PAD



Bag+Card

ITEM NO.	Size	PS.
0QB-9512	2"	Velcro
0QB-9513	3"	Velcro
0QB-9515	5"	Velcro
0QB-9517	7"	Velcro
0QB-9507	7"	Tie Cords

QB-94 SERIES

Sponge



Bag+Card

ITEM NO.	Size	PS.	Thickness	PS.
0QB-9402	2"	Yellow / Rough	25mm	Velcro
0QB-9422	2"	White / Medium	25mm	
0QB-9403	3"	Yellow / Rough	25mm	
0QB-9413	3"	White / Medium	25mm	
0QB-9404	4"	Yellow / Rough	25mm	
0QB-9414	4"	White / Medium	25mm	
0QB-9405	5"	Yellow / Rough	25mm	
0QB-9415	5"	White / Medium	25mm	
0QB-9406	6"	Yellow / Rough	25mm	
0QB-9416	6"	White / Medium	25mm	
0QB-9407	7"	Yellow / Rough	25mm	
0QB-9417	7"	White / Medium	25mm	

PAD DIE Series

5 pcs / 1 SET

Use on QB-922 & QB-923



Blister+Card



ITEM NO.	Size	PS.	Max R.P.M
QB-9702k-24	2"	Grit:#24	30,000
QB-9702k-40		Grit:#40	
QB-9702k-60		Grit:#60	
QB-9702k-80		Grit:#80	
QB-9702k-100		Grit:#100	
QB-9702k-120		Grit:#120	
QB-9702k-150		Grit:#150	
QB-9702k-180		Grit:#180	
QB-9702k-240		Grit:#240	
QB-9703k-24		3"	
QB-9703k-40	Grit:#40		
QB-9703k-60	Grit:#60		
QB-9703k-80	Grit:#80		
QB-9703k-100	Grit:#100		
QB-9703k-120	Grit:#120		
QB-9703k-150	Grit:#150		
QB-9703k-180	Grit:#180		
QB-9703k-320	Grit:#320		

PAD DIE Series

5 pcs / SET

Use on QB-922 & QB-923



Blister+Card



ITEM NO.	Size	PS.	Max R.P.M
QB-9712-YL	2"	Yellow-Coarse #80	30,000
QB-9712-RD	2"	Red-Medium #150	
QB-9712-BL	2"	Blue-Fine #300	
QB-9713-YL	3"	Yellow-Coarse #80	
QB-9713-RD	3"	Red-Medium #150	
QB-9713-BL	3"	Blue-Fine #300	

ACCESSORIES

ACCESSORIES

QB-9303K04

3" Sander / Buffer Versatility Kit

Thread : 5/16" x 24
MAX : 15,000 R.P.M

For QP-113 / QP-123 / QP-213 / QP-223



Blister+Card

CONTENTS :

3" Sanding Pad x 1PC
3" Foam Yellow x 1PC
3" Foam White x 1PC
3" Wool Bonnet x 1PC
Max R.P.M : 15,000
Backing Face :
Velcro Available

QB-974K12

2" & 3" Surface Sanding Kit

2" Max : 30,000 R.P.M
3" Max : 20,000 R.P.M

For QA Series Die Grinder



Blister+Card

SHANK TYPE

QB-974K12A : 6mm
QB-974K12B : 1/4"

CONTENTS :

Shank x 2 PC (A or B)
2" Rollon Holder x 1PC
3" Rollon Holder x 1PC
2" Sanding Disc x 4PCS
3" Sanding Disc x 4PCS

QB-9743K20

3" Surface Sanding Kit

MAX : 20,000 R.P.M

For QA Series Die Grinder



Blister+Card

SHANK TYPE

QB-9743K20A : 6mm
QB-9743K20B : 1/4"

CONTENTS :

Shank x 1 PC (A or B)
3" Rollon Holder x 1PC
3" Pad Die x 15PCS
3" Sanding Disc x 3PCS

QB-9742K20

2" Surface Sanding Kit

MAX : 30,000 R.P.M

For QA Series Die Grinder



Blister+Card

SHANK TYPE

QB-9742K20A : 6mm
QB-9742K12B : 1/4"

CONTENTS :

Shank x 1 PC (A or B)
2" Rollon Holder x 1PC
2" Pad Die x 15PCS
2" Sanding Disc x 3PCS

QB-9742K12

2" Surface Sanding Kit

MAX : 30,000 R.P.M

For QA Series Die Grinder



Blister+Card

CONTENTS :

Shank x 1 PC (A or B)
2" Rollon Holder x 1PC
2" Pad Die x 6PCS
2" Sanding Disc x 3PCS
2" Stripping Disc x 1PC

QB-9743K12

3" Surface Sanding Kit

MAX : 20,000 R.P.M

For QA Series Die Grinder



Blister+Card

SHANK TYPE

QB-9743K12A : 6mm
QB-9743K12B : 1/4"

CONTENTS :

Shank x 1 PC (A or B)
3" Rollon Holder x 1PC
3" Pad Die x 6PCS
3" Sanding Disc x 3PCS
3" Stripping Disc x 1PC

QB-9773K19

3" Polishing Sponge Kit

MAX : 15,000 R.P.M

For QA Series Die Grinder



Blister+Card

SHANK TYPE

QB-9773K19A : 6mm
QB-9773K19B : 1/4"

CONTENTS :

Shank x 1 PC (A or B)
3" Sanding Pad x 1PC
3" Sanding Sponge x 6PCS
3" Sanding Paper x 10PCS
3" Polishing Sponge x 2PCS

QB-9752K07

2" Felt Pad Conditioning Disc Kit

MAX : 20,000 R.P.M

For QA Series Die Grinder



Blister+Card

SHANK TYPE

QB-9752K07A : 6mm
QB-9752K07B : 1/4"

CONTENTS :

2" Felt Pad x 6PCS

QB-9762K07

2" Surface Pad Conditioning Disc Kit

MAX : 20,000 R.P.M

For QA Series Die Grinder



Blister+Card

SHANK TYPE

QB-9762K07A : 6mm
QB-9762K07B : 1/4"

CONTENTS :

Shank x 1 PC (A or B)
2" Stripping Disc x 2PCS

2" CONDITIONING DISC :

Red x 2PCS
Grey x 2PCS

QB-911 [SET] QB-912 [SET]

Abrasive Cloth Belt

QB-91108
QB-91210
Available with
For QB-311 / QB-321

QB-91110
QB-91210
Available with
For QB-312 / QB-322 / QB-322C



Blister+Card

ITEM NO.	Belt Size		For M7 Item NO.
QB-91108	10mm x 330mm #80	10Pcs/1 Set	QB-311
QB-91110	10mm x 330mm #100	10Pcs/1 Set	QB-321
QB-91208	20mm x 520mm #80	10Pcs/1 Set	QB-322
QB-91210	20mm x 520mm #100	10Pcs/1 Set	QB-322C QB-312

QB-9211A/B [SET]

Grinder Stone Set
A(3mm shank)B(1/8" shank)

Available with
QA-633Q, QA-611, QA-632Q, QA-111, QA-211, QA-231Q,
QA-311, QA-313, QA-315



Blister+Card

QB-9213A/B [SET]

Grinder Stone Set
A(6mm shank)B(1/4" shank)

Available with
M7 All Air Die Grinder



Blister+Card

QB-9933V

Velcro Triangular
Sandpaper Set



ITEM NO.	Size	PS.	Item NO.	pcs / set
0QB-9933V-04K50	3-1/5" (81.6mm)	Grit:#40	DOM-101 QK-131	50
0QB-9933V-06K10		Grit:#60		10
0QB-9933V-06K50		Grit:#60		50
0QB-9933V-08K50		Grit:#80		50
0QB-9933V-10K10		Grit:#100		10
0QB-9933V-10K50		Grit:#100		50

SANDING PAPER SERIES

Velcro / Self-Adhesive
Six hole / Non-Vacuum

5 pcs or 10 pcs / 1 SET

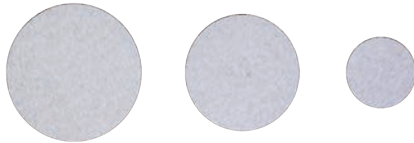

Self-Adhesive

ITEM NO.	Size	PS.	Velcro / Self-AD	For M7 Item NO.	Holes	pcs / set	MOQ
0QB-9913S-08K10	3"	Grit:#80	Self-Adhesive	QP-113 QP-123	Non	10	
0QB-9913S-15K10		Grit:#150					
0QB-9913S-18K10		Grit:#180					
0QB-9913S-32K10		Grit:#320					
0QB-9913S-40K10		Grit:#400					
0QB-9915S-08K5	5"	Grit:#80	Self-Adhesive	QB-41 QB-42 QB-43 QB-45 QB-46 QB-47 QB-51 QB-52 QB-53 QB-54 QB-56 QB-57 QB-58 QB-59	Non	5	100 Set
0QB-9915S-15K5		Grit:#150					
0QB-9915S-18K5		Grit:#180					
0QB-9915S-32K5		Grit:#320					
0QB-9915S-40K5		Grit:#400					
0QB-9916S-08K5	6"	Grit:#80	Self-Adhesive	QB-41 QB-42 QB-43 QB-45 QB-46 QB-47 QB-51 QB-52 QB-53 QB-54 QB-56 QB-57 QB-58 QB-59	Non	5	100 Set
0QB-9916S-15K5		Grit:#150					
0QB-9916S-18K5		Grit:#180					
0QB-9916S-32K5		Grit:#320					
0QB-9916S-40K5		Grit:#400					
0QB-9905S-08K5	5"	Grit:#80	Self-Adhesive	QB-41 QB-42 QB-43 QB-45 QB-46 QB-47 QB-51 QB-52 QB-53 QB-54 QB-56 QB-57 QB-58 QB-59	6	5	100 Set
0QB-9905S-15K5		Grit:#150					
0QB-9905S-18K5		Grit:#180					
0QB-9905S-32K5		Grit:#320					
0QB-9905S-40K5		Grit:#400					
0QB-9906S-08K5	6"	Grit:#80	Self-Adhesive	QB-41 QB-42 QB-43 QB-45 QB-46 QB-47 QB-51 QB-52 QB-53 QB-54 QB-56 QB-57 QB-58 QB-59	6	5	100 Set
0QB-9906S-15K5		Grit:#150					
0QB-9906S-18K5		Grit:#180					
0QB-9906S-32K5		Grit:#320					
0QB-9906S-40K5		Grit:#400					

Velcro

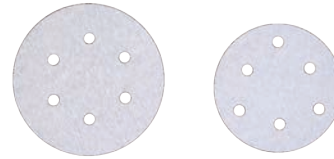

ITEM NO.	Size	PS.	Velcro / Self-AD	For M7 Item NO.	Holes	pcs / set	MOQ
0QB-9913V-08K10	3"	Grit:#80	Velcro	QP-113 QP-123	Non	10	
0QB-9913V-15K10		Grit:#150					
0QB-9913V-18K10		Grit:#180					
0QB-9913V-32K10		Grit:#320					
0QB-9913V-40K10		Grit:#400					
0QB-9915V-08K5	5"	Grit:#80	Velcro	QB-41 QB-42 QB-43 QB-45 QB-46 QB-47 QB-51 QB-52 QB-53 QB-54 QB-56 QB-57 QB-58 QB-59	Non	5	100 Set
0QB-9915V-15K5		Grit:#150					
0QB-9915V-18K5		Grit:#180					
0QB-9915V-32K5		Grit:#320					
0QB-9915V-40K5		Grit:#400					
0QB-9916V-08K5	6"	Grit:#80	Velcro	QB-41 QB-42 QB-43 QB-45 QB-46 QB-47 QB-51 QB-52 QB-53 QB-54 QB-56 QB-57 QB-58 QB-59	Non	5	100 Set
0QB-9916V-15K5		Grit:#150					
0QB-9916V-18K5		Grit:#180					
0QB-9916V-32K5		Grit:#320					
0QB-9916V-40K5		Grit:#400					
0QB-9905V-08K5	5"	Grit:#80	Velcro	QB-41 QB-42 QB-43 QB-45 QB-46 QB-47 QB-51 QB-52 QB-53 QB-54 QB-56 QB-57 QB-58 QB-59	6	5	100 Set
0QB-9905V-15K5		Grit:#150					
0QB-9905V-18K5		Grit:#180					
0QB-9905V-32K5		Grit:#320					
0QB-9905V-40K5		Grit:#400					
0QB-9906V-08K5	6"	Grit:#80	Velcro	QB-41 QB-42 QB-43 QB-45 QB-46 QB-47 QB-51 QB-52 QB-53 QB-54 QB-56 QB-57 QB-58 QB-59	6	5	100 Set
0QB-9906V-15K5		Grit:#150					
0QB-9906V-18K5		Grit:#180					
0QB-9906V-32K5		Grit:#320					
0QB-9906V-40K5		Grit:#400					

ACCESSORIES

QD-905P

4 Pieces File Set clamshell pack
For QD-291 / 230
Blister+Card

20 pieces in one carton



QD-906P

5 Pieces File Set clamshell pack
For QD-221
Blister+Card

20 pieces in one carton

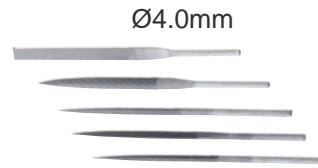

Blister+Card

QD-9209

9"-10T/14T: Reciprocating blade(slope)
For QD-501 / DRS-101 / DRS-102



QD-924P

24T Saw Blade Bi-Metal Material

10 pcs / box

Available with
QD-221 & QD-291



Blister+Card

QD-932P

32T Saw Blade Bi-Metal Material

10 pcs / box

Available with
QD-221 & QD-291

Blister+Card



QK-Series

Air Knife Blade

For QK-111 / QK-121 / QK-131 / PN-250 / PN-280

QK-111P51

QK-111P52

QK-111P53

QK-111P54

QK-111P50



QK-111P08

QK-2090

QK-2063

QK-2036



Blister

0QK-2030P - QK-111P08

0QK-1057P - QK-111P50

0QK-3018P - QK-111P51

0QK-3036P - QK-111P52

0QK-1008P - QK-111P54

SB-901

Auto Airchuck
One Touch Chuck Adaptor



SB-902

0-90° Angle Adjustable
One Touch Chuck Adaptor

Available with SB Series TYRE INFLATOR



SB-912

0-90° Angle Adjustable
One Touch Chuck Adaptor

Available with SB Series TYRE INFLATOR



SC-2A

Retainer



SC-2B

Quick Change Retainer

Available with
For SC-21 / SC-22 / SC-31 /
SC-34 SERIES



SC-415P CHISEL SET SC-425P CHISEL SET

SC-415 - Chisel Set / 175mmL / Round
SC-425 - Chisel Set / 175mmL / Hex

Available with
SC-331C / SC-341C / SC-332C / SC-342C / SC-211C /
SC-221C / SC-212C / SC-222C

-  Flat Chisel
SC-4101 Round / SC-4201 Hex
-  Cutting Chisel
SC-4102 Round / SC-4202 Hex
-  Tapered Punch
SC-4103 Round / SC-4203 Hex
-  Ripping Chisel
SC-4104 Round / SC-4204 Hex
-  Tail Pipe Cutter
SC-4105 Round / SC-4205 Hex



Blister+Card

SC-0206R **NEW**

6-Piece Air Hammer Drifts Set,
Length=177mm



SC-9501R **NEW**

1/2"Dr. Air hammer socket
adaptor, round shank



SC-9502R **NEW**

Air impact chisel : radius
milled R9, round shank



SC-9503R **NEW**

Air impact chisel : head Dia
25mm even, round shank



SC-9301R Air hammer drift punch
5.2mm, punching bag



SC-9302R Air hammer drift punch
6.5mm, punching bag



SC-9303R Air hammer drift punch
6.9mm, punching bag



SC-9304R Air hammer drift punch
7.7mm, punching bag



SC-9305R Air hammer drift punch
9.3mm, punching bag

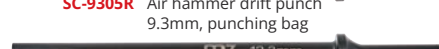

SC-9306R Air hammer drift punch
12.3mm, punching bag

ACCESSORIES

SN-9101 CHISEL FOR SN-31/SN-32 SERIES

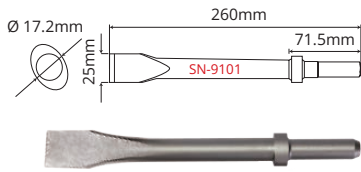

SN-9103 CHISEL FOR SN-31/SN-32 SERIES

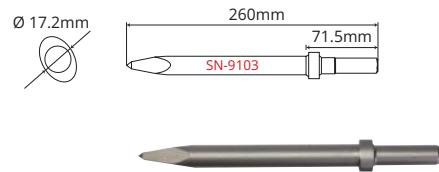

SN-9201 CHISEL FOR SN-31/SN-32 SERIES

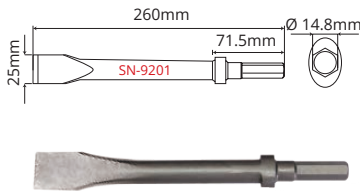

SN-9203 CHISEL FOR SN-31/SN-32 SERIES

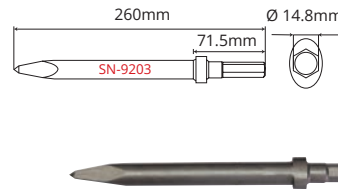

ACCESSORIES

SG-101 Lubrication Kit



SO-10 Lubrication



SO-10T Lubrication Kit



SW-12(1/4")

Mini Lubricator
Install on the air inlet to provide automatic lubrication 8c.c. lubricating oil capacity



SW-13(3/8")

Mini Lubricator
Install on the air inlet to provide automatic lubrication 8c.c. lubricating oil capacity



Box



Blister

SN-124

Needle Set

- SN-124
- (24 Needle Set) 3 x 180mm
- Available with SN-2124



SN-128

Needle Set

- SN-128
- (28 Needle Set) 3 x 180mm
- Available with SN-2128



BOX

SN-268

Needle Set

- SN-268
- (19 Needle Set) 3 x 180mm
- Available with SN-1268 / 2110 / 1368



SN-288

Needle Set

- SN-288
- (12 Needle Set) 3 x 125mm
- Available with SN-1288



SZ-212A

AIR REGULATOR

FEATURES

- Used to adjust the air inlet flow of pneumatic tools
- Easy to mount

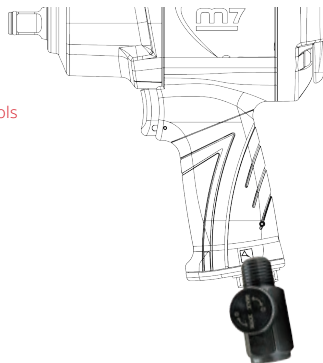

ZT-13-1 Forward ZT-13-2 Reverse

TORQUE TEST MACHINE

Torque testing for maintaining pneumatic impact wrenches

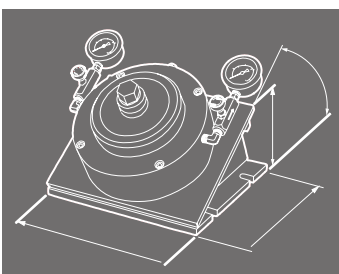

- Applicable Range : 50 ft-lb~2000 ft-lb(70Nm~2700Nm)
- Max. Torque : 3500 ft-lb(5000Nm)
- Applicable Size : SQ.DR-1/2"~3/4"
- Measuring Direction : ZT-13-1Forward/ZT-13-2Reverse
- Screw Size : M32
- Length x Width : 35cm x 30cm
- Weight : 49KG

AIR ADAPTOR QUICK COUPLINGS

AIR ADAPTOR QUICK COUPLINGS

SY-2001M

360° Rotatable Adaptor
Air Inlet 1/4"



SY-2002M

Air Regulator & 360° Rotatable Adaptor
Air Inlet 1/4"



SY-2011M

360° Rotatable Adaptor
Air Inlet 1/4"

High cost-performance ratio.



Blister+Card

SY-M SY-F Air Adaptor / Quick Couplings

Item No.	Thread Type	Thread Size	Type	Picture
SY-211M	Male	1/4" PT	Europe	
SY-211F	Female	1/4" PT		
SY-311M	Male	3/8" PT	Japan	
SY-311F	Female	3/8" PT		
SY-221M	Male	1/4" PT	U.S.A	
SY-321M	Male	3/8" PT		
SY-221F	Female	1/4" PT	U.S.A	
SY-321F	Female	3/8" PT		
SY-231M	Male	1/4" NPT	U.S.A	
SY-231F	Female	1/4" NPT		
SY-331M	Male	3/8" PT	U.S.A	
SY-331F	Female	3/8" PT		
SY-251M	Male	1/4" PT	France	
SY-351M	Male	3/8" PT		
SY-251F	Female	1/4" PT	France	
SY-351F	Female	3/8" PT		

Item No.	Thread Type	Thread Size	Type	Picture
SY-210M	Male	1/4" PT	Europe	
SY-210F	Female	1/4" PT		
SY-220M	Male	1/4" PT	Japan	
SY-320M	Male	3/8" PT		
SY-220F	Female	1/4" PT	Japan	
SY-320F	Female	3/8" PT		
SY-230M	Male	1/4" NPT	U.S.A	
SY-230F	Female	1/4" NPT		



Blister+Card

Composite Quick Coupling

Item No.	Thread Type	Thread Size	Type	Picture		
SY-0213M SY-0313M SY-0413M	Male	1/4" PT 3/8" PT 1/2" PT	Europe			
SY-0223M SY-0323M SY-0423M	Male	1/4" PT 3/8" PT 1/2" PT	Japan			
SY-0233M SY-0333M SY-0433M	Male	1/4" PT 3/8" PT 1/2" PT	U.S.A France			
Item No.	Thread Type	Thread Size	Type		Picture	
SY-1213F SY-1313F SY-1413F	Female	1/4" PT 3/8" PT 1/2" PT	Europe			
SY-1223F SY-1323F SY-1423F	Female	1/4" PT 3/8" PT 1/2" PT	Japan			
SY-1233F SY-1333F SY-1433F	Female	1/4" PT 3/8" PT 1/2" PT	U.S.A France			
Item No.	Thread Type	Thread Size	Type			Picture
SY-2213P SY-2313P SY-2413P	---	5x8 mm 6.5x10 mm 8x12 mm	Europe			
SY-2223P SY-2323P SY-2423P	---	5x8 mm 6.5x10 mm 8x12 mm	Japan			
SY-2233P SY-2333P SY-2433P	---	5x8 mm 6.5x10 mm 8x12 mm	U.S.A France			
Item No.	Thread Type	Thread Size	Type	Picture		
SY-3113H SY-3213H SY-3313H SY-3413H	---	10SH 1/4" 20SH 5/16" 30SH 3/8" 40SH 1/2"	Europe			
SY-3123H SY-3223H SY-3323H SY-3423H	---	10SH 1/4" 20SH 5/16" 30SH 3/8" 40SH 1/2"	Japan			
SY-3133H SY-3233H SY-3333H SY-3433H	---	10SH 1/4" 20SH 5/16" 30SH 3/8" 40SH 1/2"	U.S.A France			

POWER BIT

1/4" POWER BIT (PHILLIPS HEAD)

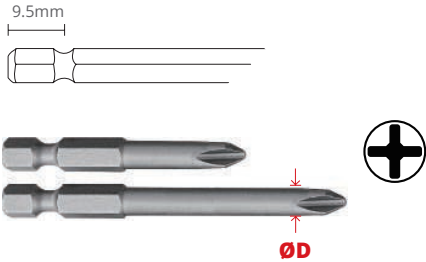

"OVERALL LENGTH(mm)"	SIZE	ITEM NO.	ØD(mm)	MOQ
25	2	MD50125P2A	6	300 Set
	2	MD50125P2R	6	
50	0	MD10150P0A	3	
	1	MD10150P1A	4.5	
	2	MD10150P2A	6	
70	3	MD10150P3A	6	
	1	MD10170P1A	4.5	
	2	MD10170P2A	6	
	3	MD10170P3A	6	

1/4" POWER BIT (POZIDRIV HEAD)

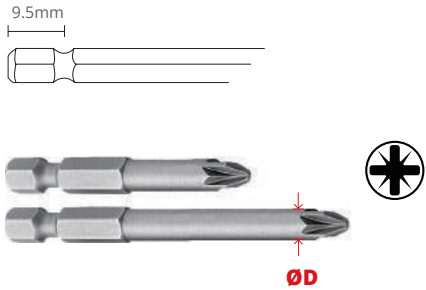

"OVERALL LENGTH(mm)"	SIZE	ITEM NO.	ØD(mm)	MOQ
25	2	MD50125Z2A	6	300 Set
50	0	MD10150Z0A	3	
	1	MD10150Z1A	4.5	
	2	MD10150Z2A	6	
70	3	MD10150Z3A	6	
	1	MD10170Z1A	4.5	
	2	MD10170Z2A	6	
	3	MD10170Z3A	6	

1/4" POWER BIT (STAR TAMPER HEAD)

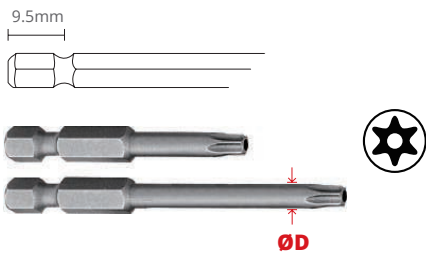

"OVERALL LENGTH(mm)"	SIZE	ITEM NO.	ØD(mm)	MOQ
90	10	MD10190TT10A	4	300 Set
	15	MD10190TT15A	4	
	20	MD10190TT20A	4.8	
	25	MD10190TT25A	4.8	
	30	MD10190TT30A	6	

"OVERALL LENGTH(mm)"	SIZE	ITEM NO.	ØD(mm)	MOQ
50	6	MD10150TT06A	3.2	300 Set
	7	MD10150TT07A	3.2	
	8	MD10150TT08A	3.2	
	9	MD10150TT09A	3.2	
	10	MD10150TT10A	4	
	15	MD10150TT15A	4	
	20	MD10150TT20A	4.8	
	25	MD10150TT25A	4.8	
	27	MD10150TT27A	6	
	30	MD10150TT30A	6	
40	MD10150TT40F	6.3		
70	6	MD10170TT06A	3.2	
	7	MD10170TT07A	3.2	
	8	MD10170TT08A	3.2	
	9	MD10170TT09A	3.2	
	10	MD10170TT10A	4	
	15	MD10170TT15A	4	
	20	MD10170TT20A	4.8	
	25	MD10170TT25A	4.8	
	27	MD10170TT27A	6	
	30	MD10170TT30A	6	
40	MD10170TT40F	6.3		
	45	MD10170TT45E	8	
	50	MD05170TT50E	9.1	

POWER BIT

1/4" POWER BIT

(DOUBLE PHILLIPS HEAD)

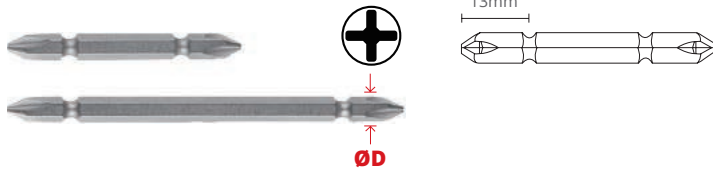

"OVERALL LENGTH(mm)"	SIZE	ITEM NO.	MOQ
65	1	MD10165P1P1A	300 Set
	2	MD10165P2P2A	
	3	MD10165P3P3A	
110	1	MD101110P1P1A	
	2	MD101110P2P2A	
	3	MD101110P3P3A	

1/4" POWER BIT

(HEX HEAD)

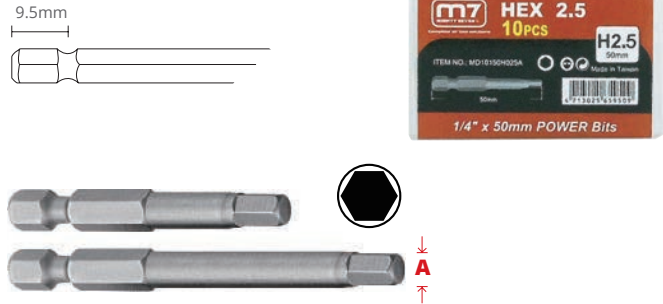

"OVERALL LENGTH(mm)"	A(mm)	ITEM NO.	MOQ
50	1.5	MD10150H015A	300 Set
	2	MD10150H020A	
	2.5	MD10150H025A	
	3	MD10150H030A	
	4	MD10150H040A	
	5	MD10150H050A	
	6	MD10150H060F	
	7	MD10150H070E	
	8	MD10150H080E	
	10	MD10150H100E	
70	1.5	MD10170H015A	300 Set
	2	MD10170H020A	
	2.5	MD10170H025A	
	3	MD10170H030A	
	4	MD10170H040A	
	5	MD10170H050A	
	6	MD10170H060F	
	7	MD10170H070E	
	8	MD10170H080E	
	10	MD05170H100E	

"OVERALL LENGTH(mm)"	A(mm)	ITEM NO.	MOQ
150	2.5	MD101150H025A	300 Set
	3	MD101150H030A	
	4	MD101150H040A	
	5	MD101150H050A	
	6	MD101150H060A	

1/4" POWER BIT

(STAR HEAD)

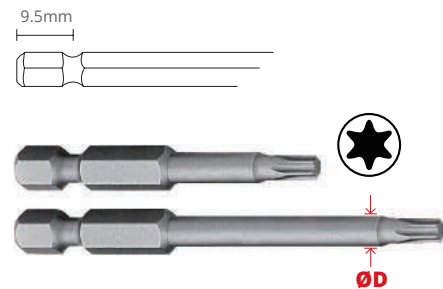

"OVERALL LENGTH(mm)"	SIZE	ITEM NO.	ØD(mm)	MOQ
50	6	MD10150T06A	3.2	300 Set
	7	MD10150T07A	3.2	
	8	MD10150T08A	3.2	
	9	MD10150T09A	3.2	
	10	MD10150T10A	4	
	15	MD10150T15A	4	
	20	MD10150T20A	4.8	
	25	MD10150T25A	4.8	
	27	MD10150T27A	6	
	30	MD10150T30A	6	
	40	MD10150T40F	7	
	45	MD10150T45E	8	
	50	MD05150T50E	9.1	
70	6	MD10170T06A	3.2	300 Set
	7	MD10170T07A	3.2	
	8	MD10170T08A	3.2	
	9	MD10170T09A	3.2	
	10	MD10170T10A	4	
	15	MD10170T15A	4	
	20	MD10170T20A	4.8	
	25	MD10170T25A	4.8	
	27	MD10170T27A	6	
	30	MD10170T30A	6	
	40	MD10170T40F	7	
	45	MD10170T45E	8	
	50	MD10170T50E	9.1	
45	MD08170T45E	8		
50	MD05170T50E	9.1		



"OVERALL LENGTH(mm)"	SIZE	ITEM NO.	ØD(mm)	MOQ
25	20	MD10125T20A	4.8	300 Set

MERCHANDISE

MERCHANDISE

ZC-201R T-SHIRT



SIZE	S	M	L	XL	2XL
	3XL	4XL	3L	4L	5L

ZC-201B T-SHIRT



SIZE	S	M	L	XL	2XL
	3XL	4XL	3L	4L	5L

ZC-501 T-SHIRT



SIZE	S	M	L	XL	2XL
	3XL	4XL	3L	4L	5L

ZB-812 ANTI-VIBRATION GLOVE



- Palm length :
- Distance between middle finger to bottom of the palm
- Palm width :
- Distance between left side and right side of the palm
- CE EN388 2121X

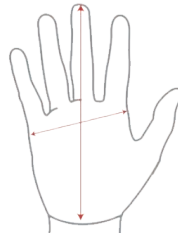

Item Description	length(cm)	wide(cm)
M	21.3	10.5
L	22	11
XL	22.7	11.5
XXL	23.4	12

ZB-814 HALF FINGER BLADE CUT RESISTANCE GLOVE



ZC-202-1 BASEBALL CAP



ZB-9156 LED PEN LIGHT

- LED x 4pcs
- No. 4 battery x 3pcs included



YA-0303 QUICK ASSEMBLY TENT

- Size : 3.3m
- Area : 9m²
- Weight : 22.5kg
- Top high : 3.5m



ZB-307 PEN



ZB-306 PEN(STYLUS)

- Pen with touch function



SE-1001 LED SLIM LIGHT



ZC-111

TOOL BAG

• 37 x 24 x 23cm



ZC-112

TOOL BAG(RUBBER BASE)

• 40 x 22 x 30cm



ZC-108

BAG



ZF-02

WING PROTECTOR COVER



ZF-01

WING PROTECTOR COVER



ZE-03

KNEELING PAD



ZC-301

STICKERS

• 100 x 112mm



ZB-211

MUG



ZM-101

27" AUTOMATIC UMBRELLA



ZC-302

STICKERS

• 200 x 110mm



ZC-303

STICKERS

• 199 x 106mm



ZC-304

STICKERS

• 288 x 156mm



User's Manual of Air Impact Wrench

Working environment:

- Using these tools in any potentially explosive environment is strictly prohibited.
- It is always recommended that these types of tools must be operated when standing on a solid or firm location.
- Always use these tools in a well ventilated area.
- Slipping, stumbling and falling are the major causes of potential serious injury, therefore, a clean and clutter free surface in the working area before operating the tools is strongly recommended.

Air supply and connection requirements:

- The maximum recommended air pressure during operation must not exceed 90 psi (6.3bar). Higher air pressure may create unsafe operating conditions for the tool and the user.
- The compressed air should be cooled and have a water filter installed at the outlet end of the compressor. Even with a water filter installed, some water may still condense in the piping or hose and will enter the tool mechanism causing premature damage to the tool. Therefore, it is recommended to install an air filter-lubricator device somewhere between the tool and the compressor.
- Always use an air compressor of the proper capacity to operate each tool.
- Clean the hose with a blast of compressed air before connecting the hose to the air tool. This will prevent both moisture and dust inside the hose from entering the tool and causing possible rust or malfunction.

Air Tool Repair Kits



M7 provides specialized repairing tools for your after market need

Ideal system connection

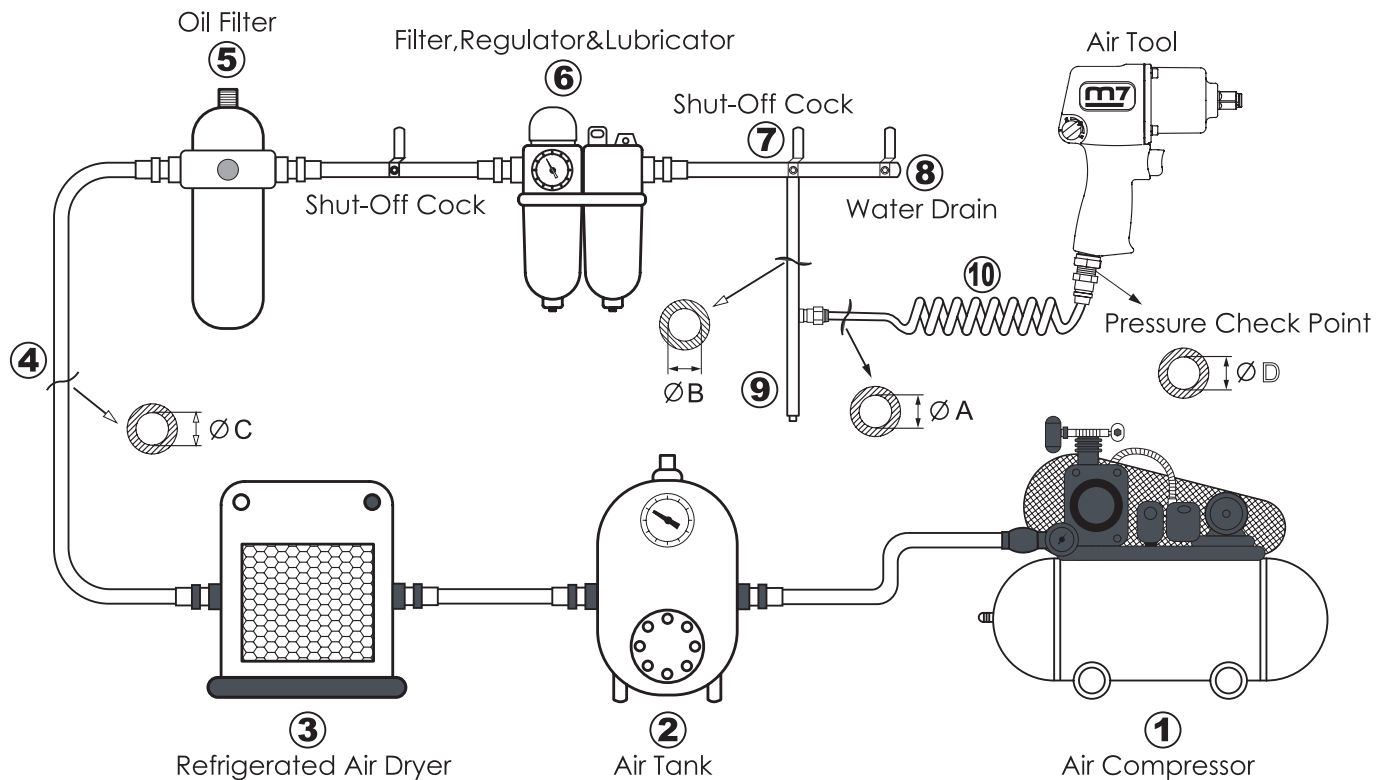

Piping diameters and length requirement:

- The diameter ΦA required for the inlet pipe 10 is recommended on the specification table.
- The diameter ΦB required for the branch pipe (from 7 to 9) should be 2 times as large as ΦA . $\Phi B = 2 \times \Phi A$
- The diameter ΦC required for the primary air supply (from 1 to 8) should be 3 times as large as ΦA . $\Phi C = 3 \times \Phi A$
- The length for the inlet pipe 10 should be less than 15 feet (4.5m).

Impact Wrench

Problem (phenomenon)	Possible Cause	Recommended solution
<ol style="list-style-type: none"> 1. The tool runs automatically or tool will not shut off. 2. Torque decreases slightly. 3. Sound of air leaking. 	<ol style="list-style-type: none"> 1. Dust jam. 	<ol style="list-style-type: none"> 1. Clean and remove the dust from the air inlet. 2. Clean the throttle valve. 3. Apply a few drops of recommended pneumatic oil into the air inlet. 4. Pull the trigger and run for several seconds to get rid of the dust.
<ol style="list-style-type: none"> 1. Severe torque loss, but will still run at full free speed, 2. Tool will not run. 	<ol style="list-style-type: none"> 1. The rotor blades may be damaged, 2. The screws may be loose. 3. The reverse button (knob) may be out off position. 4. Some component(s) in motor housing or hammer housing may be worn off. 	<ol style="list-style-type: none"> 1. Check and replace new ones, if necessary. 2. Tighten all loose screws. 3. Adjust the button. 4. Check and replace them, if necessary.
<ol style="list-style-type: none"> 1. Air leaks from hammer housing or rear cover. 	<ol style="list-style-type: none"> 1. The screws may be loose. 2. The gasket seal may be broken. 	<ol style="list-style-type: none"> 1. Tighten all loose screws. 2. Replace it.

Note: The consumable parts are the rotor blades, anvil and hammer.

Ratchet Wrench

Problem (phenomenon)	Possible Cause	Recommended solution
<ol style="list-style-type: none"> 1. The tool runs automatically or tool will not shut off. 2. Torque decreases slightly. 3. Sound of air leaking. 	<ol style="list-style-type: none"> 1. Dust jam. 	<ol style="list-style-type: none"> 1. Clean and remove the dust from the air inlet. 2. Clean the throttle valve. 3. Apply a few drops of recommended pneumatic oil into the air inlet. 4. Pull the trigger and run for several seconds to get rid of the dust.
<ol style="list-style-type: none"> 1. Severe torque loss, but will still run at full free speed, 2. Tool will not run. 	<ol style="list-style-type: none"> 1. The rotor blades may be damaged, 2. The screws may be loose. 3. The reverse button (knob) may be out off position. 4. Some component(s) in motor housing or hammer housing may be worn off. 	<ol style="list-style-type: none"> 1. Check and replace new ones, if necessary. 2. Tighten all loose screws. 3. Adjust the button. 4. Check and replace them, if necessary.

Note: The consumable parts are the rotor blades, gears and ratchet anvil.

Die Grinder

Problem (phenomenon)	Possible Cause	Recommended solution
<ol style="list-style-type: none"> 1. The tool runs automatically or tool will not shut off. 2. Torque decreases slightly. 3. Sound of air leaking. 	<ol style="list-style-type: none"> 1. Dust jam. 2. Trigger may be damaged! 	<ol style="list-style-type: none"> 1. Clean to remove the dust from the air inlet. 2. Clean the throttle valve. 3. Apply a few drops of recommended pneumatic oil into the air inlet. 4. Push trigger and run for several seconds to get rid of the dust. 5. Inspect the trigger, correct or replace the related component when necessary.
<ol style="list-style-type: none"> 1. Severe torque loss, but will still run at full free speed, 2. Tool will not run. 	<ol style="list-style-type: none"> 1. The rotor blades may be damaged, 2. The screws may be loose. 3. The Air Regulator may not be in correct position. 4. The Collet Nut may be loose. 	<ol style="list-style-type: none"> 1. Check and replace with new ones, if necessary. 2. Tighten all loose screws. 3. Check and correct. 4. Check and tighten.

Note: The consumable parts are the rotor blades, bearings and collet.

Air Cutting Off Tool

Problem (phenomenon)	Possible Cause	Recommended solution
<ol style="list-style-type: none"> 1. The tool runs automatically or tool will not shut off. 2. Torque decreases slightly. 3. Sound of air leaking. 	<ol style="list-style-type: none"> 1. Dust jam. 2. Trigger may be damaged! 	<ol style="list-style-type: none"> 1. Clean and remove the dust from the air inlet. 2. Clean the throttle valve. 3. Apply a few drops of recommended pneumatic oil into the air inlet. 4. Push trigger and run for several seconds to get rid of the dust. 5. Inspect the trigger, correct or replace the related component when necessary.
<ol style="list-style-type: none"> 1. Severe torque loss, but will still run at full free speed, 2. Tool will not run. 	<ol style="list-style-type: none"> 1. The rotor blades may be damaged, 2. The screws may be loose. 3. The Air Regulator may not be in correct position. 	<ol style="list-style-type: none"> 1. Check and replace with new ones, if necessary. 2. Tighten all loose screws. 3. Check and correct.

Note: The consumable parts are the rotor blades and bearings.

Air angle Grinder

Problem (phenomenon)	Possible Cause	Recommended solution
<ol style="list-style-type: none"> 1. The tool runs automatically or tool will not shut off. 2. Torque decreases slightly. 3. Sound of air leaking. 	<ol style="list-style-type: none"> 1. Dust jam. 2. Trigger may be damaged! 	<ol style="list-style-type: none"> 1. Clean and remove the dust from the air inlet. 2. Clean the throttle valve. 3. Apply a few drops of recommended pneumatic oil into the air inlet. 4. Push trigger and run for several seconds to get rid of the dust. 5. Inspect the trigger, correct or replace the related component when necessary.
<ol style="list-style-type: none"> 1. Severe torque loss, but will still run at full free speed. 2. Tool will not run. 	<ol style="list-style-type: none"> 1. The rotor blades may be damaged, 2. The screws may be loose. 3. The bevel gears may not have enough grease. 4. The bevel gears may be worn off. 	<ol style="list-style-type: none"> 1. Check and replace new ones, if necessary. 2. Tighten all loose screws. 3. Apply some multiple-purpose grease. 4. Replace them.

Note: The consumable parts are the rotor blades and bearings.

Belt Sander

Problem (phenomenon)	Possible Cause	Recommended solution
<ol style="list-style-type: none"> 1. The tool runs automatically or tool will not shut off. 2. Torque decreases slightly. 3. Sound of air leaking. 	<ol style="list-style-type: none"> 1. Dust jam. 	<ol style="list-style-type: none"> 1. Clean and remove the dust from the air inlet. 2. Clean the throttle valve. 3. Apply a few drops of recommended pneumatic oil into the air inlet. 4. Pull the trigger and run for several seconds to get rid of the dust.
<ol style="list-style-type: none"> 1. Severe torque loss, but will still run at full free speed. 2. Tool will not run. 	<ol style="list-style-type: none"> 1. The rotor blades may be damaged. 2. The screws may be loose. 3. The belt may not be seated correctly. 4. The bearings may be damaged. 	<ol style="list-style-type: none"> 1. Check and replace with new ones, if necessary. 2. Tighten all loose screws. 3. Adjust it. 4. Replace them.

Note: The consumable parts are the rotor blades and bearings.

Air Sander

Problem (phenomenon)	Possible Cause	Recommended solution
<ol style="list-style-type: none"> 1. The tool runs automatically or tool will not shut off. 2. Torque decreases slightly. 3. Sound of air leaking. 	<ol style="list-style-type: none"> 1. Dust jam. 2. Trigger may be damaged! 	<ol style="list-style-type: none"> 1. Clean and remove the dust from the air inlet. 2. Clean the throttle valve. 3. Apply a few drops of recommended pneumatic oil into the air inlet. 4. Pull the trigger and run for several seconds to get rid of the dust.
<ol style="list-style-type: none"> 1. Severe torque loss, but will still run at full free speed. 2. Tool will not run. 	<ol style="list-style-type: none"> 1. The rotor blades may be damaged, 2. The pad may not be correct. 3. The screws may be loose. 	<ol style="list-style-type: none"> 1. Check and replace with new ones, if necessary. 2. Check and replace with the correct one. 3. Tighten all loose screws.

Note: The consumable parts are the rotor blades and bearings.

Air Shear

Problem (phenomenon)	Possible Cause	Recommended solution
<ol style="list-style-type: none"> 1. The tool runs automatically or tool will not shut off. 2. Torque decreases slightly. 3. Sound of air leaking. 	<ol style="list-style-type: none"> 1. Dust jam. 	<ol style="list-style-type: none"> 1. Clean and remove the dust from the air inlet. 2. Clean the throttle valve. 3. Apply a few drops of recommended pneumatic oil into the air inlet. 4. Pull the trigger and run for several seconds to get rid of the dust.
<ol style="list-style-type: none"> 1. Severe torque loss, but will still run at full free speed, 2. Tool will not run. 	<ol style="list-style-type: none"> 1. The rotor blades may be damaged, 2. The cutting blades may not be sharp enough. 3. The cutting blades may not be in the correct position. 4. The lock screws for cutting blades may be loose. 	<ol style="list-style-type: none"> 1. Check and replace with new ones, if necessary. 2. Check and replace with new ones, if necessary. 3. Check and adjust them. 4. Check and tighten.

Note: The consumable parts are the rotor blades and bearings.

Air Saw

Problem (phenomenon)	Possible Cause	Recommended solution
<ol style="list-style-type: none"> 1. The tool runs automatically or tool will not shut off. 2. Torque decreases slightly. 3. Sound of air leaking. 	<ol style="list-style-type: none"> 1. Dust jam. 2. Trigger may be damaged! 	<ol style="list-style-type: none"> 1. Clean and remove the dust from the air inlet. 2. Clean the throttle valve. 3. Apply a few drops of recommended pneumatic oil into the air inlet. 4. Pull the trigger and run for several seconds to get rid of the dust.
<ol style="list-style-type: none"> 1. Severe torque loss, but will still run at full free speed. 2. Tool will not run. 	<ol style="list-style-type: none"> 1. The rotor blades may be damaged. 	<ol style="list-style-type: none"> 1. Check and replace with new ones, if necessary.
<ol style="list-style-type: none"> 1. Severe decrease in reciprocating speed. 	<ol style="list-style-type: none"> 1. The drive motor may be dirty. 	<ol style="list-style-type: none"> 1. Cleaning required.

Note: The consumable parts are the rotor blades and bearings.

Problem (phenomenon)	Possible Cause	Recommended solution
<p>Air Drill</p> <ol style="list-style-type: none"> 1. The tool runs automatically or tool will not shut off. 2. Torque decreases slightly. 3. Sound of air leaking. 	<ol style="list-style-type: none"> 1. Dust jam. 	<ol style="list-style-type: none"> 1. Clean and remove the dust from the air inlet. 2. Clean the throttle valve. 3. Apply a few drops of recommended pneumatic oil into the air inlet. 4. Pull the trigger and run for several seconds to get rid of the dust.
<ol style="list-style-type: none"> 1. Severe torque loss, but will still run at full free speed. 2. Tool will not run. 	<ol style="list-style-type: none"> 1. The rotor blades may be damaged, 2. The keyless chuck may be damaged. 	<ol style="list-style-type: none"> 1. Check both possibilities and replace with new ones, if necessary.
<p>Note: The consumable parts are the rotor blades and bearings.</p>		
<p>Air Screwdriver</p> <ol style="list-style-type: none"> 1. The tool runs automatically or tool will not shut off. 2. Torque decreases slightly. 3. Sound of air leaking. 	<ol style="list-style-type: none"> 1. Dust jam. 	<ol style="list-style-type: none"> 1. Clean and remove the dust from the air inlet. 2. Clean the throttle valve. 3. Apply a few drops of recommended pneumatic oil into the air inlet. 4. Pull the trigger and run for several seconds to get rid of the dust.
<ol style="list-style-type: none"> 1. Severe torque loss, but will still run at full free speed, 2. Tool will not run. 	<ol style="list-style-type: none"> 1. The rotor blades may be damaged, 2. The screws may be loose. 3. The Reverse Knob may be damaged or not in the right position. 4. The impact mechanism may be damaged. 	<ol style="list-style-type: none"> 1. Check both possibilities and replace with new ones, if necessary. 2. Tighten all the loose screws. 3. Check and adjust, or replace with a new one if necessary. 4. Check and replace with a new set, if necessary.
<p>Note: The consumable parts are the rotor blades and bearings.</p>		
<p>Air Hammer</p> <ol style="list-style-type: none"> 1. The tool runs automatically or tool will not shut off. 2. Torque decreases slightly. 3. Sound of air leaking. 	<ol style="list-style-type: none"> 1. Dust jam. 	<ol style="list-style-type: none"> 1. Clean and remove the dust from the air inlet. 2. Clean the throttle valve. 3. Apply a few drops of recommended pneumatic oil into the air inlet. 4. Pull the trigger and run for several seconds to get rid of the dust.
<ol style="list-style-type: none"> 1. The tool doesn't work 	<ol style="list-style-type: none"> 1. The piston may be jammed or damaged. 2. The size of chisel may not be correct. 	<ol style="list-style-type: none"> 1. Check and replace the related component when necessary. 2. Check and replace with the correct one.
<p>Note: The consumable parts are the throttle valve and piston.</p>		
<p>Hydraulic Riveter</p> <ol style="list-style-type: none"> 1. The tool runs automatically or tool will not shut off. 2. Power decreases slightly. 3. Sound of air leaking. 	<ol style="list-style-type: none"> 1. Dust jam. 	<ol style="list-style-type: none"> 1. Clean and remove the dust from the air inlet. 2. Clean the throttle valve. 3. Apply a few drops of recommended pneumatic oil into the air inlet. 4. Pull the trigger and run for several seconds to get rid of the dust.
<ol style="list-style-type: none"> 1. The tool doesn't work 	<ol style="list-style-type: none"> 1. The size of rivet may not be suitable. 2. The size of rivet nose may not be correct. 	<ol style="list-style-type: none"> 1. Check and use the correct ones. 2. Check and replace with the correct one!
<p>Note: The consumable parts are the rivet nose, jaw housing, front housing and spring.</p>		

Note:

For more details about the above recommended solutions, please refer to the use'r Manual attached along with each product.

ALPHABETIC INDEX

A

AD-101	136
AD-201	136
AD-22/23/24	128
AD-303-41	135
AD-305-41	135
AD-306	136
AD-306DB	136
AD-307	135
AD-308	135
AD-309	135
AD-316	136
AD-35	134
AD-351	135
AD-3511P	134
AD-3511T	134
AD-36	134
AD-361	135
AD-431	136

D

DB-1825	15
DB-1850P	15
DC-101	15
DC-18A	15
DC-201	15
DCS-101/DCS-101A	22
DCCS-101	26
DD-101/DD-101A	19
DDWV-104	25
DFL-101	24
DG-501/DG-501A	21
DG-585/DG-585502A	22
DGG-102/DGG-102A	23
DGM-101	27
DGM-901	27
DGM-902	27
DGM-903	27
DGM-904	27
DGS-101	25
DH-101/DH-101A	19
DHG-101/DHG-101A	23
DHT-101	26
DJS-101/DJS-101A	21
DLB-102	26
DOM-101/DOM-101A	21
DOS-501/DOS-501A	22
DPW-101	25
DR-102/DR-102A	23
DRH-101/DRH-101A	20
DRS-101/DRS-101A	20
DRS-102/DRS-102A	20
DS-10202A	18
DS-201/DS-201A	18
DS-202/DS-202A	18
DS-203/DS-203A	19
DST-101	27
DW-1840/DW-18502A	16
DW-401/DW-401A	16
DW-402/DW-402A	16
DW-404/DW-404A	17
DW-406/DW-406A	17
DW-601/DW-601A	17
DWL-101	24
DWL-102	24

G

GBI-403030	113
GBI-406060	113
GBI-434340	113
GDI-403030	113
GDI-406060	113
GDI-434340	113
GMD-205050	111
GMD-210200	111
GMD-220400	111
GMI-206006	111
GMI-215015	111
GMI-225025	111
GMS-203006	111
GMS-207015	111
GMS-212025	111
GTA-201030	109
GTA-306135	109
GTA-406135	109
GTA-410200	109
GTA-417340	109
GTA-606060	109
GTA-610100	109
GTA-810100	109
GTA-930	111
GTA-940	111
GTA-941	111
GTB-201030	110
GTB-306135	110
GTB-410200	110
GTB-417340	110
GTF-203030	110
GTF-313135	110
GTF-420200	110
GTF-434340	110
GTW-201030	112
GTW-306135	112
GTW-406135	112
GTW-410200	112
GTW-417340	112
GTW-606060	112
GTW-610100	112
GTW-810100	112
GTW-930	111
GTW-940	111
GTW-941	111

J

JC-0415[SET]	94
JC-0424[SET]	94
JC-202	94
JC-405	94
JC-410	94
JC-412	94
JC-424	94
JC-435	94
JC-491	94
JC-602	94
JC-640	94
JC-641	94
JC-680	94

M

MA211M	118
MA211S	118
MA231M	119
MA231S	119
MA311M	119
MA311S	119
MA331M	120
MA331S	120
MA401M	120
MA401S	120
MA4030	117
MA4031M85	117
MA411M	121
MA411S	121
MA412M1719	130
MA412M2122	130
MA412S2426	130
MA42006M	117
MA42006S	117
MA42011S	117
MA42015M	117
MA42026	117
MA431M	122
MA431S	122
MA4550M50	116
MA611M	123
MA611S	123
MA631M	124
MA631S	124
MA641M	129
MA641S	129
MA643M	129
MA8050	117
MA811M	125
MA811S	125
MA831M	126
MA831S	126
MA841M	129
MA841S	129
MA843M	129
MA911M	127
MA911S	127
MA931M	128
MA931S	128
MB34012S	114
MB34013M	114
MB35012S	115
MB35013M	115
MB371S	133
MB42011M	114
MB43015M	115
MB44008M	116
MB44008S	116
MB44013S	114
MB44014M	114
MB45010M	115
MB45013S	115
MB45014M	115
MB46008R	116
MB46010R	116
MB47010M	116
MB61008M	114
MB61016M	114
MB62010M	114
MB63008M	115
MB63008S	115

M

MB64008M	114
MB64008M1	114
MB64008S	114
MB64008SP	114
MB65008M	115
MB65008M1	115
MB65008S	115
MB65008S1	115
MB66006M	116
MB66006S	116
MB67006M	116
MB81009M/S	116
MB85008M	116
MD10150H Series	149
MD10150P Series	148
MD10150T Series	149
MD10150TT Series	148
MD10165P1P Series	149
MD50125P2A	148
MD50125P2R	148
MD50125Z2A	148
ME011N	116
ME221	130
ME2711	130
ME271M08-7	130
ME271M10-7	130
ME321	130
ME3711	130
ME371M	132
ME371S	132
ME371T	133
ME382	130
ME384	130
ME4050	131
ME421	131
ME422	131
ME4711	130
ME471M	132
ME471S	132
ME471T	133
ME472S	133
ME473M	133
ME483	130
ME486	130
ME486H	130
ME621	131
ME6711	130
ME6711H	130
ME671M	132
ME671S	132
ME673M	133
ME684	130
ME684H	130
ME688	130
ME688H	130
ME821	131
ME8711	130
ME8711H	130
ME871M	133
ME886	130
ME886H	130
ME889	130
ME904	131
ME906	131
ME908	131
ME9711	130

ALPHABETIC INDEX

N

NC-0208[SET]	95
NC-0415-KIT	40
NC-0425-KIT	40
NC-0615-KIT	40
NC-2210N[SET]	95
NC-3210	28
NC-3231Q	28
NC-3410	28
NC-3610Q	28
NC-3810	28
NC-3812	28
NC-3831	28
NC-398	28
NC-4117	29
NC-4130	29
NC-4210	29
NC-4210N	29
NC-4213	29
NC-4217	29
NC-4223	29
NC-4230	30
NC-4230Q	30
NC-4232Q	30
NC-4232Q-KIT	40
NC-4233Q	30
NC-4233Q-KIT	40
NC-4233QH	30
NC-4233TL	30
NC-4236	30
NC-4236Q	31
NC-4240	30
NC-4255PVC	31
NC-4255Q	31
NC-4255Q-KIT	40
NC-4255Q-41-KIT	41
NC-4255QH	31
NC-4255QH-KIT	40
NC-4255QP	31
NC-4256	31
NC-4256Q	31
NC-4256Q-2	31
NC-4258	32
NC-4265Q	31
NC-4277Q	32
NC-4299Q	32
NC-4600	32
NC-4600-14-KIT	41
NC-4600-KIT	41
NC-4610	32
NC-4610N	32
NC-4610Q	32
NC-4630	32
NC-4630Q	33
NC-4650	33
NC-4650-KIT	41
NC-4650H	33
NC-4670Q	33
NC-4811	33
NC-488	33
NC-498	33
NC-6113	34
NC-6123	34
NC-6201	34
NC-6210Q	34
NC-6215	34
NC-6216	34

N

NC-6216PVC	34
NC-6217	34
NC-6218	34
NC-6218-6	34
NC-6225	34
NC-6226	34
NC-6233Q	35
NC-6236	35
NC-6236-KIT	41
NC-6236Q	35
NC-6236Q-KIT	41
NC-6255Q	35
NC-6255Q-KIT	41
NC-6255QH	35
NC-6256Q	35
NC-6266	35
NC-6266-6	35
NC-6266H	35
NC-6610Q	35
NC-8211	36
NC-8212	36
NC-8216	36
NC-8217	36
NC-8219	36
NC-8221	36
NC-8226	36
NC-8226Q	36
NC-8232	36
NC-8237	36
NC-8237-6	36
NC-8242	36
NC-8242-8	37
NC-8252	37
NC-8260	37
NC-8260-6	37
NC-8262	37
NC-8266P	37
NC-8266P-6	37
NC-8266S	37
NC-8266S-6	37
NC-8266S-8	37
NC-8311	37
NC-8322	38
NC-8331	38
NC-8331-6	38
NC-8332X	38
NC-8332X-6	38
NC-8342	38
NC-8343	38
NC-8343-8	38
NC-8351	37
NC-8362	39
NC-8372	39
NC-8382	39
NC-8382-8	39
NC-9223	39
NC-9243	39
NC-REPAIR KIT	137
NE-0357	45
NE-0405 KIT	46
NE-0413/NE-0413S KIT	45
NE-251	42
NE-251R	42
NE-261	42
NE-2803	42
NE-2900	43

N

NE-2905	43
NE-321	42
NE-3305	43
NE-3310	43
NE-332	44
NE-332T	44
NE-343	44
NE-351	42
NE-351R	42
NE-352	44
NE-361	42
NE-362	44
NE-3803	42
NE-3808	44
NE-383	44
NE-3900	43
NE-3901	43
NE-399	29
NE-421	42
NE-4305	43
NE-4310	43
NE-432	44
NE-432T	44
NE-443	44
NE-451	42
NE-451R	42
NE-462	45
NE-462T	45
NE-4808	44
NE-4815	45
NE-483	44
NE-488	45
NE-4901	43
NE-499	29
NE-499N	29
NE-REPAIR KIT	137

P

PA-111	87
PA-201	87
PA-201V	87
PA-203N	87
PA-211	87
PA-211TS	88
PA-301	87
PA-301D	87
PA-301L	87
PA-301V	87
PA-312V	87
PA-321	87
PA48PB06T	89
PA-9048	89
PA-9048P	89
PA-9048PT	89
PA-9064	89
PA-9064P	89
PA-MC	87
PB-1305	88
PB-1308	88
PB-1310	88
PB-1312	88
PB-2402	88
PB-2601	88
PB-9006	89
PB-9006P	89

P

PB-9006PT	89
PB-9010	89
PB-9010P	89
PC-2010	68
PC-901	68
PE-MC	87
PN-150	67
PN-180	67
PN-250	67
PN-280	67

Q

QA-0115 A/B[SET]	50
QA-0207 A/B[SET]	50
QA-0215 A/B[SET]	50
QA-0615 A/B[SET]	50
QA-101 A/B	47
QA-110 A/B	47
QA-111 A/B	47
QA-116 A/B	47
QA-1211/QA-1221 A/B	47
QA-131 A/B	48
QA-141 A/B	48
QA-141L A/B	48
QA-143 A/B	48
QA-151 A/B	48
QA-163 A/B	48
QA-163L A/B	48
QA-1710 A/B	48
QA-210 A/B	49
QA-211 A/B	49
QA-2211/QA-2221 A/B	47
QA-231Q A/B	49
QA-241 A/B	49
QA-311 A/B	49
QA-313 A/B	49
QA-315 A/B	49
QA-412 A/B	51
QA-421 A/B	51
QA-431 A/B	51
QA-432 A/B	51
QA-441 A/B	51
QA-4507 A/B	51
QA-511	51
QA-611 A/B	49
QA-6205 A/B	49
QA-632Q A/B	50
QA-633Q A/B	50
QA-651N[SET]	95
QA-681 A/B	50
QA-688 A/B	50
QB-0618[SET]	95
QB-0808	98
QB-0808U	98
QB-1004	52
QB-104X/QB-105X	52
QB-114X/QB-115X	52
QB-117	52
QB-124/125	52
QB-134X	52
QB-135X	52
QB-144X	53
QB-145X	53
QB-154X	52
QB-155X	52

Q

QB-164X	53
QB-165X	53
QB-177	53
QB-179	53
QB-185	53
QB-187	53
QB-192/QB-192L	53
QB-193/QB-193L	53
QB-194	54
QB-194CN	54
QB-194L	54
QB-195-85/120	54
QB-195CN	54
QB-195L-85/120	54
QB-197Q	54
QB-199S/M	54
QB-20203	58
QB-2925	55
QB-2925L	55
QB-311	56
QB-312	56
QB-313	56
QB-321	56
QB-322	56
QB-322C	56
QB-322RC	56
QB-324	56
QB-325N [SET]	56
QB-41	59
QB-42	57
QB-43	58
QB-45	59
QB-46	57
QB-47	58
QB-48012	61
QB-48111	61
QB-48112	61
QB-48211	61
QB-48212	61
QB-49602	57
QB-51602	59
QB-51612	59
QB-52	57
QB-53	58
QB-54	59
QB-55	57
QB-56	58
QB-57602	59
QB-57642	60
QB-58502/QB-58602	57
QB-58642/QB-58542	60
QB-59602	58
QB-59642	60
QB-623	54
QB-7214S/M	55
QB-7215S/M	55
QB-7245S/M	55
QB-7315 S/M	55
QB-801	138
QB-802	98
QB-802T	98
QB-802TU	98
QB-802U	98
QB-812	98
QB-812T	98
QB-812TU	98

Q

QB-812U	98
QB-904	138
QB-905	138
QB-907	138
QB-911[SET]	140
QB-912[SET]	140
QB-913	138
QB-914	138
QB-9211A/B[SET]	141
QB-9213A/B[SET]	141
QB-922/QB-923	138
QB-9302/QB-9303	137
QB-9305/QB-9306	137
QB-9303	138
QB-9303K04	140
QB-9315/QB-9355	137
QB-9316/QB-9356	137
QB-9320	138
QB-9327/QB-9366	137
QB-9337M/QB-9337S	138
QB-9345/QB-9346	137
QB-94 Series	139
QB-9400	98
QB-9401	138
QB-9411	98
QB-9412	98
QB-9414	98
QB-9415	98
QB-9434	138
QB-9434U	138
QB-9444	138
QB-9444U	138
QB-9507	139
QB-95 Series	139
QB-9702	139
QB-9703	139
QB-9712K	138
QB-9713K	138
QB-9742K12	140
QB-9742K20	140
QB-9743K12	140
QB-9743K20	140
QB-974K12	140
QB-9752K07	140
QB-9762K07	140
QB-9773K19	140
QB-9802	138
QB-9803	138
QB-9933V	141
QC-213	64
QC-213T	64
QC-234	64
QC-234T	64
QC-253	64
QC-254	64
QC-264	64
QC-333	64
QC-512	63
QD-221	65
QD-230	65
QD-242	65
QD-260	65
QD-291N	65
QD-321	65
QD-501	65
QD-905P	142

Q

QD-906P	142
QD-924P	65
QD-9209	142
QD-932P	65
QE-2130	68
QE-2133	68
QE-2137	68
QE-2143	68
QE-231	68
QE-323N[SET]	96
QE-324	69
QE-331	69
QE-332	69
QE-333	69
QE-334	69
QE-341	71
QE-342	71
QE-343	71
QE-344	71
QE-431	69
QE-432	69
QE-433	69
QE-434	69
QE-441	71
QE-442	71
QE-443	72
QE-532	70
QE-533	70
QE-542	72
QE-543	72
QE-6010/QE-6010L	74
QE-6011/QE-6011L	74
QE-6012/QE-6012L	75
QE-6020/QE-6020L	74
QE-6021/QE-6021L	74
QE-6022/QE-6022L	75
QE-6030/QE-6030L	74
QE-6110/QE-6110L	74
QE-6111/QE-6111L	75
QE-6112/QE-6112L	75
QE-6120/QE-6120L	74
QE-6121/QE-6121L	75
QE-6122/QE-6122L	75
QE-6130/QE-6130L	74
QE-624	73
QE-624QA[SET]	73
QE-633	70
QE-634	70
QE-831	70
QE-833	70
QE-841	72
QE-843	72
QE-845	72
QE-924	73
QE-933	70
QE-935	70
QE-936	70
QG-102	66
QG-103	66
QG-202	66
QK-111	66
QK-111T	66
QK-112	67
QK-112N	67
QK-121	66
QK-131	66

Q

QK-901	67
QK-902	67
QK-903	67
QK-904	67
QK-SERIES	142
QM-1125	100
QP-111	62
QP-113	62
QP-123	62
QP-123QP	62
QP-212N[SET]	96
QP-213N[SET]	96
QP-215	62
QP-223N[SET]	96
QP-307 S/M	62
QP-317	63
QP-327 S/M	63
QP-335	63
QP-415	96
QT-102	97
QT-103	97
QT-112T	97
QT-203/113	97
QT-203T	97
QT-303	97

R

RA-101/101C	77
RA-102	77
RA-105	77
RA-111	29
RA-1131	77
RA-1132	79
RA-1141	77
RA-1142	79
RA-1151	77
RA-1162	79
RA-1232	77
RA-1242	77
RA-1272	78
RA-201	78
RA-2161	77
RA-2242	78
RA-2272	78
RA-301	79
RA-30SERIES	80
RA-302	79
RA-31SERIES	80
RA-40SERIES	80
RA-402	80
RA-41SERIES	80
RA-50SERIES	80
RA-505N[SET]	97
RA-51SERIES	80
RA-606	78
RA-608	78
RA-801	79
RA-801ET	77
RA-802	79
RA-811	80

ALPHABETIC INDEX

S

SA-2015	105
SA-3215/SA-3315	105
SA-4320	105
SB-201	99
SB-2031	99
SB-2131	99
SB-215	99
SB-3030	99
SB-3038	99
SB-3130	99
SB-4031	99
SB-4151	99
SB-422	99
SB-423	99
SB-501	99
SB-710	99
SB-901	143
SB-902	143
SB-912	143
SC-005	101
SC-0206R	143
SC-0320	100
SC-05C[SET]	83
SC-06C[SET]	83
SC-211C	82
SC-221C	82
SC-212C	82
SC-222C	82
SC-2A/2B	143
SC-331C	82
SC-332C	82
SC-33C/34C	83
SC-341C	82
SC-342C	82
SC-371	82
SC-371C	82
SC-415P/SC-425P	143
SC-9501R	143
SC-9502R	143
SC-9503R	143
SD-22	105
SD-23	105
SD-24	105
SE-1001	150
SE-1025	101
SE-2012	101
SE-3001	101
SF-306	136
SF-604	136
SF-605	136
SG-101	144
SG-400/SG-500	93
SG-400C	93
SG-401/SG-501	93
SG-405	93
SG-407	93
SG-902	93
SG-910	93
SG-910S	93
SG-911	93
SG-912	93
SG-912L	93
SH-1001	136
SJ-1650T	90
SJ-1830F	90
SJ-1850F	90

S

SJ-BNF1664	90
SJ-C1830F	90
SJ-CN55	92
SJ-CN57	92
SJ-CN65	92
SJ-CN70	92
SJ-CN90	92
SJ-FN90E	90
SJ-TN64	90
SK-1010	97
SK-1131	97
SM-0503	100
SM-0813	100
SM-111R	100
SN-1032	83
SN-124/SN-268	145
SN-128/SN-288	145
SN-1268	85
SN-1288	85
SN-1368	85
SN-2110	85
SN-2124	85
SN-2128	85
SN-31 series	84
SN-32 series	84
SN-9101	83
SN-9103	83
SN-9201	83
SN-9203	83
SO-10	144
SO-10T	144
SP-101	81
SP-102	81
SP-103	81
SP-104	81
SP-105	81
SP-111	81
SP-112	81
SP-113	81
SP-212	81
SP-213	81
SP-3030	81
SP-3050	81
SP-3070	81
SP-3090	81
SP-31050	81
SP-31200	81
SP-3150	81
SP-3220	81
SP-3300	81
SP-3400	81
SP-3500	81
SP-3600	81
SP-3700	81
SP-3900	81
SQ-0217	101
SR-2001-KIT	101
SR-2101	101
ST-10C521	135
ST-10C522S	135
SU-8016	91
SU-9025	91
SU-9040	91
SU-A3218S	91
SU-A3222S	91
SU-A3518S	91

S

SU-A3522S	91
SU-C1022J	90
SU-C422J	90
SU-H3218S	91
SU-H3222S	91
SU-H3518S	91
SU-H3522S	91
SV-1240	103
SV-1260	103
SV-1360	103
SV-1460	103
SV-1660	103
SV-1860	103
SV-2220	103
SV-2260/2280	103
SV-2360/2380	103
SV-2431	103
SV-2460	104
SV-2660/2860	104
SV-3260/3360	104
SV-3460	104
SV-3660/3860	104
SW-12	104
SW-13	104
SX-1201	102
SX-1615	102
SX-1618	102
SX-2101	102
SX-3101	102
SX-3102	102
SX-3103	102
SX-3111	102
SX-3112	102
SX-3202	102
SX-3203	102
SX-3301	102
SX-4101	102
SY-0213M	147
SY-0223M	147
SY-0233M	147
SY-0313M	147
SY-0323M	147
SY-0333M	147
SY-0413M	147
SY-0423M	147
SY-0433M	147
SY-1213F	147
SY-1223F	147
SY-1233F	147
SY-1313F	147
SY-1323F	147
SY-1333F	147
SY-1413F	147
SY-1423F	147
SY-1433F	147
SY-2001M	146
SY-2002M	146
SY-2011M	146
SY-210F	146
SY-210M	146
SY-211F	146
SY-211M	146
SY-220F	146
SY-220M	146
SY-2213P	147
SY-221F	146

S

SY-221M	146
SY-2223P	147
SY-2233P	147
SY-230F	146
SY-230M	146
SY-2313P	147
SY-231F	146
SY-231M	146
SY-2323P	147
SY-2333P	147
SY-2413P	147
SY-2423P	147
SY-2433P	147
SY-251F	146
SY-251M	146
SY-311F	146
SY-311M	146
SY-3113H	147
SY-3123H	147
SY-3133H	147
SY-320F	146
SY-320M	146
SY-3213H	147
SY-321F	146
SY-321M	146
SY-3223H	147
SY-3233H	147
SY-331F	146
SY-331M	146
SY-3313H	147
SY-3323H	147
SY-3333H	147
SY-3413H	147
SY-3423H	147
SY-3433H	147
SY-351F	146
SY-351M	146
SZ-212A	145

T

TB-205025N	107
TB-305025N	107
TB-320110N	107
TB-420210N	107
TB-450350N	107
TB-610060N	107
TB-615080N	107
TB-620100N	107
TD-202025	107
TD-305050	107
TD-410100	107
TD-420200	107
TD-610060	107
TE-205025N	106
TE-225250N	106
TE-305025N	106
TE-320110N	106
TE-428210N	106
TE-442210N	106
TE-450350N	106
TE-81N	106
TE-82N	106
TE-83N	106

T

TE-84N	106
TE-85N	106
TF-310080N	108
TF-430250N	108
TI-2105025KIT	108
TI-4204020KIT	108
TM-0416	106
TM-0418	106
TM-0428-1	106
TM-0428-2	106
TM-0618	106
TS-320100N	108
TS-440250N	108
TW-210222	106
TW-310552	106
TW-411102	106
TW-412202	106
TW-611602	107
TW-611802	107
TW-612102	107

W

WG-202N[SET]	101
--------------	-----

Y

YA-0303	150
---------	-----

Z

ZB-211	151
ZB-306	150
ZB-307	150
ZB-812	150
ZB-814	150
ZB-9156	150
ZC-108	151
ZC-111	151
ZC-112	151
ZC-201R	150
ZC-201B	150
ZC-501	150
ZC-202-1	150
ZC-301	151
ZC-302	151
ZC-303	151
ZC-304	151
ZE-03	151
ZF-01	151
ZF-02	151
ZM-101	151
ZT-13-1	145
ZT-13-2	145
ZT-31	80

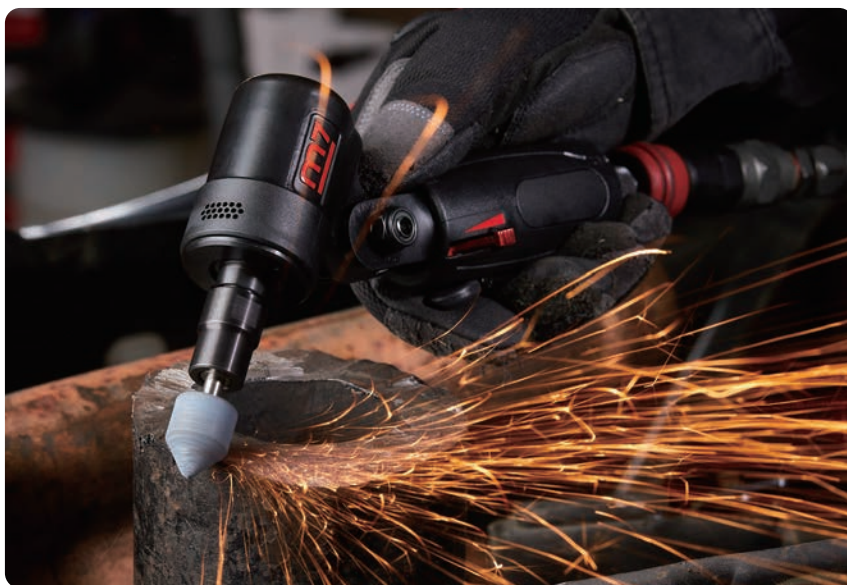



***SMALL. LIGHT. QUIET.
POWERFUL!***

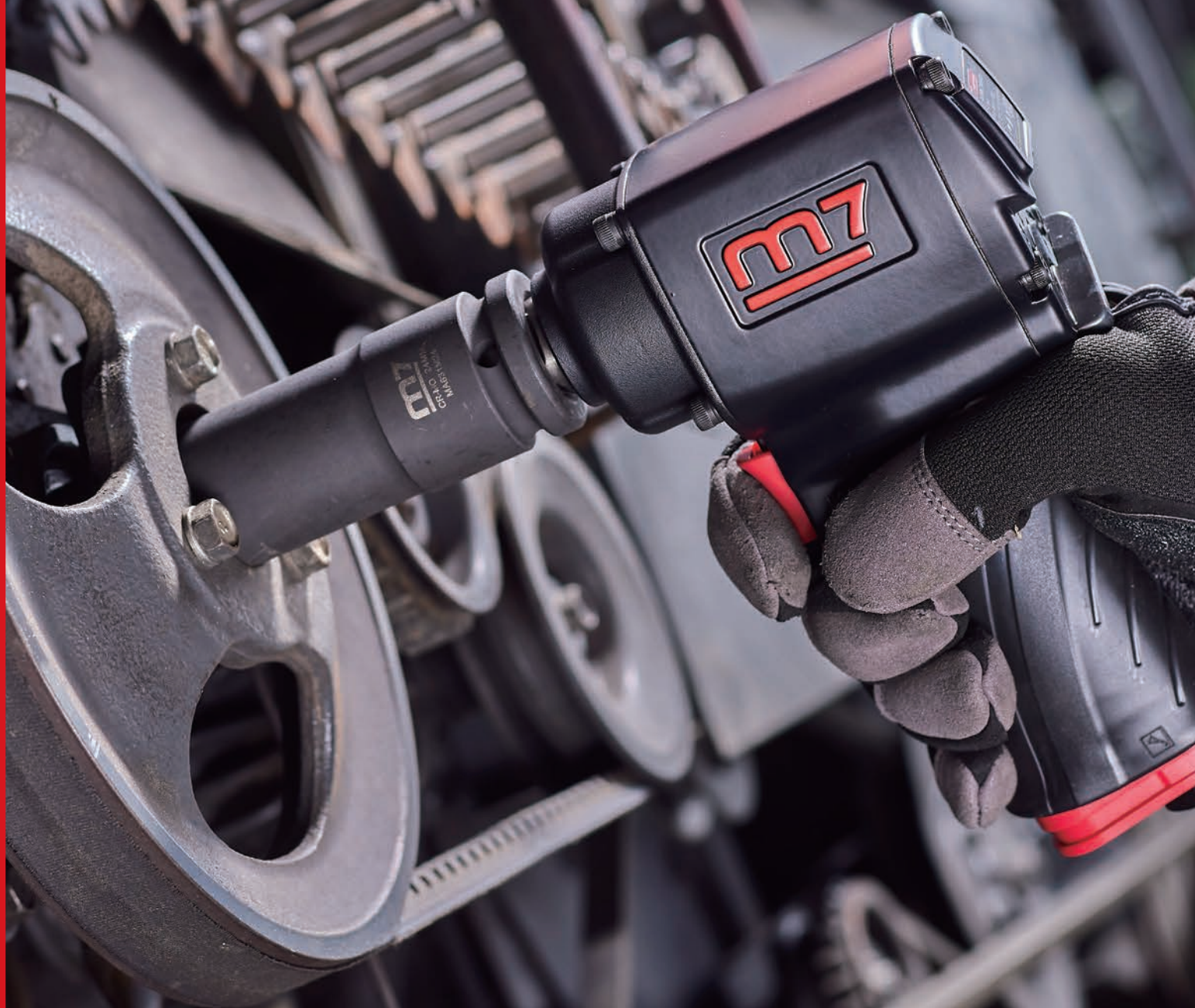



2025 - 2026

Cordless | Pneumatic Solutions

CONSTRUCTION | CARPENTRY | AUTO MAINTENANCE | METAL WORK



Mighty Seven International